

CREATIVE USE OF

SDX



FIRST EDITION
November 1987

© 1987 Simmons Electronics Ltd.

Alban Park
Hatfield Road
St Albans
Herts
AL4 0JH
U.K.

Telephone : 0727- 36191
Telex : 291326 HEXDRM G
Fax : 0727- 41755

All rights reserved.

No part of this publication may be reproduced, transmitted, transcribed, stored in a retrieval system, or translated into any language in any form by any means, without the written permission of Simmons Electronics Ltd.

Creative Use of SDX _____

SECTION 1

Packing List

Having unpacked your SDX System, you should check that all the component parts are present. A list of each configuration is contained in this section.

Before You Start

Once you have checked that all the relevant hardware has been supplied, you must check the Voltage and Fuse ratings.

SECTION 2

Setting-Up

This section covers the activities involved in setting up the Drum Hardware, connecting Pads to the Console and from the Console to suitable Amplification. If you can't wait to hear SDX connect a pair of headphones and skip this section for now.

SECTION 3

Getting Started

After introducing Disks this section describes how to Power-up and load the System Disk. User Controls are then discussed and used to select your first SDX Digital Drum Kit.

SECTION 4

Using SDX

This Section gives you an insight into how the various levels exist within SDX. Each of the Screens and Windows are explained in detail, showing you the intuitive, graphic way in which Kits, Drums and Samples can be manipulated.

SECTION 5

Reference

Once you have used SDX a couple of times and are familiar with most of it's functions you may only require this Manual as a supplement to the built-in Information System. This section is designed to allow you to quickly find detailed information about any Screen or Menu.

SECTION 6

XSEQ - Percussion Sequencer

Future Upgrade

SECTION 7

XEDIT - Sample Editor

Future Upgrade

SECTION 8

Interfaces

To Be Released

SECTION 9

Sound Disks

SDX is supplied with 6 Sound Disks, which have been compiled by some of the world's top drummers and producers. An attempt is made to describe each of the Kits, Drums and Samples contained on these disks.

SECTION 10

Appendix

The Appendix contains the MIDI Implementation Chart and Technical Specification.

SCREEN MAPS

Where Am I ?

On the back of each Contents page in the Using and Reference Sections is a 'Screen Map'. These should help you understand how SDX's Screens are connected together. The double arrow icon shows you where you are on the Map, for each Screen.

Section 1

INTRODUCING SDX

SDX Concept	1 - 1	Before You Start	1 - 7
Packing List	1 - 3	Important	1 - 7
SDX 10 Piece Kit	1 - 3	Connecting to the Mains	1 - 7
SDX 7 Piece Kit	1 - 4	Changing the Fuse	1 - 7
SDX 5 Piece Kit	1 - 5	Looking After SDX	1 - 8
SDX Console Only	1 - 6		
Optional	1 - 6		

Section 2

SETTING UP

Assembling The Kit	2 - 1	Sampler In / Snare & Stereo Out	2 - 15
Assembling a 10 Piece Kit	2 - 1	Pedals	2 - 15
Assembling a 7 Piece Kit	2 - 4	MIDI	2 - 15
Assembling a 5 Piece Kit	2 - 7	SMPTE	2 - 16
Console Stand Assembly	2 - 9	SCSI	2 - 16
		Video Out	2 - 16
Connecting Up	2 - 11	Amplification	2 - 17
SDX 10 Piece Kit	2 - 11	Amplification	2 - 17
SDX 7 Piece Kit	2 - 12	SDC200	2 - 17
SDX 5 Piece Kit	2 - 13	Mixers	2 - 17
Pad Inputs	2 - 14	Headphones	2 - 18
Voice Outputs	2 - 14		

Section 3

GETTING STARTED

Introducing Disks	3 - 1	Help System Window	3 - 8
Disk Drive	3 - 1	Key Pads	3 - 8
Disk Etiquette	3 - 1	L/R Pedals	3 - 8
Disk Protection	3 - 2	Loading A Kit	3 - 9
Power Up	3 - 3	Loading Kits from Sound Disks	3 - 9
Power-Up	3 - 3	Load All Kits	3 - 10
Optional Hard Disk	3 - 3	Loading from a Hard Disk	3 - 10
Kit Select Screen	3 - 5	Disk Versus Memory	3 - 11
System Kit	3 - 5	Disk Versus Memory	3 - 11
User Controls	3 - 6	Internal Memory Options	3 - 11
Tracker Ball	3 - 6	Internal Hard Disk Drive	3 - 11
Select Buttons	3 - 6	Memory Information	3 - 12
Pull Down Menus	3 - 6	Disk Information	3 - 13
Windows	3 - 8		

USING SDX : KIT MIXER SCREEN

Selecting the Kit Mixer Screen	4 - 1	Loading other Kits	4 - 6
Other 8	4 - 2	Load Kit from Memory	4 - 6
Adjusting Length	4 - 2	Loading Kits from Disk	4 - 7
Adjusting Tune	4 - 2	Special Mixer Functions	4 - 8
Adjusting Pan	4 - 2	Initialise Mixer	4 - 8
Adjusting Volume	4 - 3	Set All Mute/Solo Off	4 - 8
Mute and Solo Switches	4 - 3	Set Pot & Slider Ranges	4 - 8
Muting a Channel	4 - 3	Leaving the Kit Mixer Screen	4 - 9
Soloing a Channel	4 - 3	Save	4 - 9
Saving Changes	4 - 4	Lose	4 - 9
Save Kit	4 - 4	Cont	4 - 9
Save Kit As	4 - 4		
Alphanumeric Keyboard	4 - 4		

USING SDX : KIT CONFIGURATION SCREEN

What is a Kit ?	4 - 11	MIDI Channel	4 - 23
Selecting the Kit Configuration Screen	4 - 13	Assigning a MIDI Channel	4 - 23
Other 8	4 - 13	Special MIDI Functions	4 - 23
Selecting the Pad Type	4 - 14	Saving your Changes	4 - 25
Pad 1 - Bass	4 - 14	Save Kit	4 - 25
Pad 2 - Snare	4 - 14	Save Kit As	4 - 25
Pad 3 - Rim	4 - 14	Alphanumeric Keyboard	4 - 25
Pads 4 -16 Tom, Symbal, Pitched or Hi-Hat.	4 - 15	Loading other Kits	4 - 26
Assigning Drums	4 - 16	Loading Kits from Memory	4 - 26
Selecting Drums from Memory	4 - 16	Loading Kits from Disk	4 - 27
Selecting Drums from Disk	4 - 17	Moving to the Kit Mixer Screen	4 - 28
Voice Assignment	4 - 18	Editing Drums	4 - 29
Voice Rotation	4 - 18	What is a Drum ?	4 - 29
Voice Robbing	4 - 18	Drum Samples	4 - 29
Assigning Voices to a Pad	4 - 18	Drum Head	4 - 29
Individual Voice Outputs	4 - 18	Making your own Drums	4 - 31
Special Voice Functions	4 - 19	Sample Assign	4 - 31
Edit MIDI	4 - 21	Drum Head	4 - 31
MIDI Note	4 - 22	Leaving the Kit Configuration Screen	4 - 32
Assigning a MIDI Note to a Pad	4 - 22		
Selecting a MIDI Note Range	4 - 22		

Section 4.3

USING SDX : DRUM SAMPLE ASSIGN SCREEN

<ul style="list-style-type: none"> Selecting the Sample Assign Screen 4 - 33 <ul style="list-style-type: none"> Dynamic Levels 4 - 34 Dynamic Level Meter 4 - 34 Medium Threshold Handle 4 - 34 Hard Threshold Handle 4 - 34 Strike Position 4 - 34 Current Dynamic/Position Marker 4 - 35 Pitch Offset 4 - 35 Level Offset 4 - 35 Loading other Drums 4 - 35 <ul style="list-style-type: none"> Load Drums from Memory 4 - 36 Loading Drums from Disk 4 - 37 Assigning Samples 4 - 37 <ul style="list-style-type: none"> Selecting Samples from Memory 4 - 37 Assigning Groups of Samples 4 - 39 Special Assign Function 4 - 39 Selecting Samples from Disk 4 - 39 Assigning a different Sample to the Centre 4 - 40 Saving your Changes 4 - 41 <ul style="list-style-type: none"> Save Drum 4 - 41 Save Drum As 4 - 41 	<ul style="list-style-type: none"> Leaving the Sample Assign Screen 4 - 42 <ul style="list-style-type: none"> Save 4 - 42 Lose 4 - 42 Cont 4 - 42 Bass, Rim and Pitched Sample Assigning 4 - 43 <ul style="list-style-type: none"> Bass Drum Sample Assign 4 - 43 Rim Sample Assign 4 - 44 Pitched Drum Sample Assign 4 - 45 Hi-Hat Sample Assigning 4 - 46 Pedal Positions 4 - 46 Pedal Position Indicator 4 - 46 Sizzle Threshold Handle 4 - 47 Open Threshold Handle 4 - 47 Strike Position 4 - 47 Pedal Trigger 4 - 47 Assigning Samples 4 - 48 Making your own Samples 4 - 48 <ul style="list-style-type: none"> New Sample 4 - 48 Edit Sample 4 - 48
---	--

Section 4.4

USING SDX : DRUM HEAD SCREEN

<ul style="list-style-type: none"> What is a Drum Head ? 4 - 49 <ul style="list-style-type: none"> Dynamic Curve 4 - 50 Position Curve 4 - 50 Pitch Surface 4 - 50 Brightness Surface 4 - 50 Resonance Surface 4 - 50 Noise Surface 4 - 51 Level Surface 4 - 51 Pan Surface 4 - 51 Length Surface 4 - 51 SampleStart 4 - 51 Selecting the Drum Head Screen 4 - 52 <ul style="list-style-type: none"> Surface Stack 4 - 52 Surface Number 4 - 52 Surface Type 4 - 53 Surface Range 4 - 53 Dynamic Curve 4 - 53 Position Curve 4 - 53 Loading other Drums 4 - 54 <ul style="list-style-type: none"> Loading Drums from Memory 4 - 54 Loading Drums from Disk 4 - 55 	<ul style="list-style-type: none"> What is a Surface ? 4 - 56 Opening A Surface Window 4 - 61 Envelopes 4 - 62 <ul style="list-style-type: none"> Envelope Shape 4 - 62 Preset Envelope Shapes 4 - 62 Flip Envelope 4 - 62 Other Envelopes 4 - 62 Copying Envelope Shapes 4 - 63 Closing the Surface Window 4 - 63 Adding an New Surface 4 - 63 <ul style="list-style-type: none"> Adding an Initial Surface 4 - 63 Adding an Envelope Surface 4 - 63 Adjusting the Surface Range 4 - 64 Pitch Surfaces 4 - 64 Brightness Surfaces 4 - 65 Resonance Surfaces 4 - 66 Noise Surfaces 4 - 67 Level Surfaces 4 - 68 Pan Surfaces 4 - 69
---	--

Creative Use of SDX

Length Surface	4 - 70	Leaving the Drum Head Screen	4 - 73
SampleStart Surface	4 - 71	Save	4 - 73
Moving to the Sample Assign Screen	4 - 72	Lose	4 - 74
Saving your Changes	4 - 72	Cont	4 - 74
Save Drum	4 - 72		
Save Drum As	4 - 72		

Section 4.5

USING SDX : SAMPLER SCREEN

What is a Sample ?	4 - 75	Editing A New Sample	4 - 86
Sound Transmission	4 - 75	Marker Select	4 - 86
Sound Waveforms	4 - 75	Truncate Pointers	4 - 87
Sound Sampling	4 - 75	Truncate Start Point	4 - 87
Selecting the Sampler Screen	4 - 77	Truncate End Point	4 - 87
Making a New Sample	4 - 77	Loop Pointers	4 - 89
Sample Length	4 - 78	Loop Start Point	4 - 89
Sample Rate	4 - 78	Loop End Point	4 - 90
Sample Name	4 - 80	Looping Samples	4 - 90
Sample Start Point	4 - 80	Finding Good Loop Points	4 - 90
Sample End Point	4 - 80	Looping Options	4 - 91
Connecting Audio	4 - 80	Special Functions	4 - 94
Preview	4 - 80	Clear Samples Not In Window	4 - 94
Zoom Window	4 - 81	Reverse Samples In Window	4 - 94
Peak Meter	4 - 82	Maximise Sample Amplitude	4 - 95
Threshold Adjust	4 - 82	Utility Functions	4 - 95
Sample	4 - 82	Editing Other Samples	4 - 95
Sample Window	4 - 83	Edit Sample from Memory	4 - 96
Creating Another New Sample	4 - 83	Edit Sample from Disk	4 - 97
Save	4 - 84	From Sample Assign Screen	4 - 97
Lose	4 - 84	Sample Protection	4 - 98
Cont	4 - 84	Leaving the Sampler Screen	4 - 99
New Sample Window	4 - 84	Save	4 - 99
Saving your New Sample	4 - 84	Lose	4 - 99
Save Sample	4 - 84	Cont	4 - 99
Save Sample As	4 - 85		
Deleting Samples	4 - 85		
Deleting Samples from Memory	4 - 85		
Deleting Samples from Disk	4 - 86		

Section 4.6

USING SDX : DISK OPERATIONS WINDOW

<p>Other Disk Operations Window 4 - 101</p> <p>Selecting the Current Device 4 - 102</p> <p>Selecting the Disk Name 4 - 103</p> <p>Load Operations 4 - 104</p> <p style="padding-left: 20px;">Load One 4 - 104</p> <p style="padding-left: 20px;">Load All 4 - 105</p> <p>Save Operations 4 - 106</p> <p style="padding-left: 20px;">Save One 4 - 106</p> <p style="padding-left: 20px;">Save All 4 - 107</p> <p>Delete Operations 4 - 108</p> <p style="padding-left: 20px;">Delete One 4 - 108</p> <p style="padding-left: 20px;">Delete All 4 - 109</p>	<p>Rename Operation 4 - 111</p> <p style="padding-left: 20px;">Rename One 4 - 111</p> <p>Format Operation 4 - 113</p> <p style="padding-left: 20px;">Formatting a Disk 4 - 114</p> <p>Copy Operations 4 - 116</p> <p style="padding-left: 20px;">Copy Options 4 - 116</p> <p style="padding-left: 20px;">Copy One 4 - 117</p> <p style="padding-left: 20px;">Copy All 4 - 119</p>
---	---

Section 4.7

USING SDX : CONTROL PANEL WINDOW

<p>Control Panel 4 - 121</p> <p style="padding-left: 20px;">Damp dt 4 - 122</p> <p style="padding-left: 20px;">Damp pt 4 - 122</p> <p style="padding-left: 20px;">Damper 4 - 122</p> <p style="padding-left: 20px;">Hat 4 - 122</p> <p style="padding-left: 20px;">Mod 4 - 122</p> <p style="padding-left: 20px;">Quit 4 - 122</p> <p>AutoTrigger 4 - 123</p> <p style="padding-left: 20px;">Dynamic 4 - 124</p> <p style="padding-left: 20px;">Position 4 - 124</p> <p style="padding-left: 20px;">Tempo 4 - 124</p> <p style="padding-left: 20px;">Last Dyn 4 - 124</p> <p style="padding-left: 20px;">Last Pos 4 - 124</p> <p style="padding-left: 20px;">Clear 4 - 124</p> <p style="padding-left: 20px;">Start/Stop 4 - 124</p> <p style="padding-left: 20px;">Quit 4 - 124</p> <p style="padding-left: 20px;">MidiWatch 4 - 125</p>	<p>MIDIWatch 4 - 125</p> <p style="padding-left: 20px;">Quit 4 - 125</p> <p style="padding-left: 20px;">Key Pad Mode 4 - 125</p> <p>Key Pad Modes 4 - 126</p> <p style="padding-left: 20px;">Mode 1 4 - 126</p> <p style="padding-left: 20px;">Mode 2 4 - 127</p> <p style="padding-left: 20px;">Mode 3 4 - 127</p> <p style="padding-left: 20px;">Mode 4 4 - 127</p> <p style="padding-left: 20px;">Mode 5 4 - 127</p> <p style="padding-left: 20px;">C. Panel 4 - 127</p> <p style="padding-left: 20px;">Quit 4 - 127</p>
--	---

REFERENCE : KIT SELECT SCREEN

Screen Parameters	5 - 1	Special Menu	5 - 3
Kit Icon	5 - 1	Easy Sampling	5 - 3
Active Kit	5 - 1		
Kit Select Menu	5 - 2	Kit Edit Menu	5 - 3
Info on SDX	5 - 2	Kit Mixer	5 - 3
Info on Kit Select	5 - 2	Kit Configuration	5 - 3
Control Panel	5 - 2	Welcome	5 - 3
Memory Menu	5 - 2		
Delete Kit	5 - 2		
Clear Memory	5 - 2		
Info	5 - 2		
Disk Menu	5 - 2		
Save Kit	5 - 2		
Load Kit	5 - 2		
Load All Kits	5 - 2		
Other	5 - 2		
Info	5 - 3		

REFERENCE : KIT MIXER SCREEN

Screen Parameters	5 - 5	Disk Menu	5 - 7
Kit Name	5 - 5	Save Kit	5 - 7
Other 8	5 - 5	Save Kit As	5 - 7
Length Pot	5 - 5	Load Kit	5 - 7
Tune Pot	5 - 5	Delete Kit	5 - 7
Pan Pot	5 - 6	Other	5 - 7
Vol Slider	5 - 6	Info	5 - 7
Mute Switch	5 - 6		
Solo Switch	5 - 6	Special Menu	5 - 8
Kit Mixer Menu	5 - 6	Initialise Mixer	5 - 8
Info on SDX	5 - 6	Set All Mutes/Solos Off	5 - 8
Info on Kits	5 - 6	Pots & Slider Ranges	5 - 8
Info on Kit Mixer	5 - 6		
Control Panel	5 - 6	Next Menu	5 - 8
Memory Menu	5 - 6	Kit Mixer	5 - 8
Save Kit	5 - 6	Kit Configuration	5 - 8
Save Kit As	5 - 6	Quit	5 - 8
Load Kit	5 - 7		
Delete Kit	5 - 7		
Info	5 - 7		

Section 5.3

REFERENCE : KIT CONFIGURATION SCREEN

<p>Screen Parameters 5 - 9</p> <p style="padding-left: 20px;">Kit Name 5 - 9</p> <p style="padding-left: 20px;">Other 8 5 - 9</p> <p style="padding-left: 20px;">Pad Type 5 - 9</p> <p style="padding-left: 20px;">Drum Assign 5 - 9</p> <p style="padding-left: 20px;">Voice Assign 5 - 10</p> <p>Edit MIDI 5 - 10</p> <p style="padding-left: 20px;">Edit MIDI 5 - 10</p> <p style="padding-left: 20px;">MIDI Note 5 - 10</p> <p style="padding-left: 20px;">MIDI Channel 5 - 10</p> <p style="padding-left: 20px;">MIDI Program 5 - 11</p> <p>Kit Configuration Menu 5 - 11</p> <p style="padding-left: 20px;">Info on SDX 5 - 11</p> <p style="padding-left: 20px;">Info on Kits 5 - 11</p> <p style="padding-left: 20px;">Info on Kit Configuration 5 - 11</p> <p style="padding-left: 20px;">Info on Voice Assignment 5 - 11</p> <p style="padding-left: 20px;">Control Panel 5 - 11</p> <p>Memory Menu 5 - 11</p> <p style="padding-left: 20px;">Save Kit 5 - 11</p> <p style="padding-left: 20px;">Save Kit As 5 - 11</p> <p style="padding-left: 20px;">New Kit 5 - 11</p> <p style="padding-left: 20px;">Load Kit 5 - 11</p> <p style="padding-left: 20px;">Delete Kit 5 - 11</p> <p style="padding-left: 20px;">Info 5 - 11</p>		<p>Disk Menu 5 - 12</p> <p style="padding-left: 20px;">Save Kit 5 - 12</p> <p style="padding-left: 20px;">Save Kit As 5 - 12</p> <p style="padding-left: 20px;">Load Kit 5 - 12</p> <p style="padding-left: 20px;">Delete Kit 5 - 12</p> <p style="padding-left: 20px;">Other 5 - 12</p> <p style="padding-left: 20px;">Info 5 - 12</p> <p>Special Voice Menu 5 - 12</p> <p style="padding-left: 20px;">Pad Type as Default 5 - 12</p> <p style="padding-left: 20px;">Pad Type All Pitched 5 - 13</p> <p style="padding-left: 20px;">Voice Assign as Default 5 - 13</p> <p style="padding-left: 20px;">Voice Assign 1 to 1 5 - 13</p> <p style="padding-left: 20px;">Voice Assign All to All 5 - 13</p> <p>Special MIDI Menu 5 - 13</p> <p style="padding-left: 20px;">Pad Type as Default 5 - 13</p> <p style="padding-left: 20px;">Pad Type All Pitched 5 - 14</p> <p style="padding-left: 20px;">MIDI Notes as Default 5 - 14</p> <p style="padding-left: 20px;">MIDI Channels as Default 5 - 14</p> <p style="padding-left: 20px;">MIDI Note Decimal 5 - 14</p> <p style="padding-left: 20px;">MIDI Note Chromatic 5 - 14</p> <p>Next Menu 5 - 14</p> <p style="padding-left: 20px;">Kit Mixer 5 - 14</p> <p style="padding-left: 20px;">Kit Configuration 5 - 14</p> <p style="padding-left: 20px;">Quit 5 - 14</p>
--	--	--

Section 5.4

REFERENCE : DRUM SAMPLE ASSIGN SCREEN

<p>Screen Parameters 5 - 15</p> <p style="padding-left: 20px;">Drum Name 5 - 15</p> <p style="padding-left: 20px;">Sample Assign 5 - 15</p> <p style="padding-left: 20px;">Pitch Offset 5 - 16</p> <p style="padding-left: 20px;">Level Offset 5 - 16</p> <p style="padding-left: 20px;">Dynamic Level Meter 5 - 16</p> <p style="padding-left: 20px;">Medium Threshold Handle 5 - 16</p> <p style="padding-left: 20px;">HardThreshold Handle 5 - 16</p> <p style="padding-left: 20px;">Current Dynamic/Position 5 - 16</p> <p>Bass, Rim and Pitched Drums 5 - 16</p> <p>Hi-Hat Sample Assign 5 - 17</p> <p style="padding-left: 20px;">Sample Assign 5 - 17</p> <p style="padding-left: 20px;">Pitch Offset 5 - 17</p> <p style="padding-left: 20px;">Level Offset 5 - 17</p> <p style="padding-left: 20px;">Pedal Position Indicator 5 - 17</p> <p style="padding-left: 20px;">Open Threshold Handle 5 - 18</p> <p style="padding-left: 20px;">Sizzle Threshold Handle 5 - 18</p> <p style="padding-left: 20px;">Pedal Trigger Threshold 5 - 18</p>		<p>Drum Sample Assign Menu 5 - 18</p> <p style="padding-left: 20px;">Info on SDX 5 - 18</p> <p style="padding-left: 20px;">Info on Drums 5 - 18</p> <p style="padding-left: 20px;">Info on Sample Assigning 5 - 18</p> <p style="padding-left: 20px;">Control Panel 5 - 18</p> <p>Memory Menu 5 - 18</p> <p style="padding-left: 20px;">Save Drum 5 - 18</p> <p style="padding-left: 20px;">Save Drum As 5 - 18</p> <p style="padding-left: 20px;">New Drum 5 - 18</p> <p style="padding-left: 20px;">Load Drum 5 - 18</p> <p style="padding-left: 20px;">Delete Drum 5 - 18</p> <p style="padding-left: 20px;">Info 5 - 19</p>
---	--	---

Creative Use of SDX

Disk Menu	5 - 19	Special Menu	5 - 19
Save Drum	5 - 19	Set All as Soft/Outer	5 - 19
Save Drum As	5 - 19		
Load Drum	5 - 19	Next Menu	5 - 20
Delete Drum	5 - 19	Drum Sample Assign	5 - 20
Other	5 - 19	Drum Head	5 - 20
Info	5 - 19	Quit	5 - 20

Section 5.5

REFERENCE : DRUM HEAD SCREEN

Screen Parameters	5 - 21	Disk Menu	5 - 23
Drum Name	5 - 21	Save Drum	5 - 23
Surface Assign	5 - 21	Save Drum As	5 - 23
Surface Range	5 - 21	Load Drum	5 - 23
Surface Number	5 - 21	Delete Drum	5 - 23
Dynamic Curve	5 - 22	Other	5 - 23
Position Curve	5 - 22	Info	5 - 23
		Surface Menu	5 - 24
Drum Head Menu	5 - 22	Pitch	5 - 24
Info on SDX	5 - 22	Brightness	5 - 24
Info on Drums	5 - 22	Resonance	5 - 24
Info on Drum Heads	5 - 22	Noise	5 - 24
Info on Drum Surfaces	5 - 22	Level	5 - 24
Info on Drum Curves	5 - 22	Pan	5 - 24
Control Panel	5 - 22	Length	5 - 24
		SampleStart	5 - 24
Memory Menu	5 - 22	Next Menu	5 - 24
Save Drum	5 - 22	Drum Sample Assign	5 - 24
Save Drum As	5 - 22	Drum Head	5 - 24
New Drum	5 - 22	Quit	5 - 24
Load Drum	5 - 22		
Delete Drum	5 - 23		
Info	5 - 23		

Section 5.6

REFERENCE : SAMPLER SCREEN

Screen Parameters	5 - 25	Sampler Menu	5 - 27
Sample Name	5 - 25	Info on SDX	5 - 27
Rate	5 - 25	Info on the Sampler	5 - 27
Peak Meter	5 - 25	Info on Looping	5 - 27
Threshold Adjust	5 - 25	Info on Truncating	5 - 27
Sample Window	5 - 26	Control Panel	5 - 27
View Bars	5 - 26		
Loop Pointers	5 - 26	Memory Menu	5 - 27
Edit Pointers	5 - 26	Rename Sample	5 - 27
Zoom Window	5 - 26	Save Sample Truncated	5 - 27
Preview	5 - 26	New Sample	5 - 27
Sample	5 - 26	Edit Sample	5 - 27
Start Point	5 - 26	Delete Sample	5 - 27
End Point	5 - 26	Info	5 - 27
Sample Protection	5 - 26		
Marker Select	5 - 27		

Disk Menu	5 - 28	Utility Menu	5 - 29
Save Sample	5 - 28	Sine	5 - 29
Save Sample As	5 - 28	Hi-Ramp	5 - 29
Save Sample Truncated	5 - 28	Lo-Ramp	5 - 29
Edit Sample	5 - 28		
Delete Sample	5 - 28	Next Menu	5 - 29
Other	5 - 28	Quit	5 - 29
Info	5 - 28		
 Special Menu	 5 - 29		
Loop Options	5 - 29		
Clear Samples not in Window	5 - 29		
Reverse Samples in Window	5 - 29		
Maximise Sample Amplitude	5 - 29		
Protection	5 - 29		

Section 6

XSEQ : PERCUSSION SEQUENCER

Future Upgrade

Section 7

XEDIT : SAMPLE EDITOR

Future Upgrade

Section 8

INTERFACES

MIDI	8 - 1
SCSI	8 - 3
SMPTE	8 - 5

Section 9

SOUND DISKS

Sound Disk #1	9 - 1	Sound Disk #4	9 - 7
Sound Disk #2	9 - 3	Sound Disk #5	9 - 9
Sound Disk #3	9 - 5	Sound Disk #6	9 - 11

APPENDIX

MIDI Implementation	10 - 1
Specification	10 - 3
Electrical	10 - 3
Inputs	10 - 3
Outputs	10 - 3
Processor Boards	10 - 4
Floppy Disk Drive	10 - 5
Hard Disk/SCSI Port	10 - 5
Tracker Ball	10 - 5
Credits	10 - 7

Introducing SDX

CONTENTS

SDX Concept	1 - 1
Packing List	1 - 3
SDX 10 Piece Kit	1 - 3
SDX 7 Piece Kit	1 - 4
SDX 5 Piece Kit	1 - 5
SDX Console Only	1 - 6
Optional	1 - 6
Before You Start	1 - 7
Important	1 - 7
Connecting to the Mains	1 - 7
Changing the Fuse	1 - 7
Looking After SDX	1 - 8

Introducing SDX

CONTENTS

SDX Concept	1 - 1
Packing List	1 - 3
SDX 10 Piece Kit	1 - 3
SDX 7 Piece Kit	1 - 4
SDX 5 Piece Kit	1 - 5
SDX Console Only	1 - 6
Optional	1 - 6
Before You Start	1 - 7
Important	1 - 7
Connecting to the Mains	1 - 7
Changing the Fuse	1 - 7
Looking After SDX	1 - 8

SDX

It cannot be denied that electronic instruments are playing an increasing role in drums. Electronic Percussion, Samplers, Drum Machines, Reverbs and Delays are all expanding the sonic palette of the percussive artist.

Yet some aspects of the instrument have been overlooked in this revolution. The subtle tonal change between the centre and edge of a drum head, or the depth of expression available by varying the weight of each stroke.

Simmons have applied the latest advances in electronics, to produce an instrument that offers the modern drummer an unprecedented level of player control and expression.

SDX, the definitive electronic percussion system.

- Zone Intelligent Pads
- 16 Full-Bandwidth Voices
- 16 bit Sampling at 44.1KHz, CD standard Digital Audio.
- Up to 8 MegaBytes of Memory
- 2 MegaByte High Density Integral Disk Drive
- 20 MegaByte Internal Hard Disk option
- Integral VDU and user - friendly command interface
- Software upgradeable

GRAPHIC OPERATION

A number of simple displays, known as Screens, present all of SDX's powerful features in a simple, graphic manner. Pull-down Menus and Windows allow you to move between Screens or select Functions quickly and easily, using only the Tracker Ball and Select button. You can load a complete Kit, construct a Drum Head, or even edit a Sample in the same intuitive manner.

ZONE INTELLIGENT PADS

To complement the electronics a new series of Drum and Symbal pads have been created for SDX. High technology, force-sensing materials give the pads their unique **Zone Intelligent** capabilities. These not only allow the strike position to be determined, but allow a degree of sensitivity and dynamic control never previously associated with electronic drums.

All Drums, apart from the Bass, are Zone Intelligent. The Snare pad has the addition of a live rim and the Symbal pads even incorporate a damping and tilting mechanism. Key pads on the front panel of the Console are also fully dynamic and can be used instead of the Kit pads.

DRUM SAMPLES

Each Drum or Symbal sound can comprise of up to 9 Samples. A Sample is selected by the position and weight of the hit on a pad. Hence, as you would expect from an acoustic drum, the tonal characteristics of the sound can be made to change across the drum head as well as varying with the strike Dynamic.

DRUM HEADS

Another innovative area of SDX is the way in which Samples can be modified in real-time, responding to the action of the sticks on the pads. A **Drum Head** defines how each Sample is played and can be constructed from a number of **Surfaces**. Each Surface determines the way in which one particular aspect of the sound changes in time, relative to the weight and position of each stroke.

For instance, there is a Surface for Pitch bend that allows more in the centre, less at the edge. Another which stretches the sound for hard strokes, and shortens it for lighter strokes. There is a Surface which varies the Start Point of the Sample for each stroke, negating the 'machine gun effect' associated with electronic drums.

THE FUTURE

SDX is a stand-alone computer and therefore does not require to be hooked up to personal computers to run other software packages. It has a full compliment of interfaces. MIDI, for communication with other musical instruments. SCSI, for access to additional bulk data storage. SMPTE, for synchronising with Video and Audio equipment.

Being a computer, SDX's Operating System is supplied on Disk. As new updates and enhancements become available, they can be added immediately simply by using an updated System Disk.







CONCLUSION

High quality Digital Audio, controlled by traditional drumming techniques. The power to create unique new Drums and Symbals using an intuitive graphic interface. The flexibility to expand and evolve a system. The definitive system ... **SDX**.

PACKING LIST

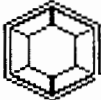
After unpacking your SDX, check that you have all the components listed, according to your system configuration :

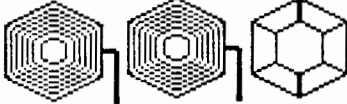
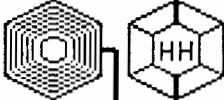
SDX 10 PIECE KIT

	1	SDX Console (2 Meg RAM)	
	1	Mains Lead	
	1	Double Footswitch	
	1	SDX User Manual	
	1	SDX System Disk	
	1	SDX Backup Disk	
	1	SDX Help Disk	
	6	SDX Sound Disks	
	1	SDX Blank Disk	
	1	Bass Pad	
	1	Z1 Snare Pad	
	5	Z1 Tom Pads	
	3	SPS Symbal Pads	
	1	Hi-Hat Pedal	XHH1
	10	Z1 Pad Cable (Stereo Jack to Jack) SJC1	
	1	Z1 Snare Cable (XLR to Twin Jack) XTC1	
	6	Velstrap	
			
			
			

Optional Rack

1	Simmons Drum Rack	SDR1b
2	Drum Rack Extension	DRE1
2	Simmons Tom Arm	STA1
1	Arm Mount Clamp	AMC1

SDX 7 PIECE KIT

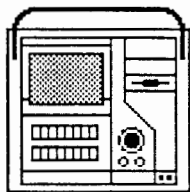

- 1 SDX Console (2 Meg RAM)
- 1 Mains Lead
- 1 Double Footswitch
- 1 User Manual
- 1 SDX System Disk
- 1 SDX Backup Disk
- 1 SDX Help Disk
- 6 SDX Sound Disks
- 1 SDX Blank Disk



- 1 Bass Pad
- 1 ZI Snare Pad

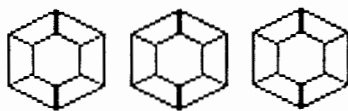

- 4 ZI Tom Pads
- 1 SPS Symbal Pad
- 1 Hi-Hat Pedal

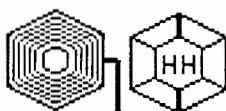

- 7 ZI Pad Cable (Stereo Jack to Jack) SJC1
- 1 ZI Snare Cable (XLR to Twin Jack) XTC1
- 6 Velstrap

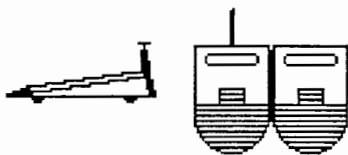

Optional Rack

- | | | |
|---|---------------------|-------|
| 1 | Simmons Drum Rack | SDR1b |
| 1 | Drum Rack Extension | DRE1 |
| 1 | Simmons Tom Arm | STA1 |

SDX 5 PIECE KIT

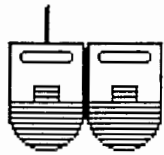
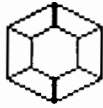
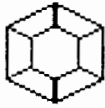
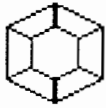
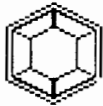

- 1 SDX Console (2 Meg RAM)
- 1 Mains Lead
- 1 Double Footswitch
- 1 SDX User Manual
- 1 SDX System Disk
- 1 SDX Backup Disk
- 1 SDX Help Disk
- 6 SDX Sound Disks
- 1 SDX Blank Disk

- 1 Bass Pad
- 1 Z1 Share Pad
- 3 Z1 Tom Pads

- 4 Z1 Pad Cable (Stereo Jack to Jack) SJC1
- 1 Z1 Share Cable (XLR to Twin Jack) XTC1
- 6 Velstrap

Optional Rack

- 1 Simmons Drum Rack SDR1b

SDX CONSOLE ONLY

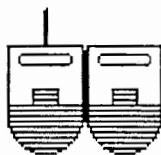

- 1 SDX Console (2 Meg RAM)
- 1 Mains Lead
- 1 Double Footswitch

- 1 SDX User Manual
- 1 SDX System Disk
- 1 SDX Backup Disk
- 1 SDX Help Disk
- 6 SDX Sound Disks
- 1 SDX Blank Disk

OPTIONAL

Since the SDX Console has 16 Pad Inputs you can add additional ZI Toms and Symbols to extend your 10, 7 or 5 Piece Kits.

ZI Tom Pad & Lead	ZIP1
SPS Symbal Pad & Lead	ZIS1
ZI Snare Pad & Lead	ZSN1
Hi-Hat Pedal & Lead	XHH1
SDX Console Stand	XCS1
Drum Rack Extension	DRE1
Simmons Tom Arm	STA1
Arm Mount Clamp	AMC1
Memory Upgrade (2MByte)	XRAM2
Factory Fit Hard Disk Drive	HDR20
SDX Percussion Sequencer Package	XSEQ
SDX Sample Editor Package	XEDIT

IMPORTANT



Before you do anything check that the Voltage Selector, located on the base of the Console, matches your local mains supply. The selection can be adjusted by turning the slot, with a small screwdriver, until the raised dot lines up with the required setting.

Select 240 for UK, Europe and Australia (180 - 260V)
Select 120 for USA, Canada and Japan (90 - 130V)

WARNING: This Instrument uses a Switched Mode Power Supply and therefore must be Earthed.

CONNECTING TO THE MAINS

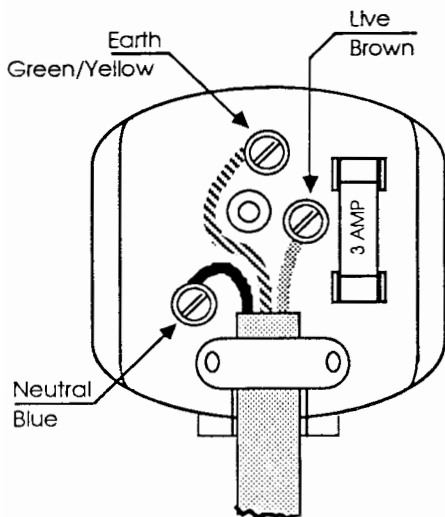

European Mains voltages

Connect an appropriate mains plug to the mains cable according to the following colour code.

- Brown - Live
- Blue - Neutral
- Green/Yellow - Earth (Ground)

CHANGING THE FUSE

The Fuse is located in a holder under the Mains Switch, next to the IEC connector. To remove, disconnect the mains lead and use a small screwdriver to release the fuseholder.

If you have to replace the fuse for any reason, make sure that you replace it with the correct rating, according to the following Voltage settings.

240V - 2.5A (T) Anti-Surge
220V - 2.5A (T) Anti-Surge
115V - 5A (T) Anti-Surge
100V - 5A (T) Anti-Surge

LOOKING AFTER SDX

SDX is a computer-based instrument and as such should be treated with care. A few simple rules, if followed, will avoid problems in the future.

- Try and use a clean power source, away from equipment that may produce transient spikes through the mains, i.e. electric motors, heavy switch gear etc. These are unsympathetic to electronic music products.
- SDX is supplied with a three core power lead. Make sure that the instrument is always Earthed, by connecting to a grounded AC power source.
- Do not place the SDX Console on top of speaker cabinets or amplifiers which might subject it to excessive vibration or heat.
- Do not spill any liquids into the Disk Drive, Tracker Ball or Control Buttons.
- Do not subject the SDX Console to sudden shocks, such as dropping it!
- SDX's Z Drum Pads and SPS Symbal Pads have been exhaustively tested to provide you with the most advanced electronic percussion surfaces yet invented.

However, like Drum skins and guitar strings, they are not indestructible and will not last forever.

Replacement or Additional Drum and Symbal pads can be purchased from an authorised Simmons Dealer.

SDX is fitted with an internal Shock Sensor to indicate if the Console has been subjected to abnormal shocks.

If the sensor indicates that the Console has been dropped the unit's Warranty will be invalid.

<p>Note: There are no User - Serviceable parts inside. Warranty will be invalidated if the Console is opened.</p>

Setting Up

CONTENTS

Assembling The Kit 2 - 1

Assembling a 10 Piece Kit	2 - 1
Assembling a 7 Piece Kit	2 - 4
Assembling a 5 Piece Kit	2 - 7
Console Stand Assembly	2 - 9

Connecting Up 2 - 11

SDX 10 Piece Kit	2 - 11
SDX 7 Piece Kit	2 - 12
SDX 5 Piece Kit	2 - 13
Pad Inputs	2 - 14
Voice Outputs	2 - 14
Sampler In / Snare & Stereo Out	2 - 15
Pedals	2 - 15
MIDI	2 - 15
SMPTE	2 - 16
SCSI	2 - 16
Video Out	2 - 16

Amplification 2 - 17

Amplification	2 - 17
SDC200	2 - 17
Mixers	2 - 17
Headphones	2 - 18

SDX Pads can be mounted for live playing using the **Simmons Drum Rack (SDR1b)** and **Drum Rack Extensions (DRE1)**. These combine to form a modular system, allowing many assembly alternatives. After the initial assembly, **Memory-Locks** make future construction and dismantling quick and easy, requiring only the use of a standard drum key.

The following descriptions are a guide to setting-up your SDX Kit in a conventional position. This configuration should allow you attain a playing position you feel comfortable with. However, you may wish to experiment with novel and unusual ways of setting up which would normally be impossible with acoustic drums.

Additional, or replacement, rack components can be purchased separately from your Simmons dealer, see the Packing List for the relevant part number.

ASSEMBLING A 10 PIECE KIT

Step 1

Identify all the Rack items supplied with your Kit :

- 3 Crossbars
- 4 Upright Poles
- 4 Base Poles fitted with T-Joints
- 2 Bass Drum Poles (7/8" Diameter)
- 6 T-Joints
- 11 Tom Brackets
- 6 Tom Arms
- 2 Canvas Bags
- 1 Drum Key

Step 2

Study the diagram showing the assembled Kit.

Step 3

Insert the unplugged end of an **Upright Pole** fully into the **T-joint** already mounted on a **Base Pole**. Ensure the rubber stabilisers are facing towards the floor when the Upright is vertical. Lock this section using the Drum Key. Construct 3 similar units using the remaining Upright and Base Poles.

Step 4

Fit the necessary **Tom Brackets** and **T-Joints** onto the **Crossbars** and **Upright Poles**, slackening all tension bolts beforehand. Do not lock these brackets into position or insert **Tom Arms** yet.

- 1 **Tom Bracket**, then 1 **T-Joint** onto each of the front **Uprights**.
- 1 **T-Joint** onto each of the rear **Uprights**.
- 4 **Tom Brackets** onto the front **Crossbar**.
- 2 **Tom Brackets** onto the **Crossbar** on your left-hand.
- 3 **Tom Brackets** onto the **Crossbar** on your right-hand.

Step 5

Assemble the **Uprights**, **Crossbars** and **Base Poles** to form a free-standing structure, gently tightening the **T-Joint** bolts as you do so. The front Crossbar should be approx 6" below the tops of the front Uprights, allowing the right and left hand Crossbars to be fitted. Ensure that the Uprights are vertical and the Crossbars horizontal, before fully tightening the T-Joints.

- Note : **Crossbars** have a slot, or keyway, at each end. It is important that these are correctly located into the **T-joints** and pushed fully home, before locking. This eliminates any possibility of the Crossbar rotating when the Pads are mounted.

Step 6

Push the 2 **Bass Drum Poles** through the **Tom Brackets** on the front **Uprights**. These should be approx 15" from the floor. Hold the **Bass Drum** Pad in position and push the Bass Drum Poles through the holes in the side of the Pad. Gently half-tighten the Locks on the Tom Brackets and Bass Drum Pad.

Step 7

Fit your **Bass Drum Pedal** and adjust the height of the Pad until the pedal base is flush with the floor when the Pad is vertical. Once you have checked that the **Bass Drum Poles** are horizontal, tighten the Locks on the **Tom Brackets** and **Bass Drum** Pad.

Step 8

Choose positions for **ZI Drum**, **Hi-Hat** and **Symbal** Pads and half-tighten the 9 **Tom Brackets** on the **Crossbars**. Insert the 6 **Tom Arms** and lock these in position by tightening the Tom Brackets.

Step 9

Slide the **ZI Snare** Pad onto it's **Tom Arm** and lock into position using the **Memory Lock**. The **Snare** is different from the other Pads, having a **Live Rim**. You can identify the Snare by the 4 pin XLR socket used to connect it to the Console. All the other **ZI Tom** Pads are identical and can be used in any Pad position.

Step 10

Slide the **ZI Tom** Pads and **ZI Hi-Hat** Pad onto the other **Tom Arms** and adjust into a suitable playing position. Once adjusted, lock them using the **Memory Locks**. The **Hi-Hat Pedal** should be positioned under the Hi-Hat Pad in a position which feels natural when seated.

Step 11

ZI Symbal Pads have their own support arms which should be inserted into the remaining **Tom Brackets**. These Pads should be adjusted to lie at approx 45 degrees, allowing them to swing between vertical and horizontal when struck. To vary the amount of swing, adjust the **Lock** on the Pad. To vary the rest position, slacken the bolt on the end of the support arm, rotate the Pad, then re-tighten.

If you don't want the Pad to swing, there is an internal **Swing Lock** which will fix it in one position. Release the Lock on the Pad so it is free to swing. From its rest position, push the Pad into the support arm and slowly turn it clockwise. After about a quarter of a turn it will click towards the support arm. Continue turning for a further quarter turn and pull the Pad away from the support. This will lock it in place. To release the Pad reverse the above operation.

- Note : Each **SPS Symbol** has a **Choke Area**, under the 'SIMMONS' and 'SYMBAL' legends, which will damp the sound when gripped. Make sure that this is with easy reach, mounting the support arm on the left or right of the pad.

Step 12

Once the Pads have been connected to the Console, use the Velstraps to hold the leads neatly against the Rack Poles.

Assembled 10 Piece Kit

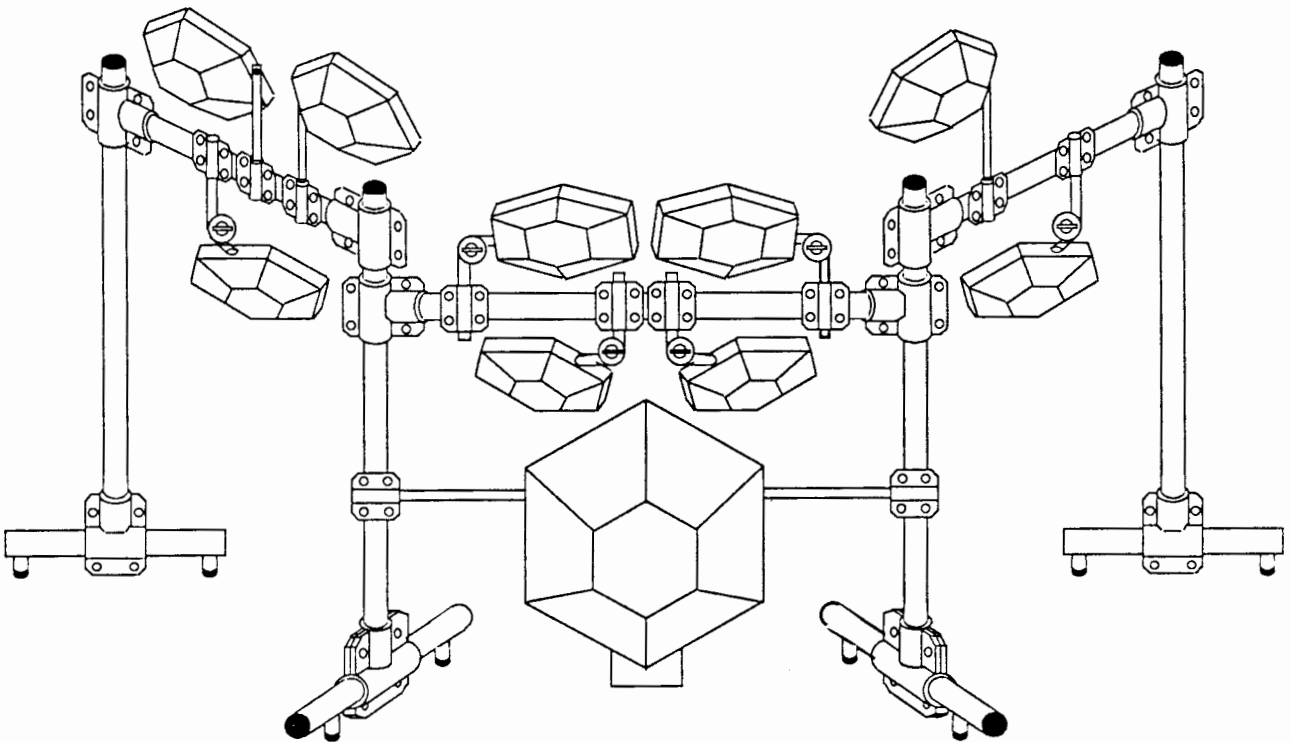

Warning : Slacken Tension Bolts before attempting to alter any Pad or Clamp positions.

ASSEMBLING A 7 PIECE KIT

Step 1

Identify all the Rack items supplied with your Kit :

- 2 Crossbars
- 3 Upright Poles
- 3 Base Poles fitted with T-Joints
- 2 Bass Drum Poles (7/8" Diameter)
- 4 T-Joints
- 8 Tom Brackets
- 5 Tom Arms
- 1 Canvas Bag
- 1 Drum Key

Step 2

Study the diagram showing the assembled Kit.

Step 3

Insert the unplugged end of an **Upright Pole** fully into the **T-joint** already mounted on a **Base Pole**. Ensure the rubber stabilisers are facing towards the floor when the Upright is vertical. Lock this section using the Drum Key. Construct 2 similar units using the remaining Upright and Base Poles.

Step 4

Fit the necessary **Tom Brackets** and **T-Joints** onto the **Crossbars** and **Upright Poles**, slackening all tension bolts beforehand. Do not lock these brackets into position or insert **Tom Arms** yet.

- 1 **Tom Bracket**, then 1 **T-Joint** onto each of the front **Uprights**.
- 1 **T-Joint** onto the rear **Upright**.
- 4 **Tom Brackets** onto the front **Crossbar**.
- 2 **Tom Brackets** onto the **Crossbar** on your left-hand.

Step 5

Assemble the **Uprights**, **Crossbars** and **Base Poles** to form a free-standing structure, gently tightening the **T-Joint** bolts as you do so. The front Crossbar should be approx 6" below the tops of the front Uprights, allowing the left hand Crossbar to be fitted. Ensure that the Uprights are vertical and the Crossbars horizontal, before fully tightening the T-Joints.

- Note : **Crossbars** have a slot, or keyway, at each end. It is important that these are correctly located into the **T-joints** and pushed fully home, before locking. This eliminates any possibility of the Crossbar rotating when the Pads are mounted.

Step 6

Push the 2 **Bass Drum Poles** through the **Tom Brackets** on the front **Uprights**. These should be approx 15" from the floor. Hold the **Bass Drum Pad** in position and push the **Bass Drum Poles** through the holes in the side of the Pad. Gently half-tighten the **Locks** on the **Tom Brackets** and **Bass Drum Pad**.

Step 7

Fit your **Bass Drum Pedal** and adjust the height of the Pad until the pedal base is flush with the floor when the Pad is vertical. Once you have checked that the **Bass Drum Poles** are horizontal, tighten the **Locks** on the **Tom Brackets** and **Bass Drum Pad**.

Step 8

Choose positions for **ZI Drum**, **Hi-Hat** and **Symbal Pads** and half-tighten the 6 **Tom Brackets** on the **Crossbars**. Insert the 5 **Tom Arms** and lock these in position by tightening the **Tom Brackets**.

Step 9

Slide the **ZI Snare Pad** onto it's **Tom Arm** and lock into position using the **Memory Lock**. The **Snare** is different from the other Pads, having a **Live Rim**. You can identify the Snare by the 4 pin XLR socket used to connect it to the Console. All the other **ZI Tom Pads** are identical and can be used in any Pad position.

Step 10

Slide the **ZI Tom Pads** and **ZI Hi-Hat Pad** onto the other **Tom Arms** and adjust into a suitable playing position. Once adjusted, lock them using the **Memory Locks**. The **Hi-Hat Pedal** should be positioned under the **Hi-Hat Pad** in a position which feels natural when seated.

Step 11

ZI Symbal Pad has it's own support arm which should be inserted into the remaining **Tom Bracket**. This Pad should be adjusted to lie at approx 45 degrees, allowing it to swing between vertical and horizontal when struck. To vary the amount of swing, adjust the **Lock** on the Pad. To vary the rest position, slacken the bolt on the end of the support arm, rotate the Pad, then re-tighten.

● If you don't want the Pad to swing, there is an internal **Swing Lock** which will fix it in one position. Release the Lock on the Pad so it is free to swing. From its rest position, push the Pad into the support arm and slowly turn it clockwise. After about a quarter of a turn it will click towards the support arm. Continue turning for a further quarter turn and pull the Pad away from the support. This will lock it in place. To release the Pad reverse the above operation.

● Note : The **ZI Symbal** has a **Choke Area**, under the 'SIMMONS' and 'SYMBAL' legends, which will damp the sound when gripped. Make sure that this is within easy reach, mounting the pad on the left or right of the pad.

Creative Use of SDX

Step 12

Once the Pads have been connected to the Console, use the Velstraps to hold the leads neatly against the Rack Poles.

Assembled 7 Piece Kit

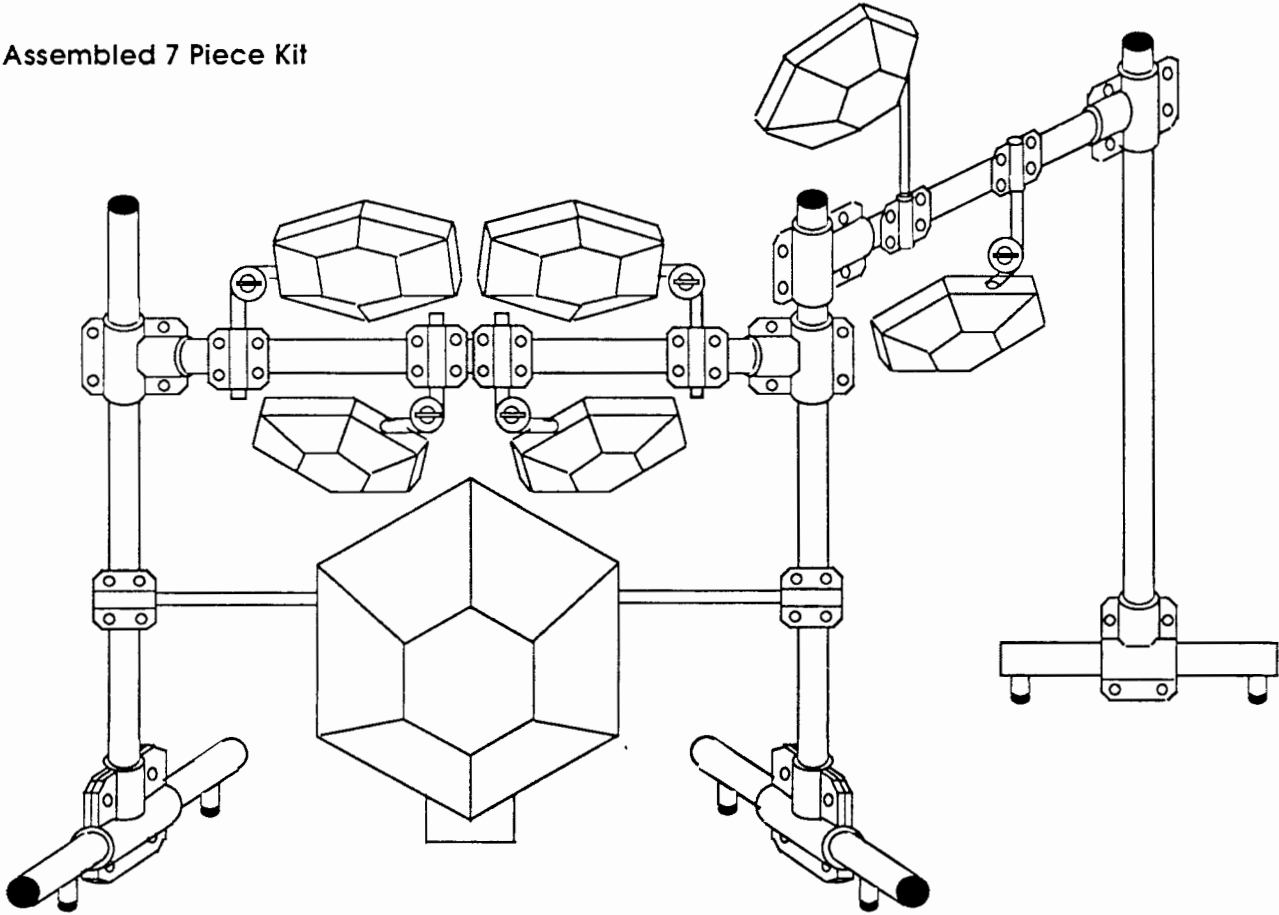

Warning : Slacken Tension Bolts before attempting to alter any Pad or Clamp positions.

ASSEMBLING A 5 PIECE KIT

Step 1

Identify all the Rack items supplied with your Kit :

- 1 Crossbar
- 2 Upright Poles
- 2 Base Poles fitted with T-Joints
- 2 Bass Drum Poles (7/8" Diameter)
- 2 T-Joints
- 6 Tom Brackets
- 4 Tom Arms
- 1 Canvas Bags
- 1 Drum Key

Step 2

Study the diagram showing the assembled Kit.

Step 3

Insert the unplugged end of an **Upright Pole** fully into the **T-joint** already mounted on a **Base Pole**. Ensure the rubber stabilisers are facing towards the floor when the Upright is vertical. Lock this section using the Drum Key. Construct a similar unit using the remaining Upright and Base Pole.

Step 4

Fit the necessary **Tom Brackets** and **T-Joints** onto the **Crossbar** and **Upright Poles**, slackening all tension bolts beforehand. Do not lock these brackets into position or insert **Tom Arms** yet.

- 1 **Tom Bracket**, then 1 **T-Joint** onto each of the front **Uprights**.
- 4 **Tom Brackets** onto the front **Crossbar**.

Step 5

Assemble the **Uprights**, **Crossbar** and **Base Poles** to form a free-standing structure, gently tightening the **T-Joint** bolts as you do so. The front Crossbar should be approx 6" below the tops of the front Uprights, allowing future extensions to be fitted. Ensure that the Uprights are vertical and the Crossbars horizontal, before fully tightening the T-Joints.

- Note : The **Crossbar** has a slot, or keyway, at each end. It is important that it is correctly located into the **T-joints** and pushed fully home, before locking. This eliminates any possibility of the Crossbar rotating when the Pads are mounted.

Step 6

Push the 2 **Bass Drum Poles** through the **Tom Brackets** on the front **Uprights**. These should be approx 15" from the floor. Hold the **Bass Drum Pad** in position and push the Bass Drum Poles through the holes in the side of the Pad. Gently half-tighten the Locks on the Tom Brackets and Bass Drum Pad.

Step 7

Fit your **Bass Drum Pedal** and adjust the height of the Pad until the pedal base is flush with the floor when the Pad is vertical. Once you have checked that the **Bass Drum Poles** are horizontal, tighten the Locks on the **Tom Brackets** and **Bass Drum Pad**.

Step 8

Choose positions for the **ZI Drum Pads** and half-tighten the 4 **Tom Brackets** on the **Crossbar**. Insert the 4 **Tom Arms** and lock these in position by tightening the Tom Brackets.

Step 9

Slide the **ZI Snare Pad** onto it's **Tom Arm** and lock into position using the **Memory Lock**. The **Snare** is different from the other Pads, having a **Live Rim**. You can identify the Snare by the 4 pin XLR socket used to connect it to the Console. All the other **ZI Tom Pads** are identical and can be used in any Pad position.

Assembled 5 Piece Kit

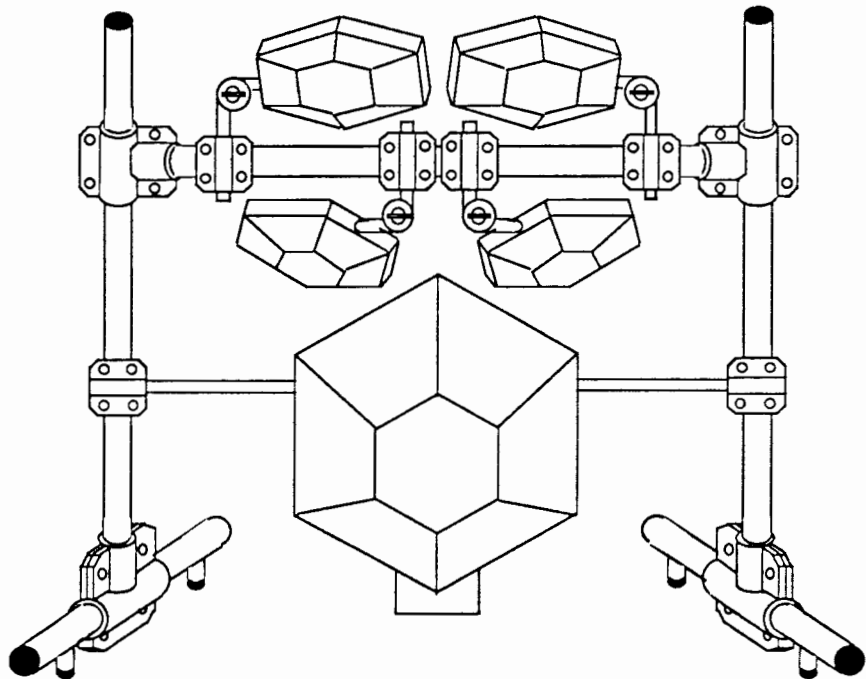

Step 10

Slide the **ZI Tom** Pads onto the other **Tom Arms** and adjust into a suitable playing position. Once adjusted, lock them using the **Memory Locks**.

Step 11

Once the Pads have been connected to the Console, use the Velstraps to hold the leads neatly against the Rack Poles.

Warning : Slacken Tension Bolts before attempting to alter any Pad or Clamp positions.

CONSOLE STAND ASSEMBLY

A Stand is available as an option for the SDX Console. This allows the Console to be situated next to the Kit at the correct height for seated operation. The Stand is on wheels, allowing it to be moved around easily, but can be locked in place for live use.

Step 1

Identify all the items supplied with the Stand :

- 1 Base Plate
- 1 Kick Plate
- 1 Left Hand Support
- 1 Right Hand Support
- 2 Locking Wheels
- 2 Adjustable Feet
- 4 Locknuts
- 12 Hex Headed Bolts - Long
- 12 Plastic Washers
- 12 Black Plastic Caps
- 4 Tension Bolts - Short
- 4 Metal Washers
- 1 Hex Key
- 1 Flat Spanner

Step 2

Fit each of the 12 Hex-headed Bolts with a plastic washer, making sure that the text on the washer is next to the Bolt head.

Step 3

Fix the Left Hand Support to the Base Plate using 4 of these Bolts. The SDX logo should be facing you when you insert the Bolts. Half-tighten the Bolts using the Hex Key.

Step 4

Fix the Right Hand Support to the Base Plate using another 4 Bolts. The SDX logo should be facing you when you insert the Bolts. Half-tighten using the Hex Key.

Step 5

Fix the Kick Plate to the Supports using the remaining 4 Bolts. The SDX logo should be to the front when you insert the Bolts. Half-tighten using the Hex Key.

Step 6

Make sure that the Stand is square, not twisted, then fully tighten the 12 Bolts using the Hex Key.

Step 7

Fit each of the 2 Adjustable Feet and the 2 Locking Wheels with a Locknut. Tighten the Locknut until it is next to the Foot or Wheel.

Step 8

Turn the Stand on it's side and screw the 2 Adjustable Feet into the holes at the front of the Side Supports, then screw the 2 Locking Wheels into the holes at the back of the Side Supports.

Step 9

Turn the Stand upright again and adjust the Feet and Wheels, using the flat spanner, so that all 4 are touching the ground, ensuring that the Stand doesn't rock. Once you have done this tighten the Locknuts against the Supports to lock the Feet and Wheels in place.

Step 10

To complete the Stand, clip the 12 Black Plastic Caps over the Hex-headed Bolts onto the plastic washers.

Step 11

Place the SDX Console on top of the stand and fix in place using the 4 Tension Bolts, fitted with washers, which screw up into the Console surround. Tighten fully using a Drum Key.

The Console can now be moved around by tilting the Stand slightly onto its back wheels and moving it with the aid of the Console Roll Bar as a handle.

To lock the Stand in place push the plastic tab on the back Wheels downwards. Pull upwards to release.

Keep the Hex Key and Flat Spanner in a safe place, in case you need to dismantle the Stand for shipping.

SDX 10 PIECE KIT

Once you have assembled your 10 Piece hardware, connect the Zi Drum, Symbal and Hi-Hat Pads to the Console's Pad Inputs and Stereo Out to your Amplifier, or Mixer, as shown below:

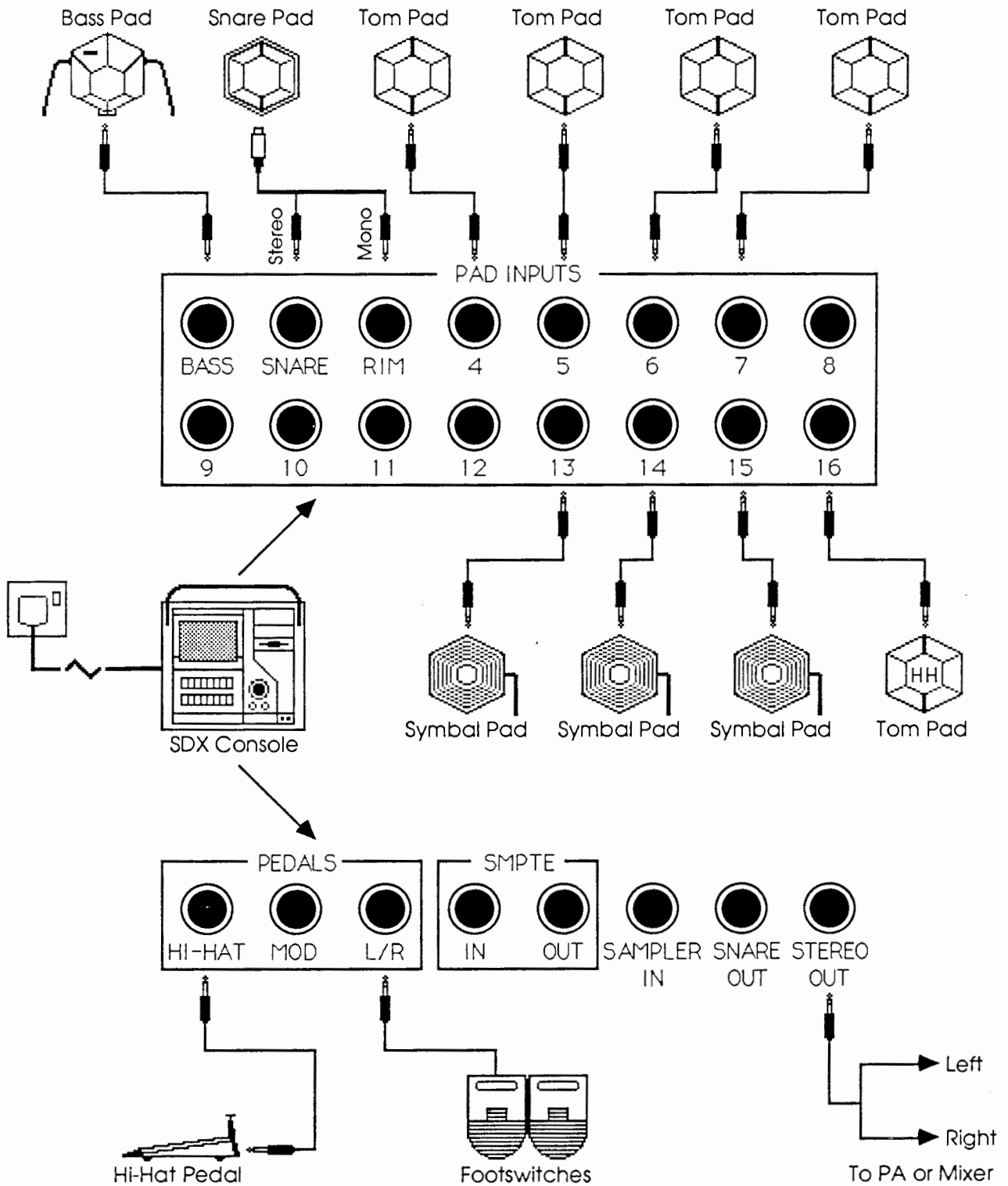

Creative Use of SDX

SDX 7 PIECE KIT

Once you have assembled your 7 Piece hardware, connect the Zi Drum, Symbal and Hi-Hat Pads to the Console's Pad Inputs and Stereo Out to your Amplifier, or Mixer, as shown below:

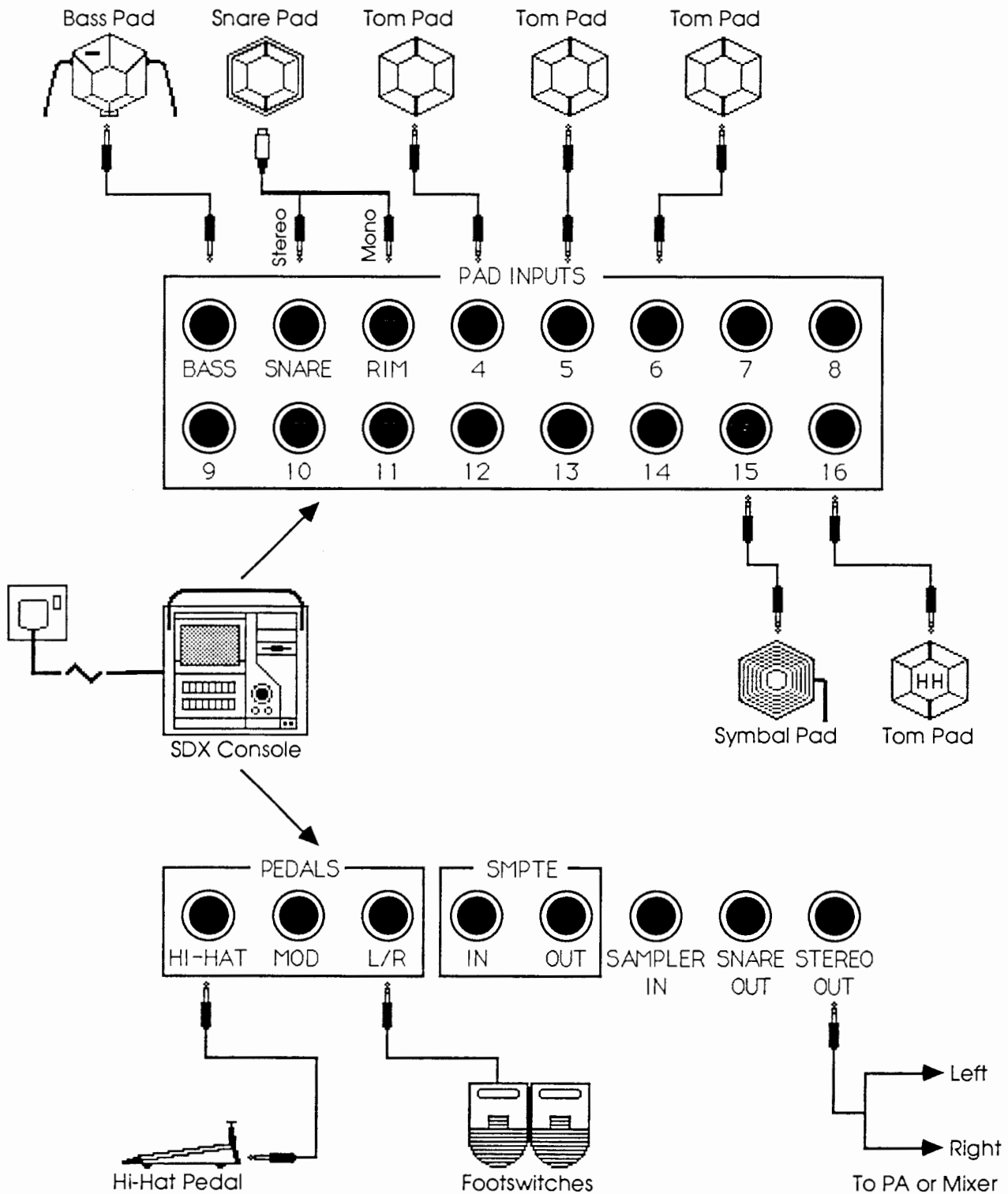

SDX 5 PIECE KIT

Once you have assembled your 5 Piece hardware, connect the Bass Drum, Z1 Tom and Z1 Snare Pads to the Console's Pad Inputs and Stereo Out to your Amplifier, or Mixer, as shown below:

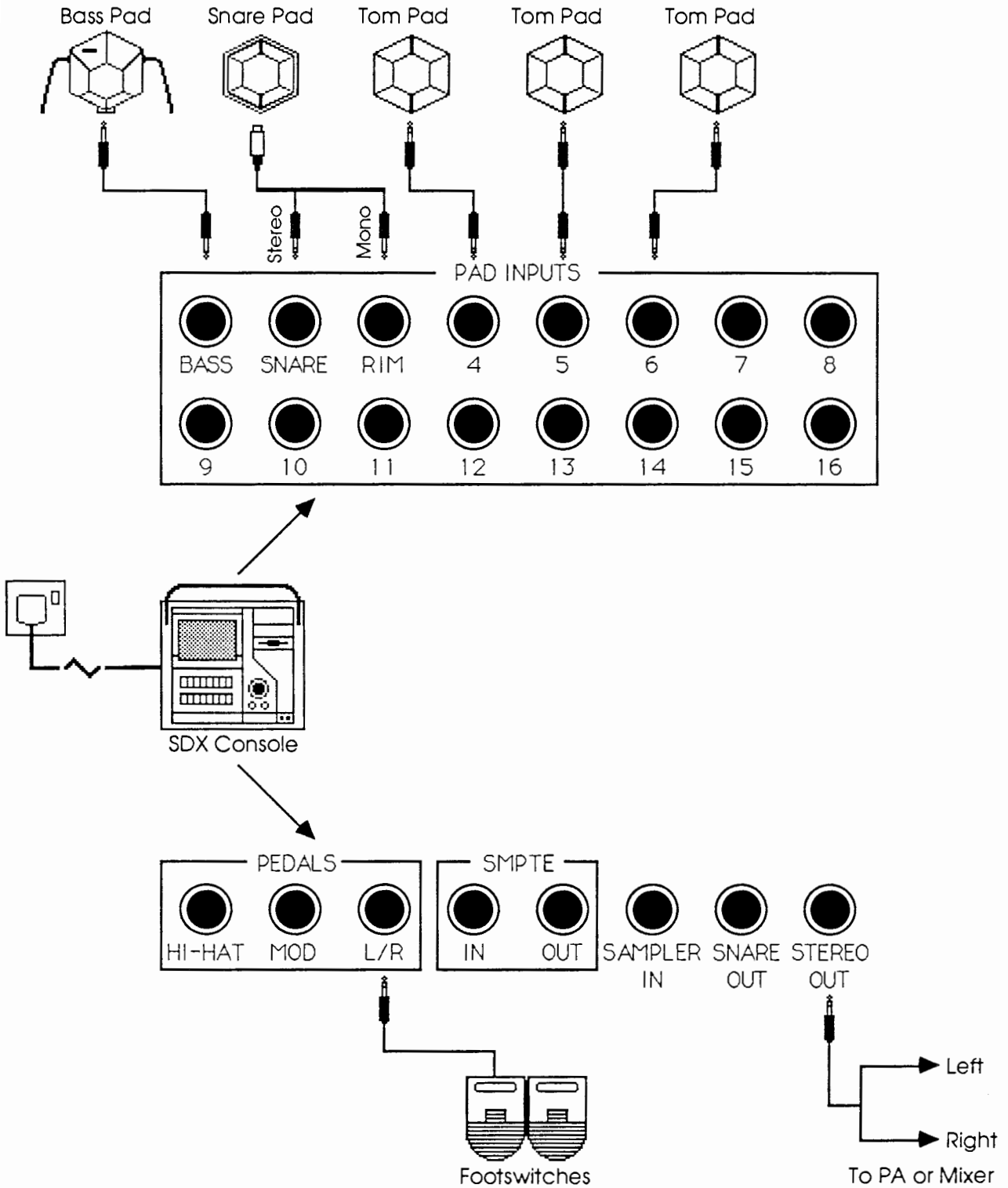

Creative Use of SDX

All the connectors, which SDX uses to interface with the rest of the world, are situated on the rear of the Console. They are listed here with a brief description of their function.

PAD INPUTS

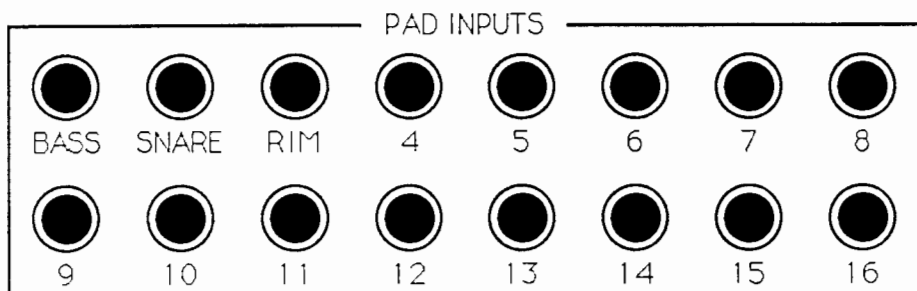

The first three input sockets are defined. These should be connected to the Bass and Snare pads as follows :

Bass Pad	(Mono)	to	Bass Input	(Mono)
ZI Snare Pad	(4 pin XLR)	to	Snare Input	(Stereo)
			and Rim Input	(Mono)

The other 13 Inputs are identical and can be connected to ZI Pads and SPS Symbols in any order.

ZI Tom Pad	(Stereo)	to	ZI Pad Input	(Stereo)
SPS Symbol Pad	(Stereo)	to	ZI Pad Input	(Stereo)

VOICE OUTPUTS

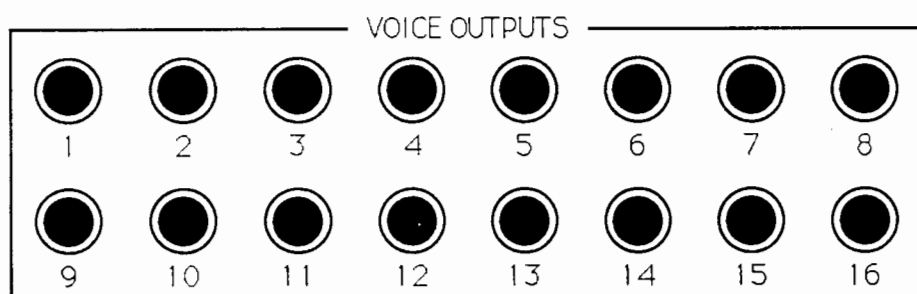

Each of the sixteen Voices has its own individual output socket allowing you to post-process individual Drums, and connect them to a Mixing Desk.

You can use the Stereo Out on stage for your own monitoring and adjust your the mix level from the Kit Mixer Screen. This will not effect the Individual Voice Outputs.

SAMPLER IN / SNARE & STEREO OUT



Sample In

This input accepts signals at Line level which can be Digitally Sampled and stored in Memory or on Disk.

Snare 2,3,4

This output is a sub-mix of Voices 2, 3 and 4 which are used by the Snare Pad, when the default Voice Assignment is selected on the Kit Configuration Screen.

Stereo Out

If you have only a limited number of channels available on your desk or amplifier then use this output, situated above the individual Voice Outs. The Kit Mixer Screen allows you to Mix and Pan all of the 16 individual voices to this output.

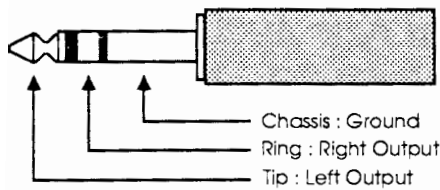

Chassis	-	Ground
Ring	-	Right
Tip	-	Left

PEDALS

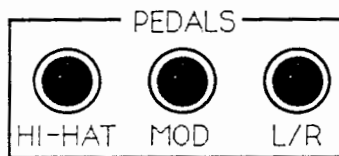

Hi-Hat Pedal

The Hi-Hat Pedal (7 & 10 kits only) should be connected to this input. This allows the assigned Hi-Hat pad to be played open, closed or in a 'sizzle' position. The Pedal can also trigger its own Sample.

L/R Pedal

The dual footswitch (Left/Right) should be connected to this input to allow Kits to be selected remotely from the floor.

MIDI

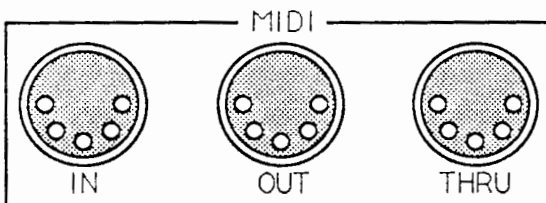

MIDI IN

An external MIDI source such as a MIDI Keyboard or Sequencer can be used to play Drum Samples in chromatic intervals and change Kits using Program changes.

MIDI OUT

External MIDI Keyboards or Voice Expanders can be played from the Z1 pads allowing other sounds to be layered on top of SDX.

MIDI THRU

Thru is a copy of the signal received at MIDI In and allows other instruments to receive the same information when chained together.

SMPTE

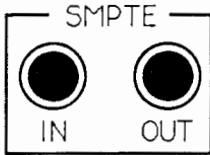

SMPTE IN/OUT

SMPTE is a timecode signal, mainly used in the video world, which defines hours, minutes, seconds and frames within a 24 hour period. This interface can be used to synchronize the SDX Percussion Sequencer to other SMPTE equipment, by starting or stopping it at a specific frame of code. Sound events can be sampled into SDX and 'dropped in' to a video or film production within one frame.

SCSI

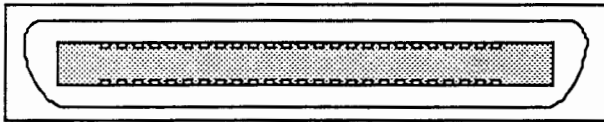

SCSI

SCSI

SCSI stands for Small Computer Systems Interface. This allows SDX to have external Hard disks to be connected. These are large storage mediums which allow a vast number of Kits, Drums and Samples to be stored and rapidly recalled. SDX can have one 20Mb Hard Disk fitted internally. External hard disks must have their own Power Supply.

VIDEO OUT



Video Out

Video Out is provided to allow an external Video Monitor to be used in addition to the SDX screen. This can be used to duplicate the current SDX activities in the Studio Control room.

AMPLIFICATION

Obviously the size of the venue and type of music being played will effect your choice of Amplification. However, drum sounds are highly percussive, especially those produced by SDX. Therefore, your chosen system should be capable of reproducing very dynamic sounds, spanning the ear's frequency range from 20 to 20,000 Hz.

SDC200

For smaller venues Simmons have designed their own combination amplifier, the SDC200, which will match the signals coming from SDX. It is a 200W Amplifier and Speaker enclosure with separate inputs for Bass, Snare Tom Toms and Symbals, with appropriate 2 and 3 band equalisation to suit the different drums.

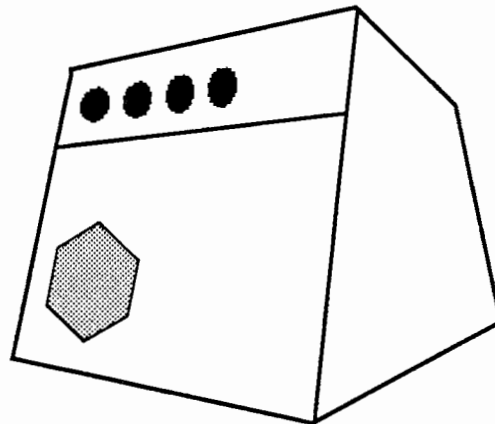

The SDC200 has a specially designed 300W RMS 12" speaker to project the high level of bass and handle the fast transients produced by electronic percussion. The Amplifier/Speaker Cabinet combination has been optimised to give you maximum sound level from this compact unit. Ask your dealer for further information.

MIXERS

When SDX is used live and you wish to utilise the facilities of an external mixing desk, each of the Voice Outputs from 1-16 should be connected to a separate channel of the desk. Each channel will then control only the sound from the relevant Voice, provided that each Pad has been assigned to only one Voice (Using the **Kit Configuration Screen**). This allows each Drum sound to be equalised or treated independently. If vacant channels are in short supply, the Stereo Out should be used. Using the Stereo Out allows Multi-Voice Drums to be used. These provide much more accurate simulations of real Drums.

HEADPHONES

The Headphone socket found on the front of the console will accept any standard 1/4" stereo jack and enables you to monitor SDX's Stereo Out without any external amplification. High-impedance headphones, such as those found on 'Walkmans' are recommended. Ideally use headphones designed for Digital or CD reproduction. Note that the control next to the Headphone socket allows the Volume to be adjusted from maximum when fully clockwise, to minimum when fully anticlockwise, but will not turn the output completely off.

Getting Started

CONTENTS

Introducing Disks	3 - 1
Disk Drive	3 - 1
Disk Etiquette	3 - 1
Disk Protection	3 - 2
Power Up	3 - 3
Power-Up	3 - 3
Optional Hard Disk	3 - 3
Kit Select Screen	3 - 5
System Kit	3 - 5
User Controls	3 - 6
Tracker Ball	3 - 6
Select Buttons	3 - 6
Pull Down Menus	3 - 6
Windows	3 - 8
Help System Window	3 - 8
Key Pads	3 - 8
L/R Pedals	3 - 8
Loading A Kit	3 - 9
Loading Kits from Sound Disks	3 - 9
Load All Kits	3 - 10
Loading from a Hard Disk	3 - 10
Disk Versus Memory	3 - 11
Disk Versus Memory	3 - 11
Internal Memory Options	3 - 11
Internal Hard Disk Drive	3 - 11
Memory Information	3 - 12
Disk Information	3 - 13

DISK DRIVE



First remove the yellow plastic disk from the **Disk Drive**, by pushing the rectangular button. This **Transport Disk** is used to protect the Drive during transportation and should be inserted whenever you move the SDX console.

The Disk Drive is used to load the **System Disk**, which contains the operating system for SDX. Of the 10 disks supplied, 2 of these are System Disks. They are identical, one should be your **Master** disk, the other a **Backup**. Since SDX will not operate without one of these disks they must be treated with great care. In the event of the Master being lost or damaged, contact your Simmons Dealer for a replacement, using the Backup copy in the meantime.

The other 6 disks are **Sound Disks**. These hold a library of Digital Samples, Drums and Kits, produced by some of the world's greatest drummers and producers. Once you are familiar with the operation of SDX you will be able to save your own Samples, Drums and Kits, creating a unique digital percussion library.

DISK ETIQUETTE

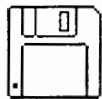

Although the microfloppy Disks used in SDX are quite tough, they should still be handled with care. To preserve the life of your precious System and Sound Disks please follow the following rules:

- Do not subject them to temperature extremes, such as being in direct sunlight, or leaving them on the seat of your car.
- Do not place them near magnetic fields such as those produced by Speaker Cabinets, Power Amplifiers or telephones.
- When a Disk is placed into the Drive the metal covering on the Disk case slides open so that SDX can get data to and from the Disk. Never touch the exposed Disk surface under the metal covering.
- Do not use adhesive tape to attach paper labels to the Disk casing. Always use the adhesive labels provided with Blank Disks.

DISK PROTECTION

Protected



Information can be Read from or Written to a Disk just as music is Played from or Recorded to a Cassette Tape. Therefore you would expect some method of protecting a Disk from accidental erasure or adding unwanted information as you would a Tape.

Turn a Disk over so that the label side is facing downwards, metal shutter towards you. In the top left hand corner you will see a small plastic tab. To **Protect** the Disk slide the plastic tab upwards, towards the edge.

Protecting the Disk allows you to Read information, so you can Load Kits, Drums or Samples, but you will not be able Save, Delete or Rename anything.

To remove the Protection simply slide the plastic tab towards the metal shutter.

Your System Disks should **always** be protected.

Never try and remove a Disk while the Drive is active. This may damage both Drive and Disk.

POWER-UP

Turn down the Volume on your Amplifier or Mixer, then power-up the SDX console by flicking the mains switch on the rear panel to ON. After allowing a few seconds for the VDU Screen to warm up you should be presented with the following Welcome message :

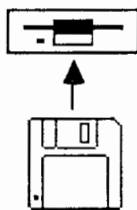
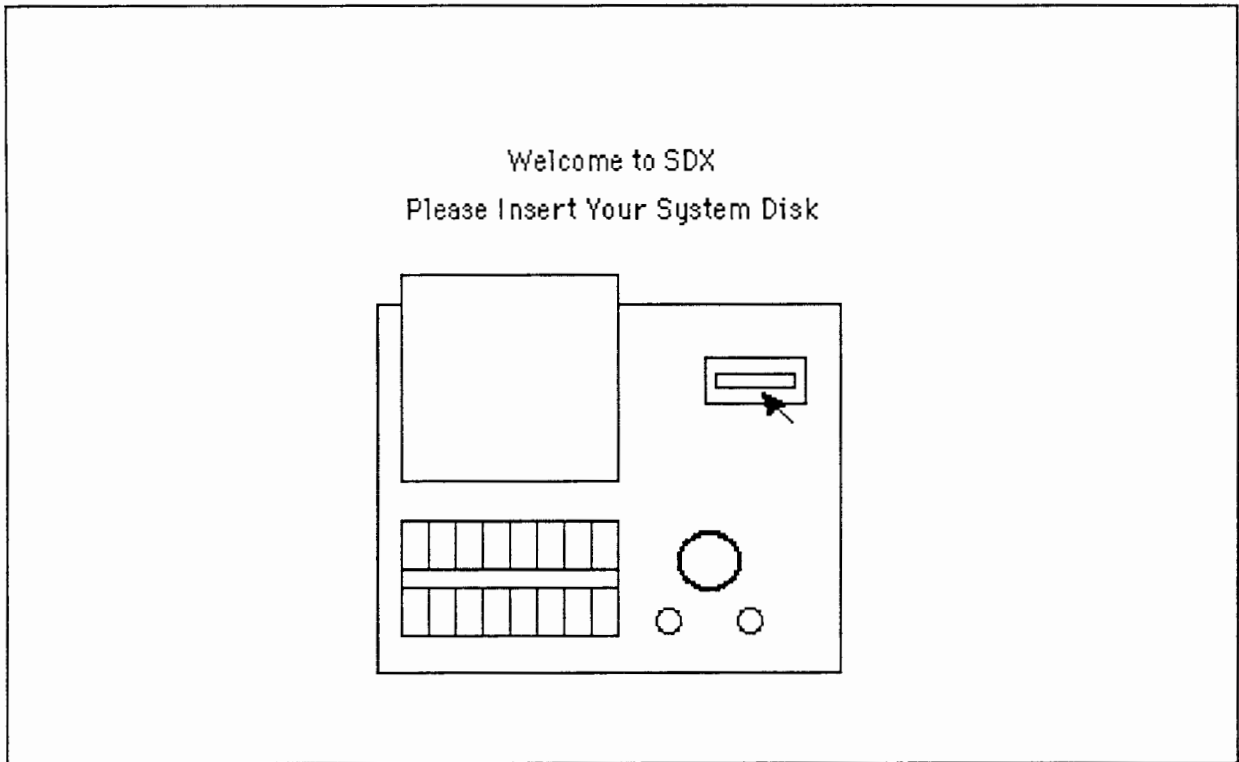

Remove the **System Disk** from the Disk sleeve in the back of this Manual and insert it into the Drive. Push the Disk, label side up, metal shutter first into the horizontal slot in the Drive until the rectangular release button pops out.

The yellow indicator next to the release button will now light, indicating that the Drive is active and that SDX is reading the operating system into its memory.

Do not try and remove the Disk while the Drive is active.

Optional Hard Disk

If you have an internal Hard Disk fitted, you do not have to insert the System Disk. SDX will automatically load the System Software from the internal Drive. A red indicator, in the bottom left-hand corner of the Screen, will light indicating that the Hard Disk is active.

After a few seconds of Disk activity the following Screen will be displayed :

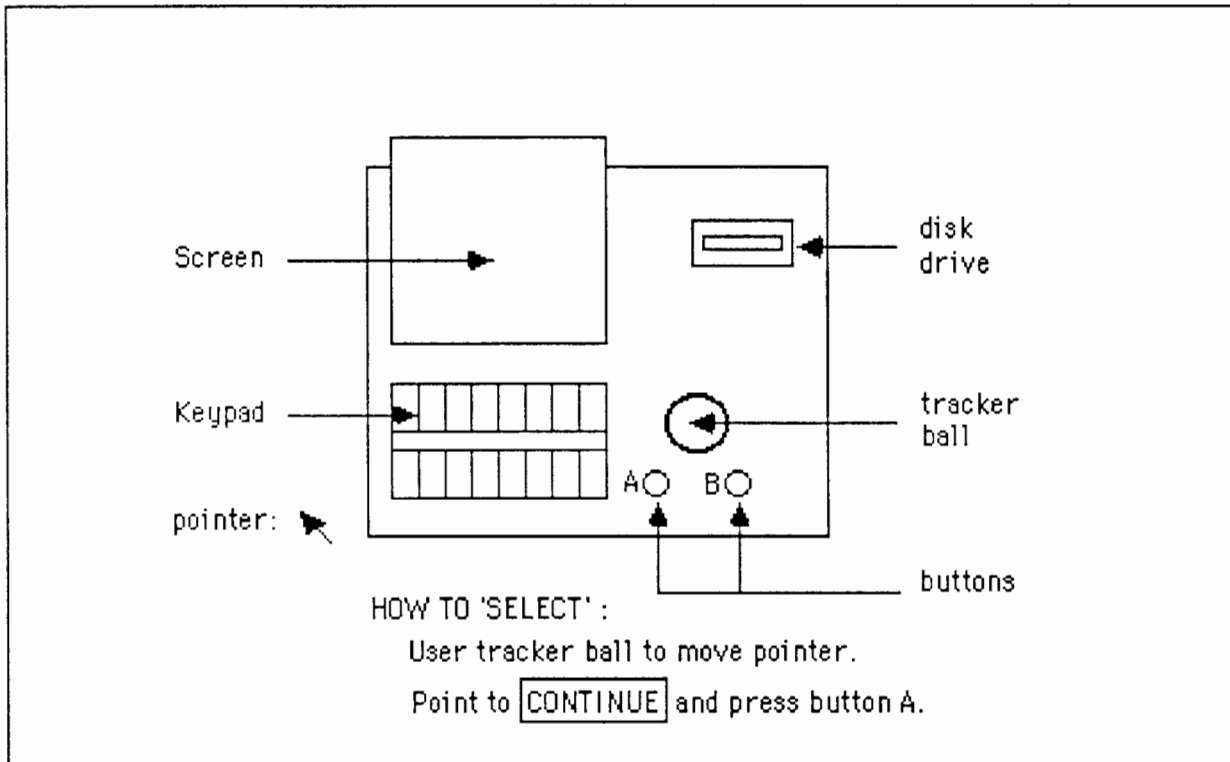

Using the **Tracker Ball**, move the **Pointer** until it is over the **CONTINUE** box then press the left hand **Select Button**.

Advanced users select: **CONTINUE**

First time users - insert a SIMMONS Sound disk.

DISK **HELP**

'select' disk box
and menu will appear,
keep button held down,
use tracker ball to
move pointer to choose option.
Release button.

SDX Software V1.1

Another Welcome Screen is displayed. These two Screens are provided to help First Time Users who do not have access to this User Manual.

Press the left hand **Select Button** again to display your first active SDX screen, the **Kit Select Screen**.

KIT SELECT SCREEN

A Screen is simply a Graphic Control Panel which guides you through the many functions of SDX. The **Kit Select Screen** allows you to load and select up to 16 different Kits from your Sound Disk library. You can transfer between this and the other Screens quickly and easily, getting deeper into SDX, but more of that later.

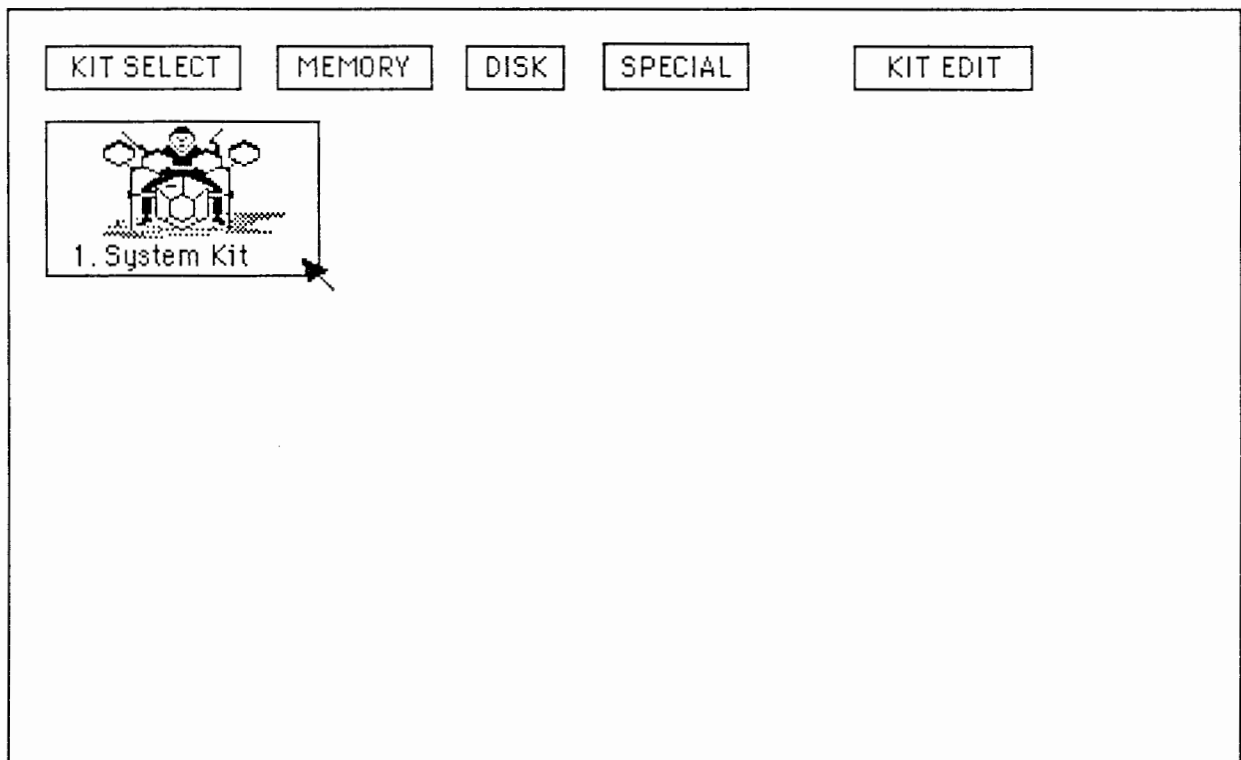

SYSTEM KIT



On the Screen you will see a picture, known as an **Icon**, representing a Drum Kit. Another icon, known as **Digit**, is sitting behind the Kit ! Under him is the name **System Kit**. This Kit is loaded when you first switch on.

TRACKER BALL



Your main interface to all SDX Screens is the **Tracker Ball**. Try moving the Tracker Ball in any direction. On the Screen a small arrow, called the **Pointer**, will follow every move you make. The Pointer lets you can move between Screens, select different Kits or Drums and even Edit Samples. Moving it with the Tracker Ball may feel a little awkward at first, but it will soon become second nature.

SELECT BUTTONS



Under the Tracker Ball are two large buttons. These are known as the **Select Buttons**. The left-hand button is always used to select the item you have pointed to with the Pointer arrow. The right hand button has several different functions, unique to each Screen. These will be explained in the relevant section.

PULL DOWN MENUS

Using the Tracker Ball, place the Pointer over the box named **Kit Select** then press and hold the left hand **Select Button**. Another box appears below with a list of choices in it. Each of these boxes along the top of the screen is called a **Pull Down Menu**.

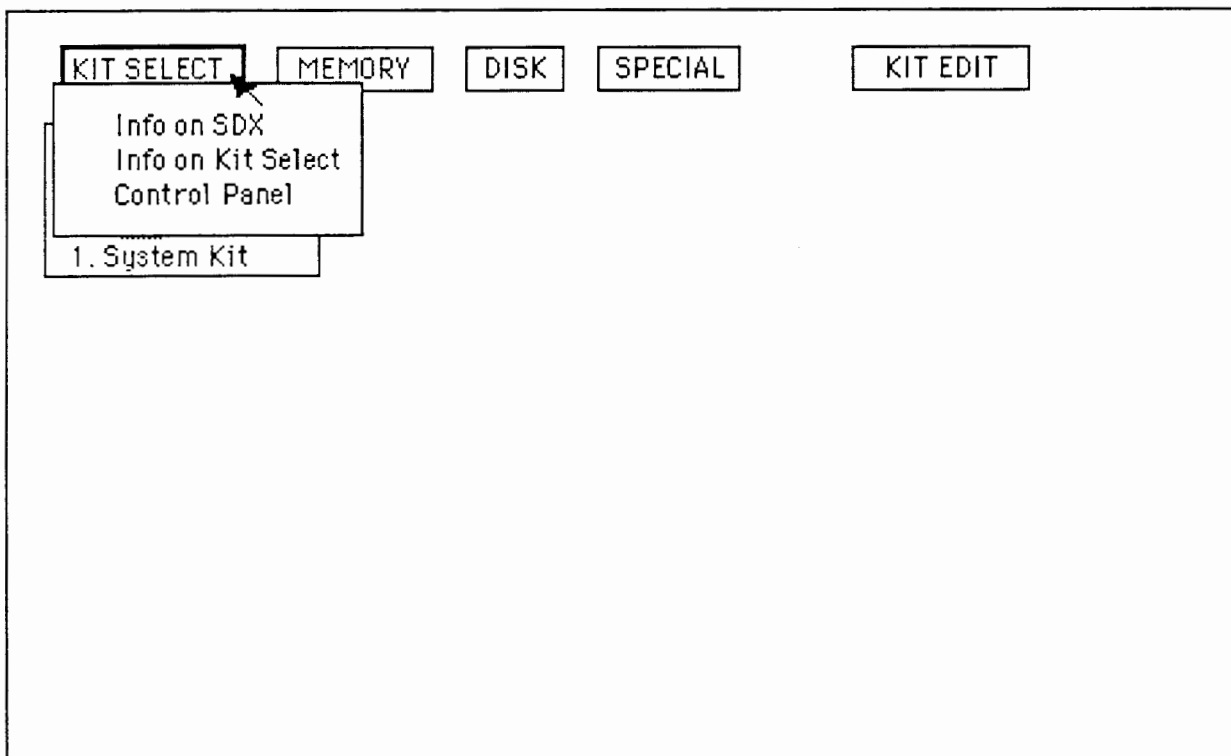

User Controls

Still holding the Select Button, roll the Tracker Ball downwards. The Pointer now changes to a horizontal arrow, pointing to each of the Menu Choices. Move the Tracker Ball until the arrow is pointing to **Info on SDX**.

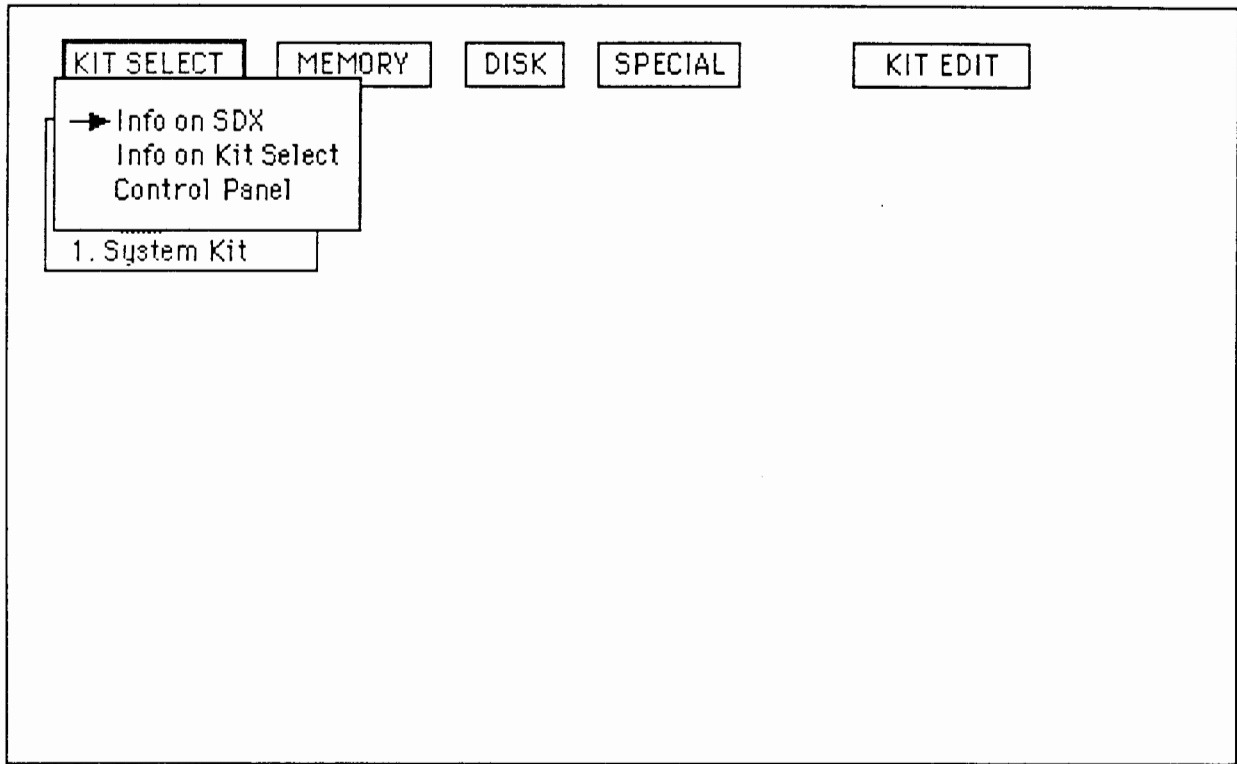

To select this choice from the Menu, release the Select Button. You have just selected **Info on SDX** from the **Kit Select Menu**. This provides you with a **Help System Window**.

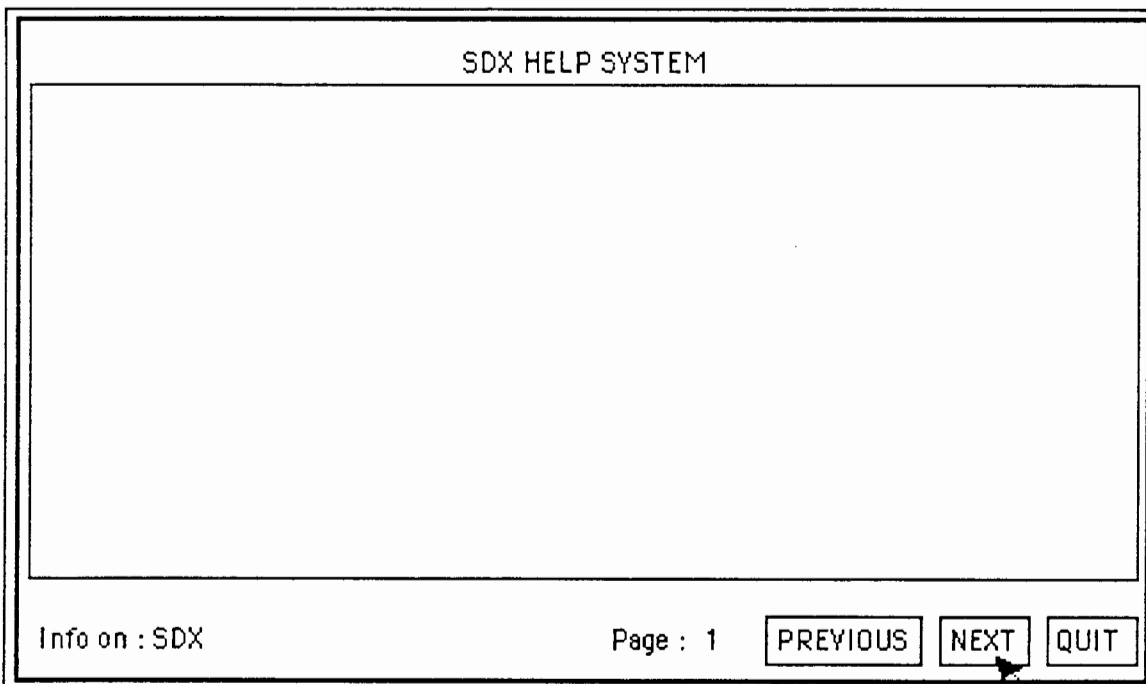

WINDOWS

A **Window** is a display box which is appears on top of the current Screen. Windows normally have **Click Boxes** which produce an action when the Pointer is placed on top of them and the Select Button clicked. The Help System Window has three boxes in the bottom right hand corner named **Previous**, **Next** and **Quit**. Insert your Help Disk, place the Pointer on **Next** and **Click** once. A page of Help text is displayed. Click **Next** again to display the next page of text. Now place the pointer over **Previous** and click once to display the previous page of text again. When you wish to leave the Help System Window place the Pointer over **Quit** and click.

HELP SYSTEM WINDOW

A Help System Window is available for every Screen on SDX. Once you have mastered the basics you can use these Windows as a guide, saving you from having to constantly refer to this User Manual, however, don't stop reading just yet !

All Help System Windows are available as choices from the current Screen's title box, situated in the top left hand corner. Place the Pointer over the box, hold the Select Button and roll the Ball downwards until the required **Info on ...** is indicated, then release the Select Button. Insert your Help Disk and Click **Next**. Click the **Quit** box to put the Window away.

KEY PADS

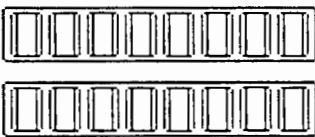

Under the VDU Screen are sixteen grey **Key Pads**, arranged in two rows of eight. These are fully dynamic and can be used in addition to, or instead of, the Kit Pads. The top row duplicates Pads 1-8, while the bottom row duplicates Pads 9-16. Using the **Control Panel** the function of these Pads can be changed, allowing them to be used to quickly select any one of the sixteen displayed Kits.

L/R PEDALS

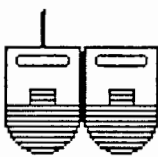

On the **Kit Select Screen** Kits can be remotely selected from the floor using the **L/R Pedal**.

Pressing the Right-hand Pedal increments the current Kit number, while the Left-hand Pedal decrements it.

LOADING KITS FROM SOUND DISKS

Once you have loaded the **System** you can remove the System Disk - you will not need it again unless the Console is powered down. However, this does not mean that you have gained a convenient beer mat ! Store the System Disk in the Disk Sleeve supplied with this Manual or in a suitable disk storage box.

Select one of the **Sound Disks**, making sure that it has been **Protected**.

Insert it into the drive, label side up, metal shutter first into the horizontal slot in the drive until the rectangular release button pops out.

Use the Tracker Ball to place the Pointer over the **DISK** box, then press and hold the Select button. The **Disk Menu** appears :

3-9 The Disk Menu now has a new option : **Clear Memory and Load All Kits**. This allows you to remove all the Kits, Drums and Samples currently in Memory and Load all of the Kits from the current Disk. Two Warning Windows will appear allowing you to cancel the option before the Memory is erased.

v 1.2

Roll the Tracker Ball downwards until the Horizontal arrow points to **Load Kit** and release the Select Button.

A **Load Catalog Window** appears on the Screen. This shows the Kits which can be selected from the Sound Disk you have just inserted.

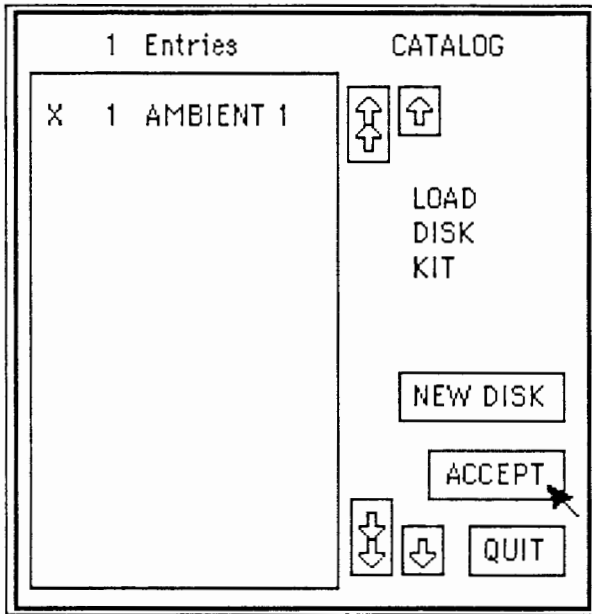

A **Special Menu** option - **Raw Sampling** allows you to transfer directly to the Sampler Screen without going through the normal route.

See Page 4 - 76 for a description of how to make new Samples. Also, see the notes 4 - 79 below, for a description of the new Sampler features.

The Sample you create can be played using Pad 1, the right-hand selection button or the Note icon.

Quitting from a Sampler Screen invoked by Raw Sampling will return you directly to the Kit Select Screen.

To select a Kit from the **Catalog** place the Pointer on the name of the Kit you want, then click the Select button. When the Select Button is released the Kit will be indicated by a cross. To Load this Kit move the Pointer to the **Accept** box and click.

A **Loading Kit ... Please Wait** message will appear and the Disk Drive will become active, clicking as the Kit information is loaded. This will take around 10 seconds depending on the complexity of the Kit.

Two Kits are now displayed on the Kit Select Screen. The one you have just loaded and the System Kit we started with. However, **Digit** has left his System Kit and appeared behind the new one. This indicates that the new Kit is **Active**.

Try playing the Kit you have just loaded, using the Kit or Key Pads.

To select the System Kit again, place the Pointer on it and click. **Digit** appears behind the System Kit again, indicating that it is now active.

Load All Kits

Instead of Loading Kits one at a time, you can Load all the Kits on one Sound Disk by selecting **Load All Kits** from the **Disk Menu**.

Loading from a Hard Disk

The Load Catalog shows all the Kits on the **Current Device**. If you started from the internal Hard Disk, it will be the Current Device. The Load Catalog will therefore display the Kits on one of the Drive's **Disk Slots**.

To Load Kits from the Floppy Drive you will have to make it the Current Device. See **Selecting the Current Device** in the **Disk Operations** Section.

DISK VERSUS MEMORY

You may be wondering why SDX has Memory and Disk Menus.

Floppy Disks are a convenient, portable medium on which to construct libraries of Kits, Drums and Samples, however, they have one major drawback - Speed. Loading a Kit can take some time and as the saying goes Time is Money.

Memory on the other hand is fast, allowing things to happen instantly, but volatile - when you switch off it forgets !

In order to give you the best of both worlds, SDX has an elephantine amount of Memory available, up to 8 MegaBytes, to contain all the Kits, Drums and Samples you are likely to need on a session as well as a High Density 2 MegaByte Disk Drive to load them.

This means that you can load from your Disk library once, after power-up, and continue working in Memory. New Kits can then be created either by re-arranging Drums and Samples supplied on Sound Disks or by Sampling your own sounds. When you are happy with your creation you can save your work back to the Floppy Disk Drive.

INTERNAL MEMORY OPTIONS

The basic SDX Console comes fitted with 2 MegaBytes of Memory. This equates to some two million, forty-eight thousand compartments of information in which to store details about Kits, Drums or Samples. Enough to store all the information from one Disk.

If you find yourself short of space you can increase SDX's Memory to 8 MegaBytes in 2 MegaByte stages (Order No. XRAM2). Ask your Simmons dealer about Memory options.

INTERNAL HARD DISK DRIVE

A Hard Disk drive can be fitted, as an option, inside the SDX Console (Order No. HDR20). This is a fixed disk and cannot be removed, but allows 20 MegaBytes of information to be stored and recalled. This drive is not only 10 times bigger than a floppy disk but is around 10 times faster. Therefore a Hard Disk is much more convenient for live performance use. Ask your Simmons dealer about Hard Disk options.

MEMORY INFORMATION

You can view the status of Memory at any time by selecting **Info** from the **Memory** menu. Point to the **MEMORY** box, press and hold the Select Button and roll the horizontal arrow to **Info**. Releasing the Select Button opens the **Memory Information Window**.

MEMORY INFORMATION			Free KBytes
Size : 8 Megabyte			Total : 06810
KITS : 2	DRUMS : 12	SAMPLES : 8	Size KBytes
AMBIENT 1 System Kit	AMB Bass	ambbass	134
	AMB Snare	ambtom2	131
	AMB Rim	brassn1	116
	AMB Tom 1	brassn3a	130
	AMB Tom 2	hi-hat cs	35
	AMB Tom 3	hi-hat o	117
	AMB Tom 4	nik 18"35b	217
	Hi-Hat	Sys Sample	8

Scroll

- **Size**
Shows the amount of Memory fitted in your SDX Console.
- **KITS**
Number and names of the Kits in Memory.
- **DRUMS**
Number and names of the Drums in Memory.
- **SAMPLES**
Number, names and sizes of the Samples in Memory.

Memory sizes are expressed in KBytes, or KiloBytes. One kilobyte equates to one thousand and twenty four compartments of information. There are one thousand KBytes in a MegaByte.

If there are more than 8 entries in any list, the others can be viewed by clicking the Up or Down **Scroll** arrows.

Click on the **Quit** box to close the Window.

DISK INFORMATION

You can also view the status of a Disk at any time by selecting **Info** from the **Disk** menu. Point to the **DISK** box, press and hold the Select Button and roll the horizontal arrow to **Info**. Releasing the Select Button opens the **Disk Information Window**.

DISK INFORMATION			Free KBytes
Device Name : floppy Disk Name : Simmons DSK			Total : 00400
Serial No : 1114F251 Size : 2 Megabyte			
Disk Type : User Library Prot :			
KITS : 1	DRUMS : 12	SAMPLES : 8	Size KBytes
AMBIENT 1	AMB Bass	ambbass	134
	AMB Snare	ambtom2	131
	AMB Rim	brassn1	116
	AMB Tom 1	brassn3a	130
	AMB Tom 2	hi-hat cs	35
	AMB Tom 3	hi-hat o	117
	AMB Tom 4	nik 18"35b	217
	Hi-Hat	Sys Sample	8
			<input type="button" value="↑"/> Scroll <input type="button" value="↓"/> <input type="button" value="NEW"/> <input type="button" value="QUIT"/>

- **Size**
1 or 2 MegaByte Disk.
- **KITS**
Number and names of the Kits on the Disk.
- **DRUMS**
Number and names of the Drums on the Disk.
- **SAMPLES**
Number, names and sizes of the Samples on the Disk.

If you want to see the contents of another Disk, remove the current Disk, replace it with the new one and Click **New**. The contents of the new disk will now be displayed.

If there are more than 8 entries in any list, the others can be viewed by clicking the Up or Down **Scroll** arrows.

Click on the **Quit** box to close the Window.

Creative Use of **SDX**

Section 4.1

Using SDX: Kit Mixer Screen

CONTENTS

Selecting the Kit Mixer Screen	4 - 1
Other 8	4 - 2
Adjusting Length	4 - 2
Adjusting Tune	4 - 2
Adjusting Pan	4 - 2
Adjusting Volume	4 - 3
Mute and Solo Switches	4 - 3
Muting a Channel	4 - 3
Soloing a Channel	4 - 3
Saving Changes	4 - 4
Save Kit	4 - 4
Save Kit As	4 - 4
Alphanumeric Keyboard	4 - 4
Loading other Kits	4 - 6
Loading Kits from Memory	4 - 6
Loading Kits from Disk	4 - 7
Special Mixer Functions	4 - 8
Initialise Mixer	4 - 8
Set All Mute/Solo Off	4 - 8
Set Pot & Slider Ranges	4 - 8
Leaving the Kit Mixer Screen	4 - 9
Save	4 - 9
Lose	4 - 9
Cont	4 - 9

Creative Use of SDX

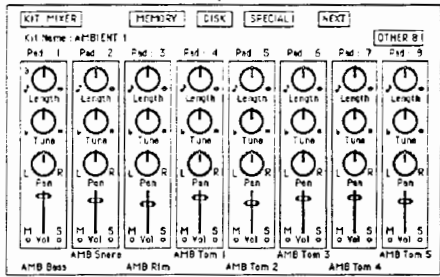
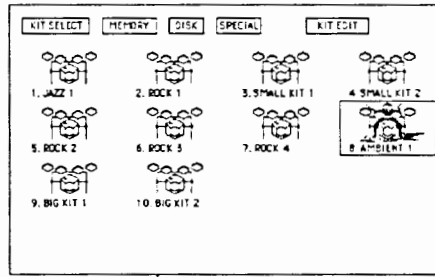

So far you should have used the **Kit Select Screen** to load Kits from your Sound Disks into Memory and then tried playing them using the Kit Pads.

SELECTING THE KIT MIXER SCREEN

You are now ready to get a little deeper into SDX. Point to the **KIT EDIT** box, then press and hold the Select Button. The **Kit Edit Menu** appears. Roll the Tracker Ball downwards to the first choice, **Kit Mixer**, then release the Select Button.

The **Kit Mixer** Screen is displayed. This is one level down from the Kit Select Screen, since we are now inside the **Active Kit**. You can see the Kit Name displayed at the top of the Screen.

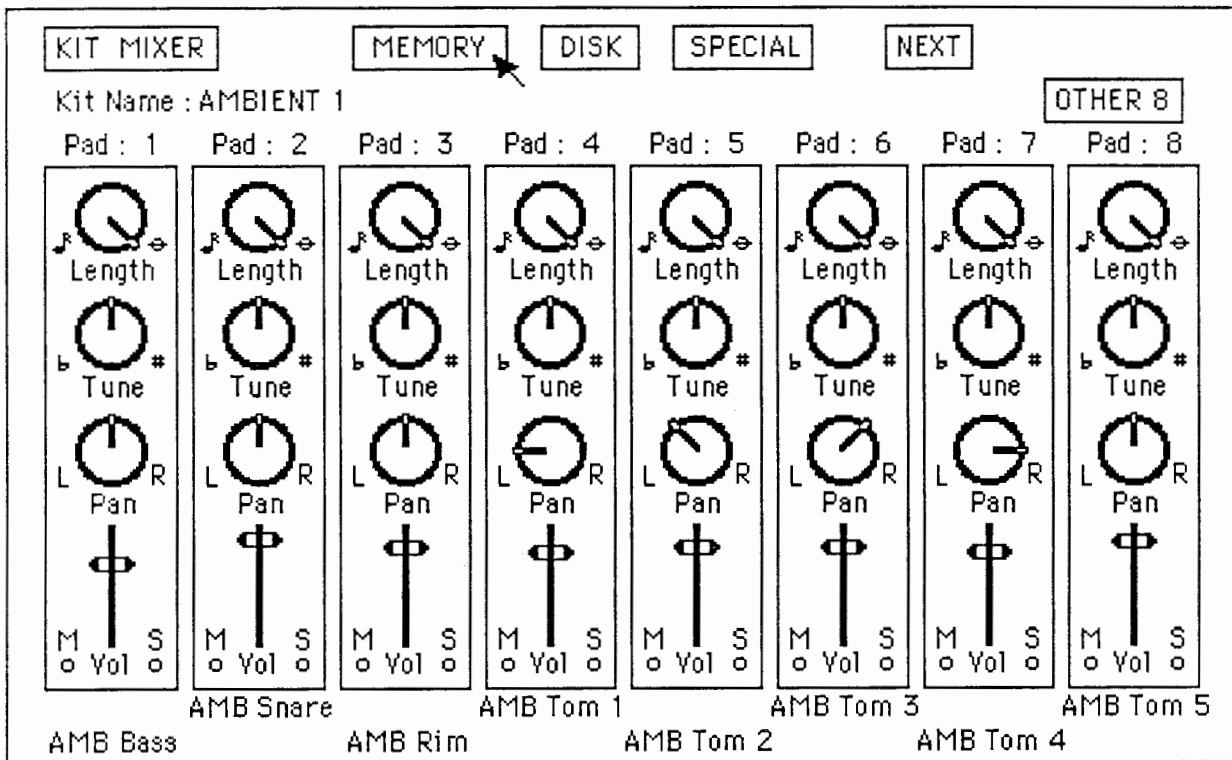

The Screen is laid out as a graphic representation of a conventional Mixer. There are eight channels which correspond to Pads 1 to 8, as indicated at the top of each channel, with the Active Drum Name shown at the bottom of the channel.

Four controls make up a channel :

- **Length**
Adjusts the Duration of the Drum Sound.
- **Tune**
Adjusts the Pitch of the Drum Sound.
- **Pan**
Adjusts the Drums Position in the Stereo image of the Mix Output.
- **Volume**
Adjusts the Level in the Mix Output.

OTHER 8

OTHER 8

Click on the **OTHER 8** box. The channel settings for Pads 9 to 16 are now displayed along with the Drum Names corresponding to these Pads. Click on the **OTHER 8** box again to alternate between the two sets of Pads. You can also alternate between the two sets of pads by clicking the right - hand Select Button.

ADJUSTING LENGTH



Point to the **Length** pot on the Snare (Pad 2) channel and hold the Select Button. The pointer will disappear, indicating that you now have control of the knob. Still holding the Select button, roll the Tracker Ball left to rotate the pointer of the knob left, decreasing the length of the Snare. Try playing the Snare with the new setting. Note that the controls operate in real-time so you can play while you adjust the panel. Select the pot again and roll the Tracker Ball right to rotate the pointer of the knob right, increasing the length of the Snare. Try playing the new setting.

You can initialise the pot, resetting it to maximum by **Double-Clicking** the Select Button. To do this place the Pointer on the knob and click the Select Button twice, quickly in succession.

ADJUSTING TUNE



Point to the **Tune** pot on the Snare (Pad 2) channel and while holding the Select Button, roll the Tracker Ball left to rotate the pointer of the knob left, decreasing the pitch the Snare. Rolling the Tracker Ball right rotates the pointer of the knob right, increasing the pitch of the Snare. Try playing different settings.

Double-Clicking the pot will initialise the Tune of the Pad to zero.

ADJUSTING PAN



Point to the **Pan** pot on the Snare (Pad 2) channel and while holding the Select Button, roll the Tracker Ball left to rotate the pointer of the knob left, moving the Snare left in the Stereo Mix. Rolling the Tracker Ball right rotates the pointer of the knob right, moving the Snare right in the Stereo Mix.

Double-Clicking the pot will initialise the Pan of the Pad to centre.

ADJUSTING VOLUME



Point to the **Volume** slider on the Snare (Pad 2) channel and while holding the Select Button, roll the Tracker Ball downwards to pull the slider down, decreasing the level of Snare in the Stereo Mix. Rolling the Tracker Ball upwards pushes the slider up, increasing the level of Snare in the Stereo Mix.

Double-Clicking the slider will initialise the Volume of the Pad to maximum.

As you can see the Kit Mixer operates just like a conventional mixer. Try adjusting the other channels, customising the Kit to your own taste.

MUTE AND SOLO SWITCHES

Muting A Channel

Under each Volume Slider you will see a small circle with the letter **M** above it. This is a Mute Switch. You can Mute any, or all, of the Channels by clicking on the relevant circle. When a circle is filled, the switch is on and the corresponding Drum Sound will drop out of the Stereo Mix. Note that Muted drums are still available from the Individual Voice Outputs, since Muting only effects the Stereo Mix. To switch off the Muting click on the filled circle. The circle will now be empty and the Drum Sound will appear again.

Soloing A Channel

On the other side of the Volume Slider is another small circle with the letter **S** above it. This is a Solo Switch. You can Solo any Channel by clicking on the relevant circle. When a circle is filled the switch is on and only the corresponding Drum Sound will be present in the Stereo Mix, all the other Drums will be muted. Note that the Muted drums are still available from the individual Voice Outputs, since Solo only effects the Stereo Mix. To turn off a Soloed Channel, click on the filled circle, returning the other drums into the Mix. When Solo is on you can Solo another Drum by clicking on its Solo Switch. This will cause the old Solo to be switched off and the new one switched on.

SAVING CHANGES AS A NEW KIT

After experimenting with the Mixer Screen you may find a combination of settings you wish to keep. You can either save your changes to Memory - remember that these will be lost when you power down - or save them to Disk.

Save Kit

Selecting **Save Kit** from the **Memory** menu will save any changes made to the Kit Mixer Screen as part of the active Kit in Memory, replacing the previous settings with current values. This will not effect the same Kit on your Disk. You should select **Save Kit** from the **Disk** menu if you wish to save any changes as part of the Kit on Disk.

Save Kit As

Selecting **Save Kit As** from the **Memory** menu will save any changes made to the Kit Mixer Screen as a new Kit in Memory, leaving the previous one as it was. Selecting **Save Kit As** from the **Disk** menu will save any changes as a new Kit on Disk. The Disk must be Unprotected.

When **Save Kit As** is chosen, an **Alphanumeric Keyboard Window** appears on screen allowing the new Kit to be named.

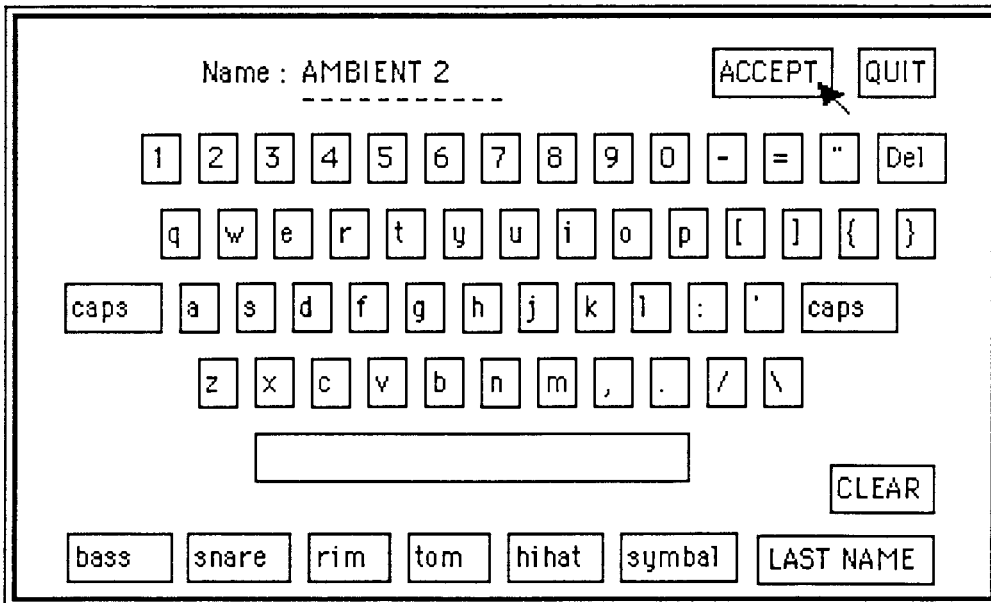

Alphanumeric Keyboard Window

To enter your new Kit name, using up to 11 characters, simply click on the letter or numbers in sequence. Click **Del** if you want to backspace or **Clear** to clear the entry. Common Drum names and the **Last Name** used are also available and are typed when clicked.

Upper case letters can be selected by clicking **Caps**. If you want to change your entry you can point to a character in the name and re-enter another letter or number.

Name : AMBIENT 2

ACCEPT QUIT

1 2 3 4 5 6 7 8 9 0 - = " Del

Q W E R T Y U I O P [] { }

CAPS A S D F G H J K L : ' CAPS

Z X C V B N M , . / \

CLEAR

BASS SNARE RIM TOM HIHAT SYMBAL LAST NAME

To cancel the **Save Kit As** operation click **Quit**.

Click **Accept** when you are happy with the name. The new Kit will have the same Drums and Samples as before but will have the new Kit Mixer Settings. This is now the Active Kit.

If the name you have chosen already exists, a **Name Exists Window** will appear :

NAME ALREADY EXISTS

RENAME Change its Name

REPLACE Overwrite it

QUIT

This gives you the option to **Rename** the current Kit, using the Alphanumeric Keyboard again, **Replace** the Kit, overwriting it with the same name, or **Quit** the **Save As** operation.

LOADING OTHER KITS

Other Kits can be loaded from this Screen allowing you to make another Kit Active and view it's Mixer settings.

Loading Kits from Memory

Select **Load Kit** from the **Memory** menu to load a Kit from those currently in Memory. If you have not saved recent changes to the Mixer settings in the Active Kit, a **Save Changes Window** will appear :

SAVE CHANGES TO KIT ?

SAVE Keep it

LOSE Lose it forever

CONT Continue with it

This gives you the option to **Save** any changes before loading the new Kit, **Lose** them leaving the Kit as it was before changes were made, or cancel the Load operation and **Continue** with the current Kit. A **Load Memory Catalog** will now be displayed unless you cancelled the operation from the Save Changes Window.

5 Entries

CATALOG

1 Ambient 1

2 Dry Kit 1

3 Dry Kit 2

X 4 Dry Kit 3

5 System Kit

LOAD MEMORY KIT

ACCEPT

QUIT

To select a Kit place the Pointer on the name of the one you want, and click. The Selected Kit will be indicated by a cross. Click **Accept** to load the Kit. If there are more than 11 entries, the other kits can be viewed by clicking the scroll arrows. The double arrows will scroll a page at a time while single arrows scroll a line at a time.

The selected Kit name will appear at the top of the Screen and the new Mixer settings will be displayed. This Kit is now Active.

Loading Kits from Disk

Kits can also be loaded from Disk by selecting **Load Kit** from the **Disk** menu. The selected Kit will be loaded into Memory and become Active. To save Memory space only Drums and Samples which are not already in Memory will be loaded. If you have not saved recent changes to the Mixer settings, the **Save Changes Window** will appear as described above.

A **Load Disk Catalog** will now be displayed unless you cancelled the operation from the Save Changes Window.

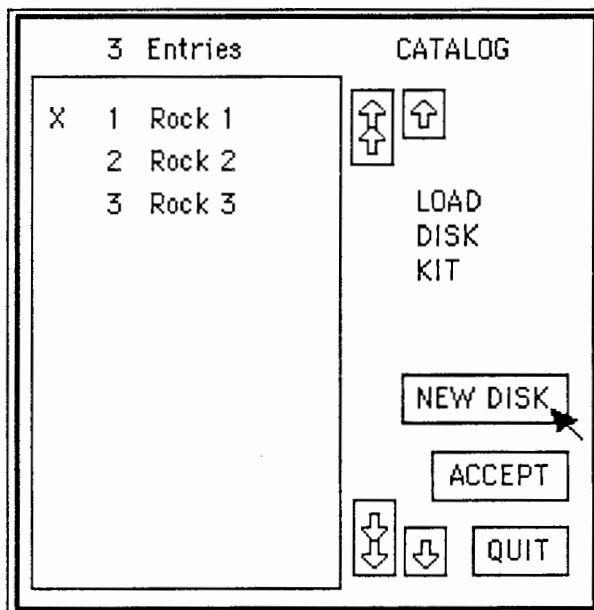

If you wish to view or select kits on another Disk, replace the Disk in the Drive and click **New Disk**. The Catalog will now list the kits on the new Disk.

Select the Kit to be loaded from the Catalog and click **Accept** to load it.

The selected Kit name will appear at the top of the Screen and the new Mixer settings will be displayed. This Kit is now Active.

SPECIAL MIXER FUNCTIONS

Initialise Mixer

If you have been experimenting with the Mixer settings and you decide that you want to reset **All** the controls, you can select **Initialise Mixer** from the **Special** menu to do this for you. This useful function will reset Length to maximum, Tune to zero, Pan to the centre and Volume to maximum on all of the sixteen Pads

Set All Mute/Solo Off

If you have a number of Channels Muted , either individually or by a Soloed Channel, you can clear all of the Mute and Solo Switches by Selecting **Set All Mute/Solo Off** from the **Special** menu.

Set Pot and Slider Ranges

Selecting **Set Pot & Slider Ranges** from the **Special** menu open a **Range Window**:

SET MIXER SENSITIVITY		
Length/Tune & Pan Pots		Volume Slider
()	Fine	()
(o)	Medium	()
()	Course	()
()	Very Course	()
()	Extremely Course	(o)
<input type="button" value="ACCEPT"/>		

This allows the 'gearing' of the Tracker Ball to be adjusted so that you can make coarse or fine adjustments to the pots and sliders.

LEAVING THE KIT MIXER SCREEN

Once you have finished working with the Kit Mixer you can return to the Kit Select Screen by pointing to the **NEXT** box, holding the Select button to show the **Next Menu**, rolling the Tracker Ball down until the arrow is pointing to **Quit** and releasing the Select button.

If you have altered the Mixer settings, but have not saved them yet, the **Save Changes Window** will be displayed, before you can leave the Kit Mixer.

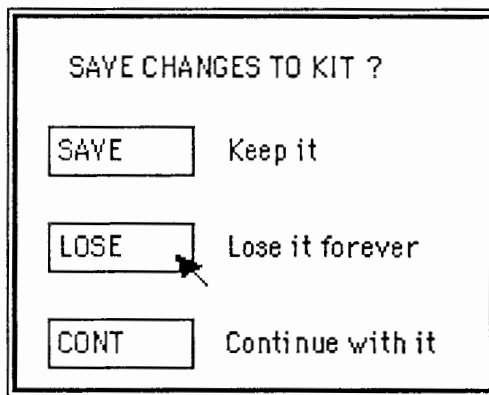

Save

If you wish to keep the recent changes, click on the **Save** box. The **Name Exists Window** will appear again.

You can **Replace** the active Kit with the changes, **Rename** it to create another with the new Mixer settings, leaving the original intact, or **Quit** to cancel the Save operation and remain on the Kit Mixer Screen.

Lose

If you don't want to save any changes, click on the **Lose** box. This leaves the settings of the Mixer as they were when you loaded the Kit, losing the changes you made. The Kit Select Screen will now be displayed.

Cont

If you selected **Quit** from the **Next Menu** by mistake, or changed your mind about leaving the Kit Mixer, you can cancel the Quit operation and continue with the Screen, by clicking the **Cont** box.

Creative Use of SDX

Section 4.2

Using SDX: Kit Configuration Screen

CONTENTS

What is a Kit ?	4 - 11	Moving to the Kit Mixer Screen	4 - 28
Selecting the Kit Configuration Screen	4 - 13	Editing Drums	4 - 29
Other 8	4 - 13	What is a Drum ?	4 - 29
Selecting the Pad Type	4 - 14	Drum Samples	4 - 29
Pad 1 - Bass	4 - 14	Drum Head	4 - 29
Pad 2 - Snare	4 - 14	Making your own Drums	4 - 31
Pad 3 - Rim	4 - 14	Sample Assign	4 - 31
Pads 4 - 16 Tom, Symbal, Pitched or Hi-Hat.	4 - 15	Drum Head	4 - 31
Assigning Drums	4 - 16	Leaving the Kit Configuration Screen	4 - 32
Selecting other Drums from Memory	4 - 16	Save	4 - 32
Selecting other Drums from Disk	4 - 17	Lose	4 - 32
Voice Assignment	4 - 18	Cont	4 - 32
Voice Rotation	4 - 18		
Voice Robbing	4 - 18		
Assigning Voices to a Pad	4 - 18		
Individual Voice Outputs	4 - 18		
Special Voice Functions	4 - 19		
Edit MIDI	4 - 21		
MIDI Note	4 - 22		
Assigning a MIDI Note to a Pad	4 - 22		
Selecting a MIDI Note Range	4 - 22		
MIDI Channel	4 - 23		
Assigning a MIDI Channel to a Pad	4 - 23		
Special MIDI Functions	4 - 23		
Saving your Changes	4 - 25		
Save Kit	4 - 25		
Save Kit As	4 - 25		
Alphanumeric Keyboard Window	4 - 25		
Loading other Kits	4 - 26		
Loading Kits from Memory	4 - 26		
Loading Kits from Disk	4 - 27		

Creative Use of SDX

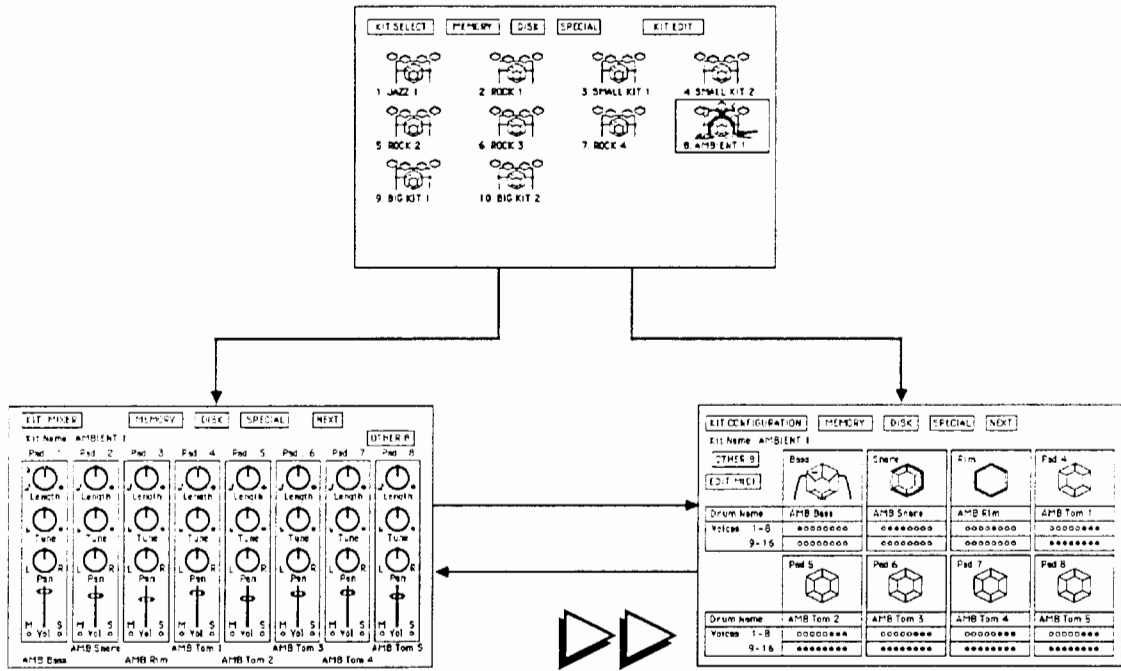

So far you should have used the **Kit Select Screen** to load Kits from your Sound Disks and used the **Kit Mixer Screen** to adjust the Length, Tuning, Pan position and Level of the Drums in the Active Kit.

WHAT IS A KIT?

Before going any further, let's look at what makes a Kit.

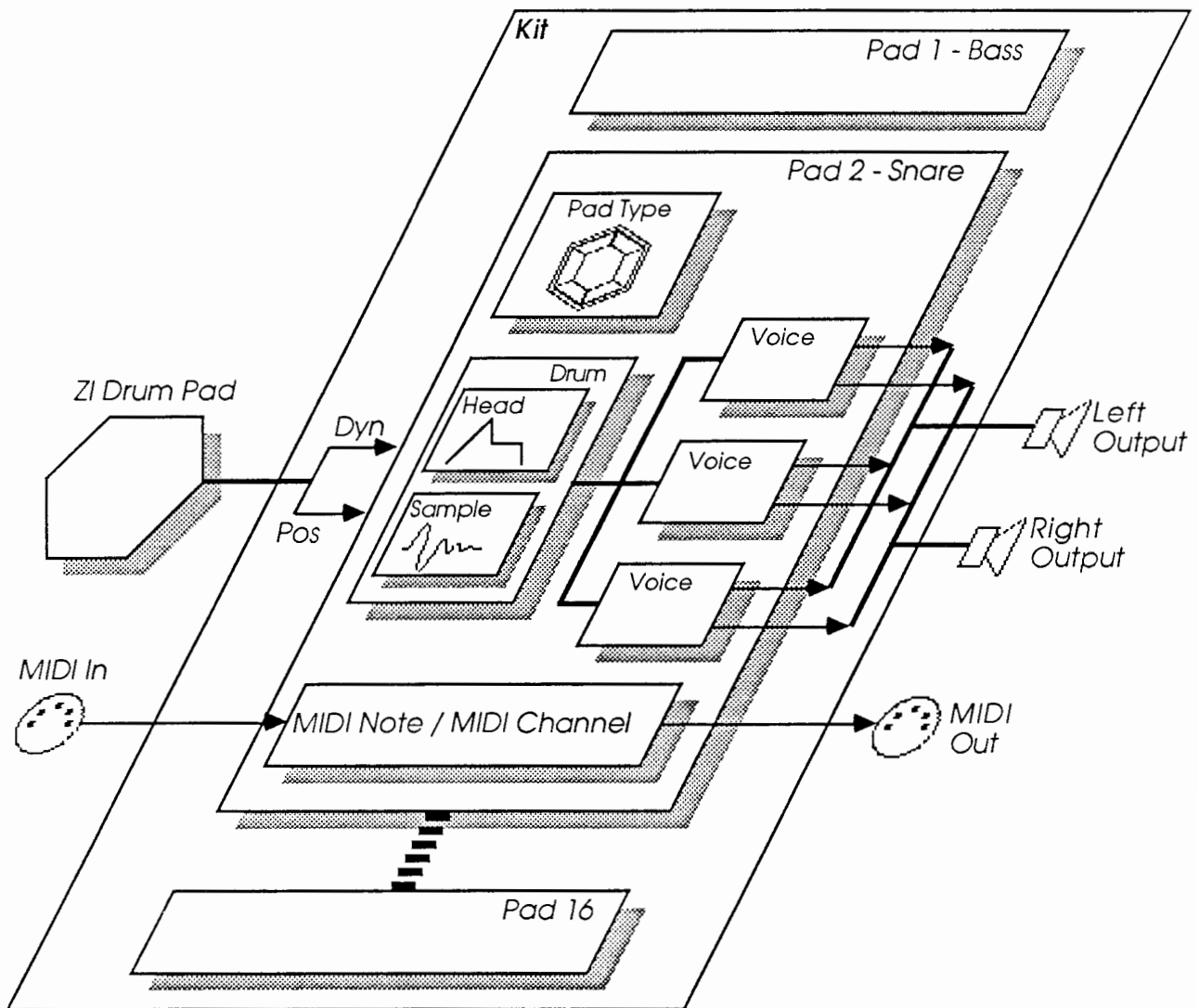

Each Kit is a configuration of 16 **Pads**. The diagram shows the Pads which make up a Kit and the components which make up Pad 2, the Snare. All the other Pads have the same basic construction, but may have a different number of Voices.

When a Kit is selected, SDX loads the following components for each of the 16 Pads. Using the **Kit Configuration Screen**, you can view these components or change them to make up your own Kits.

- **Pad Type**
Pad type can be **Bass, Snare, Rim, Tom, Symbal, Hi-Hat** or **Pitched**. Selecting a Pad Type effects the characteristics that Pad will have on other Screens.
- **Drum**
Drum **defines** the sound that is created when the Pad is hit. It has two main components - A **Head** and **Samples**.
- **Voice Assignment**
A Voice **creates** the Drum sound by combining the digitally recorded Drum Sample and the Drum Head information. Each Pad can be assigned any number of SDX's 16 Voices. The Snare Pad has a default of 3 Voices.
- **MIDI Note**
As well as playing the Drum Sound, hitting a Pad will cause a MIDI Note to be transmitted from **MIDI Out**. This allows external MIDI Keyboards or Voice Expanders to be triggered from SDX.
- **MIDI Channel**
Selecting different MIDI Channels allows the Notes transmitted from Pad hits to be sent to different MIDI instruments.
- **MIDI Program**
Each Kit can have a MIDI Program Change assigned. This will be transmitted when the Kit is made Active. If any Pads are assigned to different MIDI channels, the program Change will be sent on each of the different Channels.

4 - 12 MIDI Program Changes are transmitted on the Bass Pad's channel only.

SELECTING THE KIT CONFIGURATION SCREEN

If you are still on the **Kit Select Screen**, point to the **KIT EDIT** box, then press and hold the Select Button to display the **Kit Edit Menu**. Roll the Tracker Ball downwards to the second choice, **Kit Configuration**, then release the Select Button. If you are on the **Kit Mixer Screen**, select the **Next Menu** and choose **Kit Configuration**.

The screenshot shows the 'KIT CONFIGURATION' screen for 'AMBIENT 1'. At the top, there are buttons for 'KIT CONFIGURATION' (with an arrow pointing to it), 'MEMORY', 'DISK', 'SPECIAL', and 'NEXT'. Below the buttons, the 'Kit Name' is 'AMBIENT 1'. On the left, there are 'OTHER 8' and 'EDIT MIDI' buttons. The main area is a grid of 8 drum/pad settings, each with a 3D icon, a name, and two rows of 'Voices' (1-8 and 9-16) represented by circles (filled for active, empty for inactive).

Drum Name	AMB Bass	AMB Snare	AMB Rim	AMB Tom 1
Voices 1-8	●○○○○○○○	●●●○○○○○	○○○○●○○○	○○○○○○●●
Voices 9-16	○○○○○○○○	○○○○○○○○	○○○○○○○○	●●●●●●●●

Drum Name	AMB Tom 2	AMB Tom 3	AMB Tom 4	AMB Tom 5
Voices 1-8	○○○○○○●●	○○○○○○●●	○○○○○○●●	○○○○○○●●
Voices 9-16	●●●●●●●●	●●●●●●●●	●●●●●●●●	●●●●●●●●

The **Kit Configuration Screen** is now displayed. This is one level down from the Kit Select Screen, since we are inside the active Kit. Think of it as being on the same level as the Kit Mixer, but viewing the Pad parameters within the Kit. The Active Kit name is displayed at the top of the screen.

When you loaded your Kit from the **Kit Select Screen**, SDX automatically loaded all the Pad Types, Drums, Voices, MIDI Notes, and Channels for the 16 Pads in this Kit.

OTHER 8

When you first enter this Screen, Pads 1 to 8 will be displayed. You can alternate between the two sets of Pads by clicking on the **OTHER 8** box. Click once to view Pads 9 to 16, click again to return to Pads 1 to 8. You can also alternate between the two sets of pads by clicking the right - hand Select Button.

SELECTING THE PAD TYPE

The type of Pad currently assigned is indicated by an icon under the Pad name. If you wish to change the Pad Type, point at the icon to be changed and click. Apart from the first 3 Pads which are fixed as **Bass**, **Snare** and **Rim**, you can have any combination of **Toms**, **Symbols**, or **Pitched** Drums and one **Hi-Hat**.

Pad 1 - Bass

Clicking on the Bass icon produces a **Select Pad Type** Window.

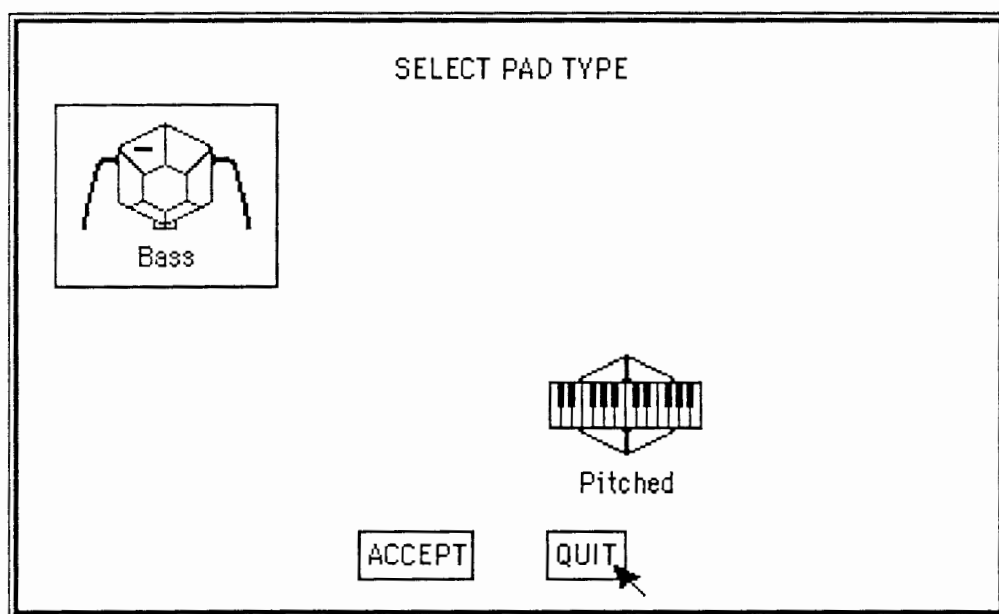

Two icons are displayed, Bass and Pitched. These are the only ones which can be assigned to the Bass Pad. If you wish to make the Bass Pad pitched point at the **Pitched** icon and click, then click on **Accept**. The window disappears and the Pitched icon appears as the Bass Pad. To change back to the Bass Pad click on the Pitched icon to open the Pad Select Window again, select the Bass icon and click **Accept**.

Pad 2 - Snare

Click on the Snare icon to open the **Select Pad Type** Window again. This time Snare and Pitched icons appear. These are the only ones which can be assigned to the Snare Pad. If you wish to make the Snare Pad pitched point at the **Pitched** icon and click, then click on **Accept**.

Pad 3 - Rim

Click on the Rim icon to open the **Select Pad Type** Window again. Bass, Rim and Pitched appear this time. These are the only ones which can be assigned to the Rim of the Snare Pad. Bass is provided so that you can have two Bass Drums in your Kit. To do this point at the **Bass** icon and click, then click on **Accept**.

Pads 4 -16 Tom, Symbal, Pitched or Hi-Hat.

Clicking on any of the other icons produces the following **Select Pad Type** Window :

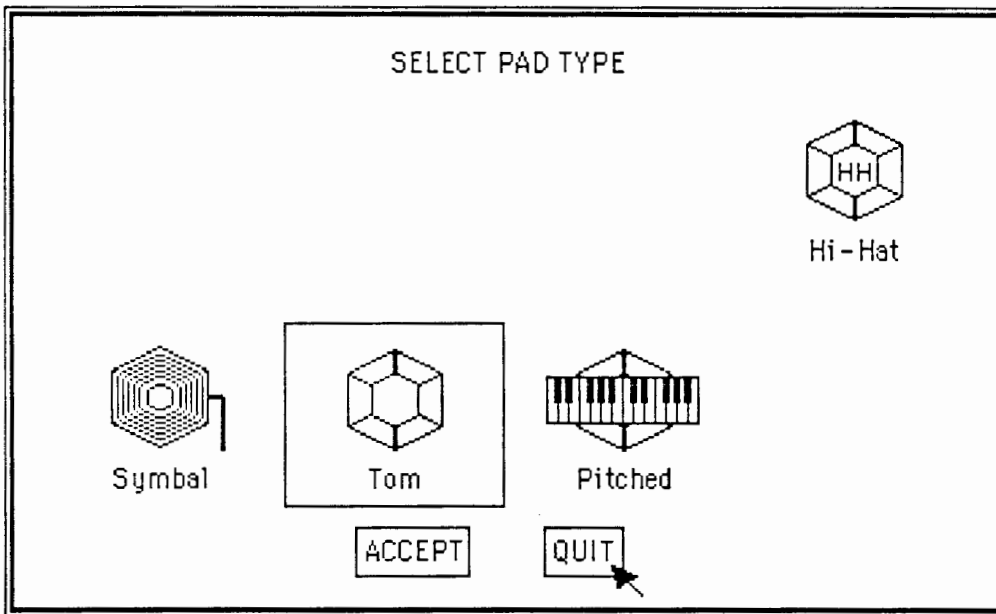

V 1.2
The **Pad Type as Default** option now con-
sures the pads as follows:

- | | |
|---------------|-----------------|
| Pad 1 - Bass | Pad 9 - Symbal |
| Pad 2 - Snare | Pad 10 - Symbal |
| Pad 3 - Rim | Pad 11 - Symbal |
| Pad 4 - Tom | Pad 12 - Symbal |
| Pad 5 - Tom | Pad 13 - Symbal |
| Pad 6 - Tom | Pad 14 - Symbal |
| Pad 7 - Tom | Pad 15 - Symbal |
| Pad 8 - Tom | Pad 16 - Hi-Hat |

Tom, Symbal, Pitched and Hi-Hat icons are displayed. These can be assigned to any of the remaining Pads. The only restriction is that you can only have one Hi-Hat. To select your Hi-Hat Pad point at the **Hi-Hat** icon and click, then click on **Accept**. The Hi-Hat Pedal will always operate the Pad you have chosen.

Special Pad Functions

The **Special Menu** contains two Functions which help with selecting Pad Types. Point to the **SPECIAL** box and select to display the Special Menu.

Choose **Pad Type as Default** to set all 16 Pad Types to their default setting :

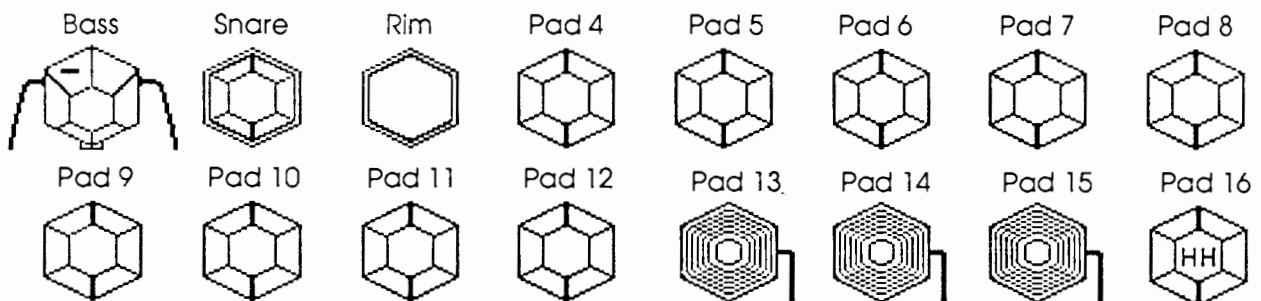

Choose **Pad Type All Pitched** to set all 16 Pads to be Pitched.



ASSIGNING DRUMS

When you loaded your Kit, SDX automatically loaded all the Drums required by that Kit. You can see the Drums which are assigned to each Pad by the **Drum Name** under the Pad's icon.

Selecting other Drums from Memory

You can change the Drums currently in the Kit by replacing them with others from Memory or Disk. Place the Pointer on the **Drum Name** of the Snare Pad, and Click. A **Kit/Drum Assigning** Window appears.

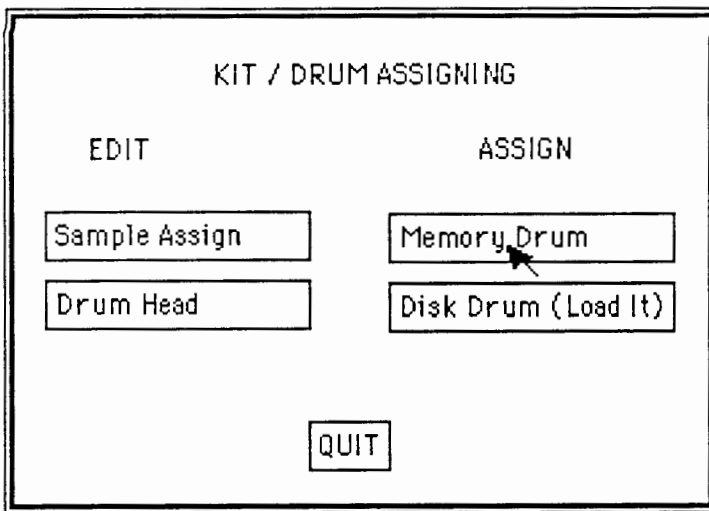

4-16 The **Kit/Drum Assigning** Window now has another option, **New Drum**, see 4-31.

This window allows other Drums to be selected from Memory, by clicking **Memory Drum**, or loaded from Disk by clicking **Disk Drum**. Click **Memory Drum**. The **Kit/Drum Assigning** Window is replaced by a **Load Memory Drum Catalog**.

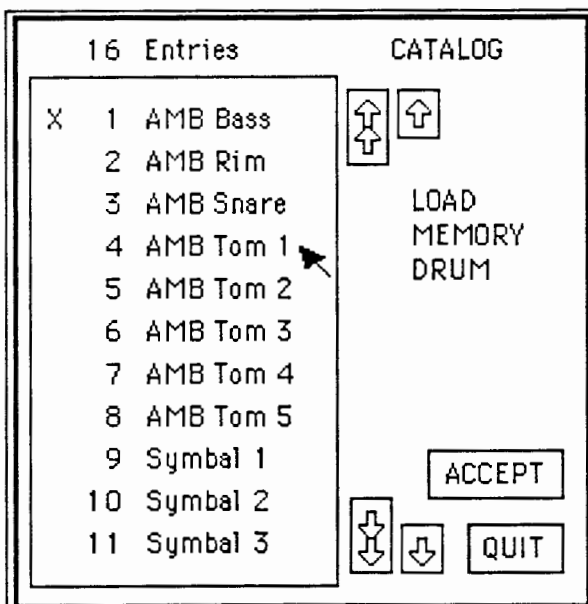

All the Drums which are currently in Memory are displayed in the Catalog. Point to Entry 4, **AMB Tom 1** and click. The Entry will now be marked with a Cross. Click **Accept** to select this Drum. The Catalog Window closes and the Snare Pad now has **AMB Tom 1** displayed as its Drum Name.

Try playing the new Snare. The sound has changed to an Ambient Tom, the same as that produced by playing Pad 5. Note that the Rim sound hasn't changed and is still produced when the Rim of the Snare pad is hit.

Click on the Snare's Drum Name to open the **Kit/Drum Assigning** Window again and click **Memory Drum**. Select Entry 3, **AMB Snare** and click **Accept**. The Snare Pad displays **AMB Snare** again. Try playing the Snare Pad to check that the original sound has returned.

Selecting other Drum from Disk

Click on the Snare's Drum Name again to open the **Kit/Drum Assigning** Window, but this time click on **Disk Drum**.

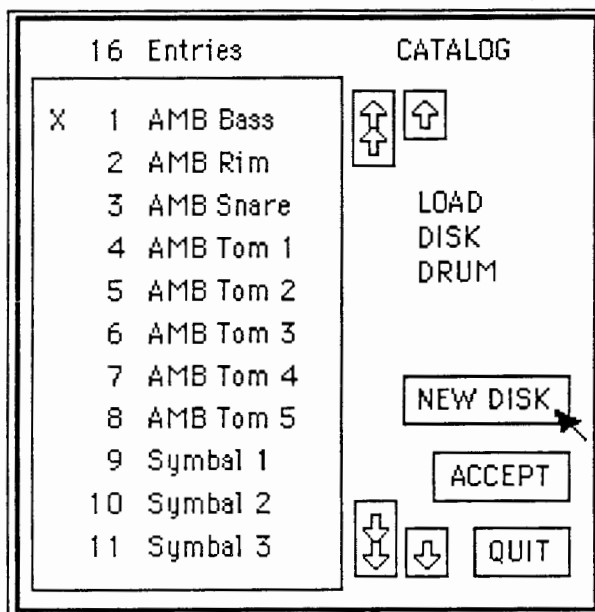

All the Drums which are currently on the Disk in the Drive are displayed in the Catalog. If you haven't changed Disks since you loaded the Kit, the Drums will be the same as the ones you have in your Active Kit. Remove the Disk from the drive and replace it with another one of your Sound Disks. Now point to **New Disk** and click. The Catalog will now show all the Drums on the Disk you have just inserted. Choose a Drum from the new entries and click **Accept**.

The Disk drive will become active and a **Loading Drum ... Please Wait** message will appear until the Drum is loaded. The Drum Name you have chosen now appears under the Snare icon.

Try playing the new Snare.

You can see how easy it is to customise the Kits supplied from your Sound Disks, constructing new unique Kits, simply by mixing the Drum sounds. Once you have created a Kit you particularly like, you can save it to a new Disk.

VOICE ASSIGNMENT

If you have only **one** Voice per Pad, the Voice will restart the sound creation process every time it is hit. Fast rolls or flams, can sound rather unnatural - the 'machine gun' effect !

To avoid sounding artificial, SDX allows several of its 16 Voices to be assigned to one Pad. The default setting for the Snare Pad is 3 Voices.

Voice Rotation

When several Voices are assigned to one Pad, they are used in **Rotation**. Take the Snare Pad for example. On the first hit, the first Voice will start to create the Snare sound. If hit again, the second Voice will start to create the same Snare sound while the first is decaying. If hit again, the third Voice will sound while the other two are decaying. This provides a much more natural simulation of what happens in an acoustic Snare.

Voice Robbing

If a Pad is hit while all of its Voices are sounding, a **Voice Robbing Algorithm** is used. This is a rule which causes the one with the lowest Dynamic level to be 'stolen', that is stopped and restarted with the Dynamic of the new hit. Stealing the quietest hit makes the re-start process almost unnoticeable.

Assigning Voices to a Pad

There are 16 Voices available in SDX. The Voice Assignment for each Pad is shown as two rows of circles, called switches, under each Drum Name. The top row represents **Voices 1 to 8** and the bottom row, **Voices 9 to 16**.

When a switch is on its circle is filled, indicating that the Voice has been assigned to that Pad. Conversely, when a switch is off and the circle is empty, the Voice is not assigned to that Pad.

To assign a Voice which is off, simply point to the Voice's switch and click it on. Click again to turn it off.

When the same Voice is assigned to more than one Pad, it is known as a **Shared Voice**.

Individual Voice Outputs

Individual Voice Outputs are provided to allow Voices to be connected to an external Mixer or treated using outboard Effects. These Outputs, available via sockets situated on the rear panel of the SDX Console, are monophonic and will not be effected by the Pan or Volume settings on the Kit Mixer Screen.

Note: Voice Outputs 1-16 do not automatically correspond to Pad Inputs 1-16.

Each Voice Output corresponds directly to its switch on the Kit Configuration Screen. Therefore, to make the Bass Drum sound come from Voice Output 1, you must switch on Voice 1 in the Bass Drum.

If you assign more than one Voice to a Pad, creating a **Multi-Voice** Drum, the sound will Rotate around each of the corresponding Voice Outputs. Therefore you will need an external mixer to create a Multi-Voice Drum from the Individual Outputs.

Since the most common Multi-Voice Drum will be the Snare. A separate **Snare Output** is available which provides a mixed version of Voices 2, 3 and 4. These are assigned to the Snare Pad by default.

Special Voice Functions

The **Special Menu** contains three Functions which help with Voice Assignments. Point to the **SPECIAL** box and select to display the Special Menu.

- Choose **Voice Assign as Default** to set all Pads to their default Voice assignment :

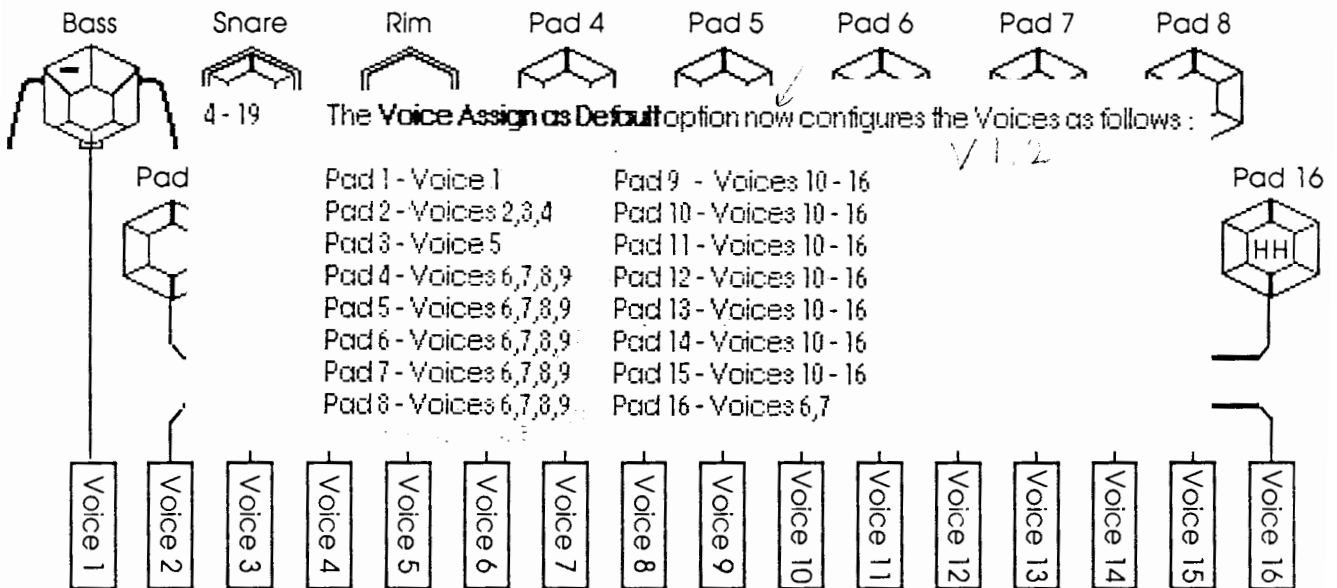

Bass is assigned to Voice 1
 Snare is assigned to Voices 2, 3 and 4
 Rim is assigned to Voice 5
~~Pads 4 - 16 are assigned to share the remaining 11 Voices~~

Unless all 16 Individual Outs are connected to a Mixer, this should only be selected when using the Stereo Output.

Creative Use of SDX

- Choose **Voice Assign 1 to 1** to assign one Pad to one Voice.
Bass will use Voice 1, Snare uses Voice 2 and so on up to Pad 16 using Voice 16.

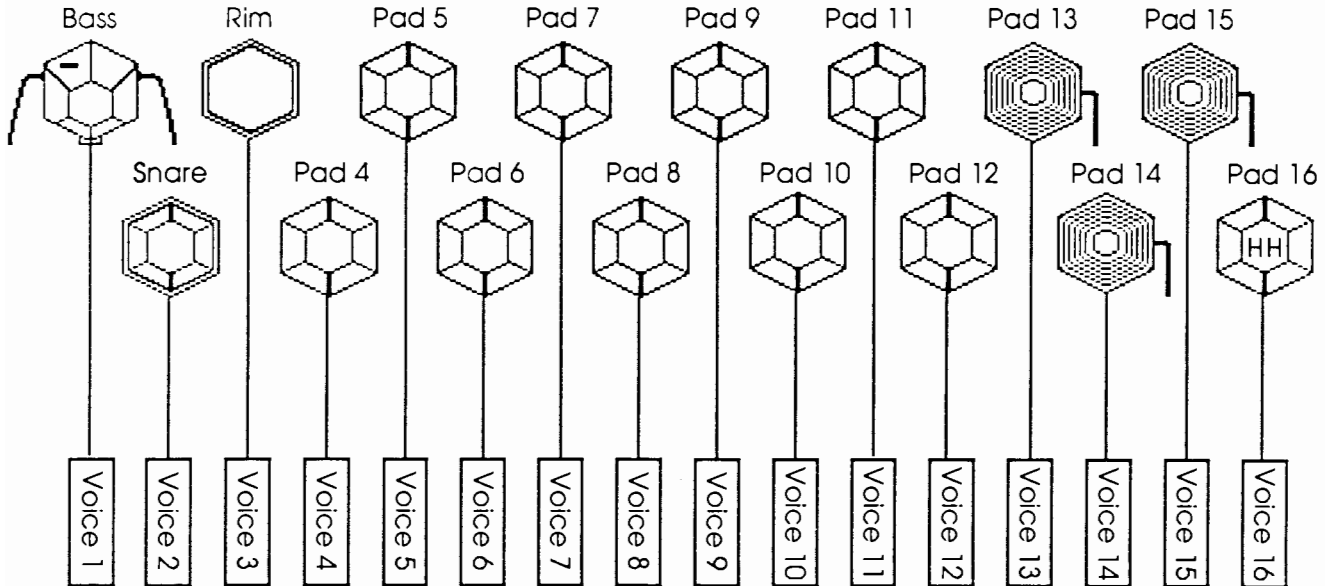

This should be selected when using Individual Outputs.



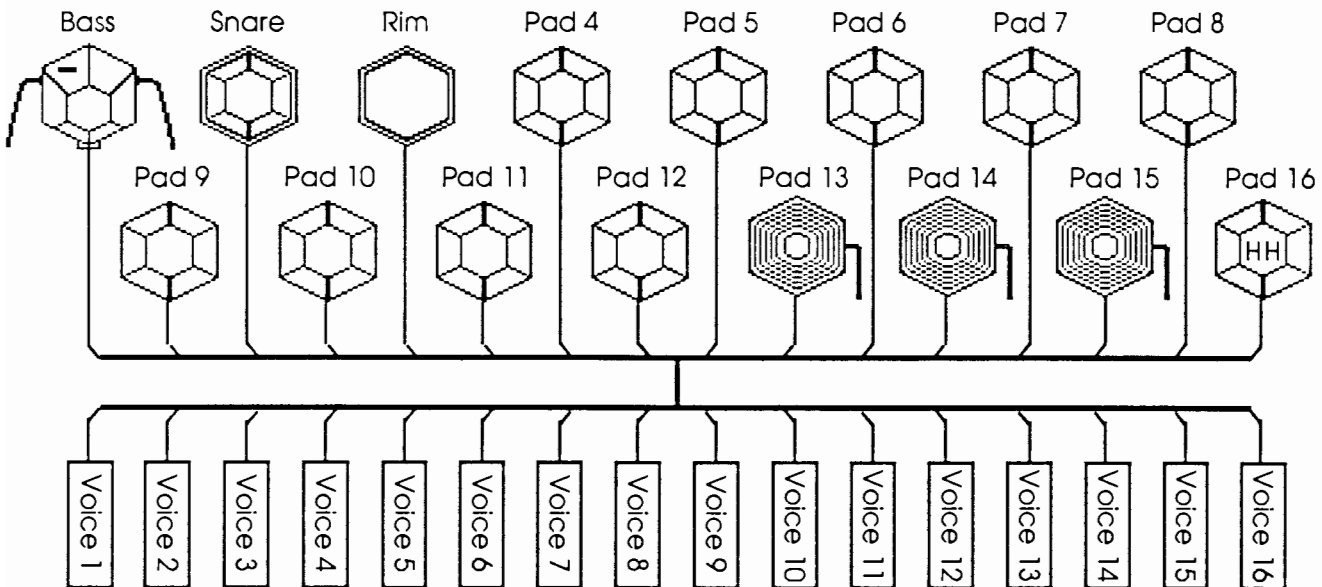

- Choose **Voice Assign All to All** to assign all 16 Pads to all 16 Voices. This means that any Pad can use any Voice, using the Rotational and Robbing Algorithms discussed previously.

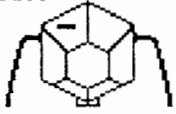
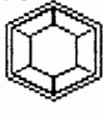
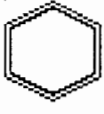
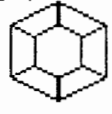

Unless all 16 Individual Outs are connected to a Mixer, this should only be selected when using the Stereo Output.

EDIT MIDI

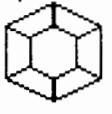
Clicking on the **EDIT MIDI** box will change the Voice Assignment Switches into a MIDI Note and Channel for each Pad. The box name also changes to **EDIT VOICE**. The Kit Configuration Screen now looks as follows :

KIT CONFIGURATION					MEMORY	DISK	SPECIAL	NEXT
Kit Name : AMBIENT 1								
OTHER 8	Bass	Snare	Rim	Pad 4				
EDIT VOICE								
Drum Name	AMB Bass	AMB Snare	AMB Rim	AMB Tom 1				
MIDI Note	60	61	62	63				
Channel	1	1	1	1				
MIDI Prog: 6	Pad 5	Pad 6	Pad 7	Pad 8				
								
Drum Name	AMB Tom 2	AMB Tom 3	AMB Tom 4	AMB Tom 5				
MIDI Note	64	65	66	67				
Channel	1	1	1	1				

Clicking on **EDIT VOICE** will cause the Voice Assignment Switches to be displayed again. Alternating between these two displays does not effect MIDI or Voice Assignments.

MIDI PROGRAM

A MIDI Program Number is displayed on the Screen, next to **MIDI Prog**. This Program Change will be transmitted from **MIDI Out** when the Kit is made Active. To Change the assigned MIDI Program place the Pointer on the number, then press and hold the Select Button. A numeric box will appear allowing you to increase the Program number, by rolling the Tracker Ball upwards, or decrease it by rolling downwards. Any value from 1 to 128 can be selected.

MIDI NOTE

As well as playing the Drum Sound, hitting a Pad will cause it's MIDI Note to be transmitted with the Pad Dynamic from **MIDI Out**. If the Pad Type is **Pitched** then a Range of MIDI Notes can be played, by altering the strike Position on the Pad.

When a MIDI Note is received at **MIDI In** it will be compared to the Channels then Notes, assigned to the 16 Pads. If a match is found, the corresponding Drum will be played at its current Pitch, but with the received MIDI Dynamic Level. If the Pad Type is **Pitched** then the Drum will be played at the Pitch of the incoming MIDI Note, provided that it is within the assigned Range.

Assigning a MIDI Note to a Pad

Place the pointer on the MIDI Note of the Pad you wish to change, then press and hold the Select Button. A numeric box will appear allowing you to increase the Note Number, by rolling the Tracker Ball upwards, or decrease it by rolling downwards.

Any value from 0 to 127 can be selected.

When a Pad is hit it's assigned MIDI Note will be transmitted, with the strike dynamic value, from MIDI Out. If the same MIDI Note is received at MIDI In, the corresponding Pad will be triggered with the received MIDI Dynamic value.

Selecting a MIDI Note Range

If the Pad Type is **Pitched** two MIDI Notes will be displayed. These allow a MIDI Note Range to be selected. Place the pointer on the left hand MIDI Note of the Pitched Pad you wish to change, then press and hold the Select Button. A numeric box will appear allowing you to adjust the **Lower Note** of the Range. Select the right hand MIDI Note and a numeric box will appear allowing you to increase the **Upper Note** of the Range.

When a Pad is hit the MIDI Notes transmitted from **MIDI Out** will be chosen from the assigned MIDI Note Range according to the Position of the strike. If hit in the centre the lowest Note will be played. If hit at the edge the highest Note will be played.

If a MIDI note, within the assigned range, is received at **MIDI In**, the corresponding Pad will play at the MIDI Pitch with the MIDI Dynamic value.

4 - 22

When the Pad type is **Pitched** and a **MIDI Note Range** is displayed, MIDI Notes received at MIDI In will pitch the Drum, provided they are within range. MIDI Notes transmitted from MIDI Out will not change with Position, as stated. Only the Lower Note of the Range will be transmitted.

MIDI CHANNEL

Selecting different MIDI Channels allows the MIDI Notes transmitted from Pad hits to be sent to different MIDI instruments. If you wish to drive SDX from a MIDI Sequencer you can assign each of the Pads to a separate Channel. Each Pad can then be controlled individually and multi-tracked.

Assigning a MIDI Channel to a Pad











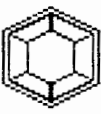

Place the pointer on the MIDI Channel of the Pad you wish to change, then press and hold the Select button. A numeric box will appear allowing you to increase the Channel Number, by rolling the Tracker Ball upwards, or decrease it by rolling downwards.

Any Channel from 1 to 16 can be selected.

SPECIAL MIDI FUNCTIONS

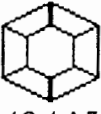
The **Special Menu** contains four Functions which help with MIDI Assignments. Point to the **SPECIAL** box and select to display the Special Menu.

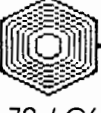
- Choose **MIDI Notes as Default** to set all Pads to their default MIDI Note settings :

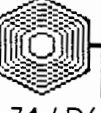
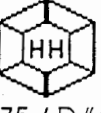
Bass  60 / C5 Pad 5	Snare  61 / C#5 Pad 6	Rim  62 / D5 Pad 7	Pad 4  63 / D#5 Pad 8
 64 / E5 Pad 9	 65 / F5 Pad 10	 66 / F#5 Pad 11	 67 / G5 Pad 12
 68 / G#5 Pad 13	 69 / A5 Pad 14	 70 / A#5 Pad 15	 71 / B5 Pad 16
 72 / C6	 73 / C#6	 74 / D6	 75 / D#6

- Choose **MIDI Channel as Default** to set all Pads to their default MIDI Channel settings :

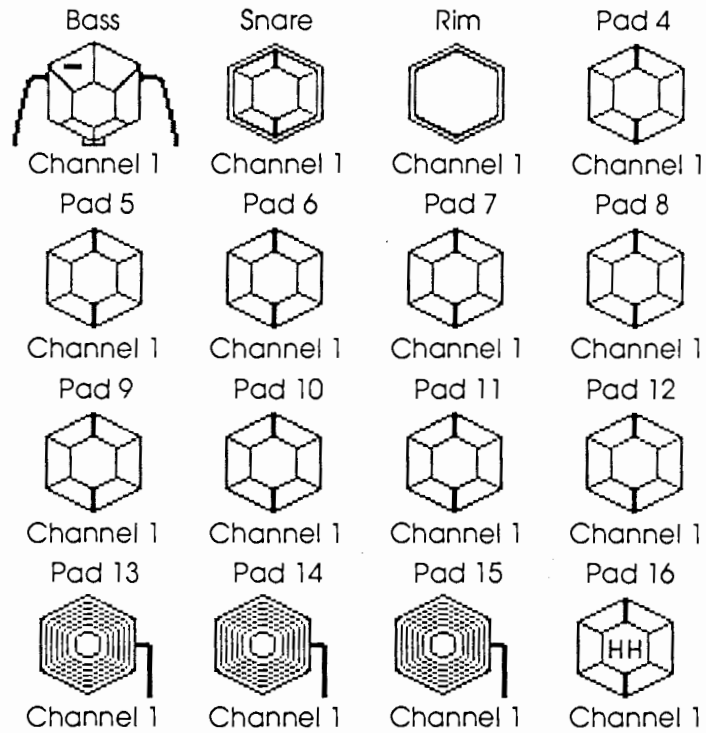

- Choose **MIDI Note Decimal** to display Notes in Numeric format.

Note numbers range from 0 to 127, middle C = 60. *ok 257*

- Choose **MIDI Note Chromatic** to display Notes in Chromatic format.

Values range from C0 to G: where ':' = Octave 10.

SAVING YOUR CHANGES

Once you have constructed your own custom Kit you'll probably want to keep it. You can either save the changes to Memory - remember that these will be lost when you power down - or save them to Disk.

Save Kit

Selecting **Save Kit** from the **Memory** menu will save any changes made to the Kit Configuration as part of the Active Kit in Memory, replacing the previous settings with current values. This will not effect the same Kit on your Disk. You should select **Save Kit** from the **Disk** menu if you wish to save the Configuration as part of the Kit on Disk. *A NAME EXISTS WINDOW WILL OPEN. CLICK ON REPLACE TO OVERTWRITE CURRENT KIT*

Save Kit As

Selecting **Save Kit As** from the **Memory** menu will save the Configuration as a new Kit in Memory, leaving the previous one as it was. Selecting **Save Kit As** from the **Disk** menu will save any changes as a new Kit on Disk. The Disk must be Unprotected.

When **Save Kit As** is chosen, an **Alphanumeric Keyboard Window** appears on screen allowing the new Kit to be named.

Name : AMBIENT 2

ACCEPT QUIT

1 2 3 4 5 6 7 8 9 0 - = " Del

q w e r t y u i o p [] { }

caps a s d f g h j k l : ' caps

z x c v b n m , . / \

CLEAR

bass snare rim tom hihat symbal LAST NAME

Alphanumeric Keyboard Window

To enter your new Kit name, using up to 11 characters, simply click on the letter or numbers in sequence. Upper case letters can be selected by clicking **Caps**. Click **Del** if you want to back-space or **Clear** to clear the entry. Common Drum names and the **Last Name** used are also available and are typed when clicked.

To cancel the **Save Kit As** operation click **Quit**.

Click **Accept** when you are happy with the name. The new Kit will have the same Drums and Samples as before but will have the new Kit Configuration. This is now the Active Kit.

If the name you have chosen already exists, a **Name Exists Window** will appear.

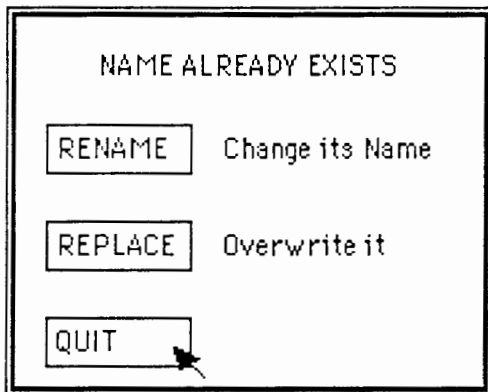

This gives you the option to **Rename** the current Kit, using the Alphanumeric Keyboard again, **Replace** the Kit, overwriting it with the same name, or **Quit** the **Save As** operation.

LOADING OTHER KITS

Other Kits can be loaded from this Screen allowing you to make another Kit active and view it's Configuration.

Loading Kits from Memory

Select **Load Kit** from the **Memory** menu to load a Kit from those currently in Memory. If you have not saved recent changes to the Configuration of the Active Kit, a **Save Changes Window** will appear :

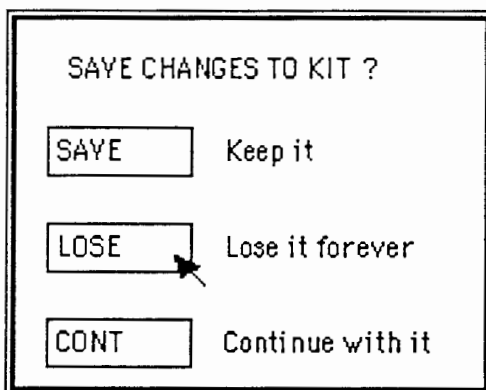

This gives you the option to **Save** any changes before loading the new Kit, **Lose** them leaving the Kit as it was before changes were made, or cancel the Load operation and **Continue** with the current Kit.

A **Load Memory Catalog** will now be displayed unless you cancelled the operation from the Save Changes Window.

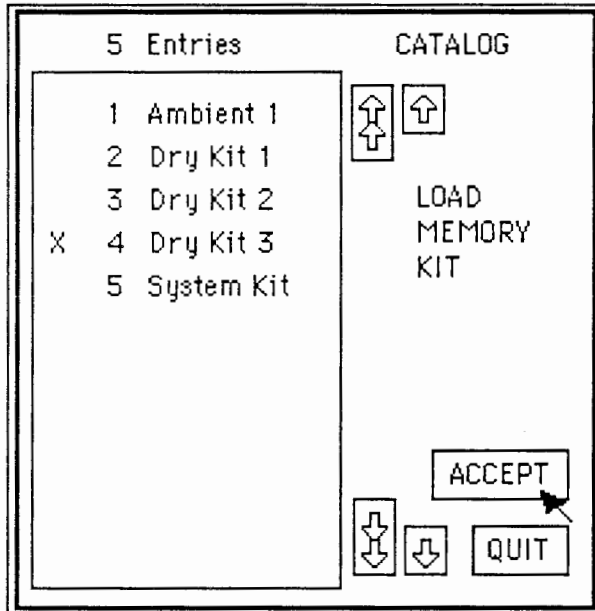

To select a Kit place the Pointer on the name of the one you want and click. The selected Kit will be indicated by a cross. Click **Accept** to load the Kit.

The selected Kit name will appear at the top of the Screen and the new Configuration will be displayed. This Kit is now Active.

Loading Kits from Disk

Kits can also be loaded from Disk by selecting **Load** from the **Disk** menu. The selected Kit will be loaded into Memory and become active. Only Drums and Samples which are not already in Memory will be loaded. If you have not saved recent changes to the Configuration, the **Save Changes Window** will appear as described above.

A **Load Disk Catalog** will now be displayed unless you cancelled the operation from the Save Changes Window.

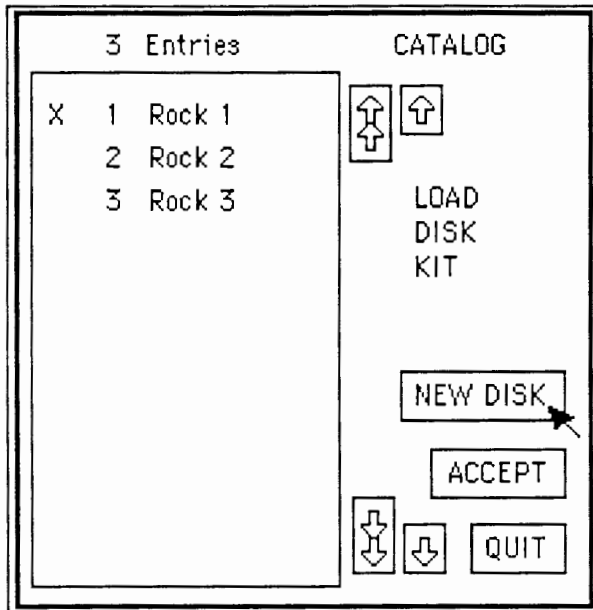

Select the Kit to be loaded from the Catalog and click **Accept** to load it.

The selected Kit name will appear at the top of the Screen and the new Configuration will be displayed. This Kit is now Active.

MOVING TO THE KIT MIXER SCREEN

While you are working with the Kit Configuration Screen you can move directly to the Kit Mixer Screen. Since both Screens are inside the Active Kit and therefore are on the same level, you can swap between them without saving any changes.

Point to the **NEXT** box, and while holding the Select Button to show the **Next Menu**, roll the Tracker Ball down until the arrow is pointing to **Kit Mixer**, then release the Select button. The Kit Mixer Screen is displayed. You can now carry out any changes to the Mixer settings as described in **Using the Kit Mixer**. To return to the Kit Configuration Screen again select **Kit Configuration** from the **Next Menu**.

When you **Quit** from either of these Screens, to return to the Kit Select Screen, the Save Changes Window will open, allowing all changes made to the Kit Mixer and Kit Configuration to be Saved.

EDITING DRUMS

So far you have loaded different Kits from your Sound Disks and made new Kits by selecting combinations of Drums. Let's take a look at how one of SDX's Drums is constructed.

What is a Drum ?

A Drum defines the sound that is created when a Pad is hit, using two main components - A **Sample** and a **Head**.

- A **Sample** is a digital recording of a real instrument, stored in memory. - It defines *what* sound is played.
- A **Head** is a collection of parameters which control the way in which the Drum changes in real-time. - It defines *how* the sound is played.

Both of these components can be effected by the **Dynamic**, or weight, of each stroke as well as the **Position**, to make the sound more responsive to your playing.

From the illustration, you can see that Drum Samples are processed by the Voice (or Voices - depending on the Voice assignment), while the Drum Head defines the way in which the Sample is processed, controlling components within each of the Voice(s).

Drum Samples

Most Drums are made up of 9 Samples, (Bass, Rim, Pitched and Hi-Hat are exceptions, but will be discussed later). A Sample is assigned to **Soff**, **Medium** and **Hard** hits for each of the **Centre**, **Inner** and **Outer** Positions on the Drum.

When the Pad is struck one of the Samples is selected, corresponding to weight and position of the strike, and played back through the voice.

Drum Head

The Head defines how the Sample will be played by the Voice. A Head is made up of a number of **Surfaces**. Each Surface determines how a specific parameter within the Voice varies in time. Each Surface can also be effected by the Dynamic and Position of the strike.

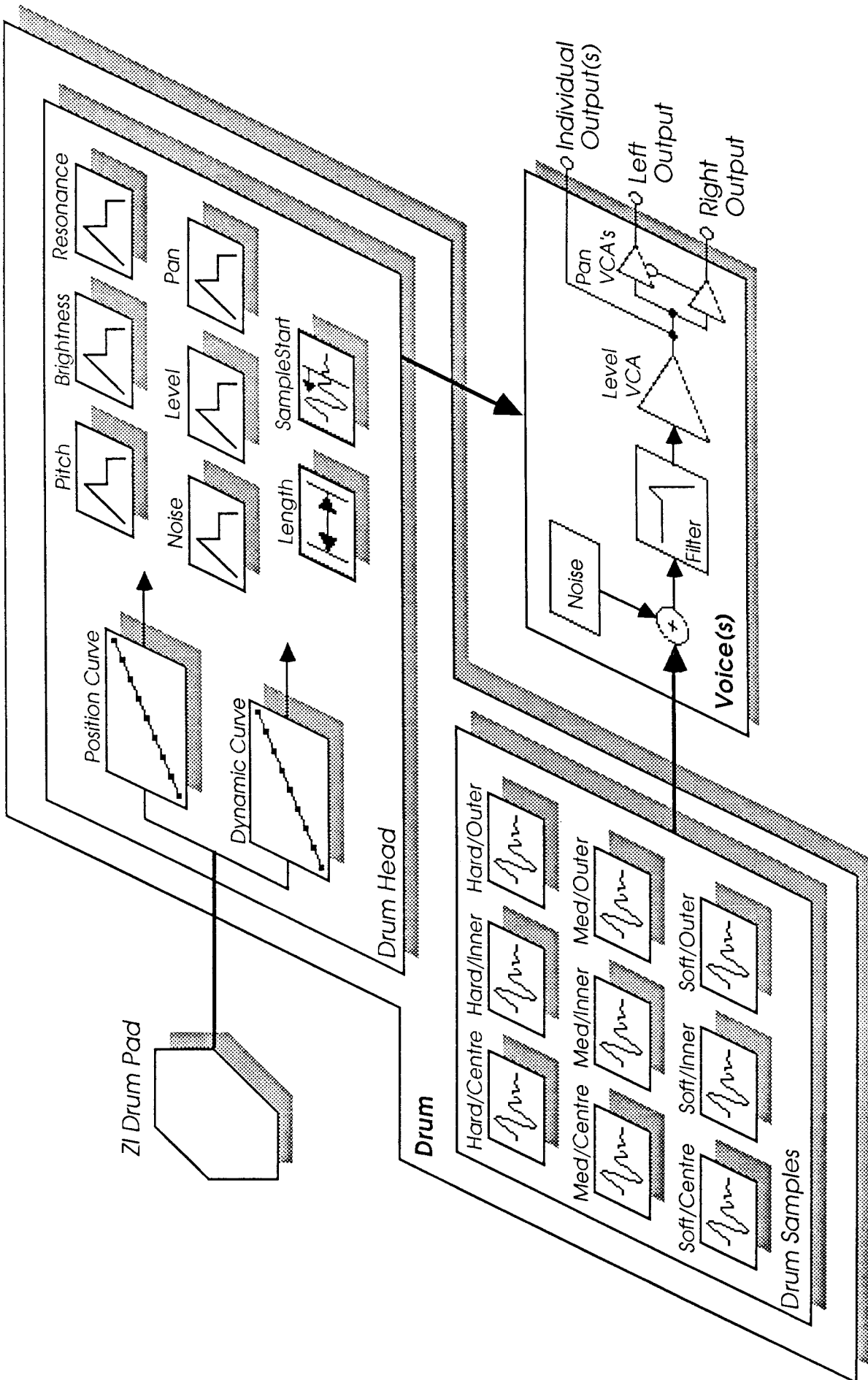

MAKING YOUR OWN DRUMS

By creating Multi-Sampled, Multi-Voiced Drums with Dynamic and Positional Drum Heads, SDX can produce the closest simulation of the acoustic instrument yet produced by electronic means.

In the Sound Disk Library you will find Drums which exploit all of these features. You can simply experiment with different combinations until you have constructed your ideal Kit, or you may wish to go further and make your own Drums by assigning your own Samples and constructing Drum Heads.

You may have noticed, when loading Drums into a Kit, that the **Kit/Drum Assigning Window** (click on the Pad's Drum Name to access) had two other choices that we didn't mention. These were **Sample Assign** and **Drum Head** which take you to the next level down allowing Drums to be Edited.

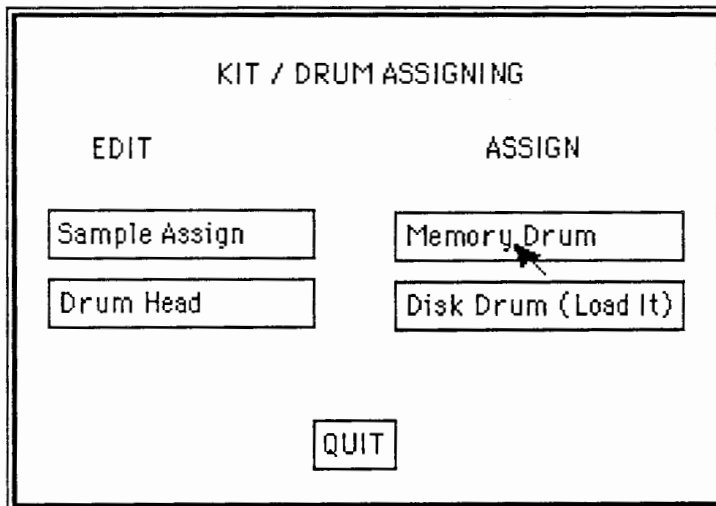

Sample Assign

Clicking on **Sample Assign** takes you to the **Sample Assign Screen**, allowing you to assign each of the Samples to Dynamic Level and Position. See **Using Sample Assign**.

Drum Head

Clicking on **Drum Head** takes you to the **Drum Head Screen**, allowing you to construct a Drum Head from the various Surfaces. See **Using Drum Head**.

4 - 31

The **Kit/Drum Assigning** Window now has another Edit option, **New Drum**.

This provides you with an easy way to create a New Drum. When you click this option a **Select Drum Type** Window will appear, allowing you to select the type of Drum you want to create.

When you select a Drum Type, **Drum Head** parameters suitable to that type of Drum, will be loaded and the Sample Assign Screen will be displayed with a Blank Drum. This saves you from having to set up Drum Head parameters, each time you create a New Drum. You can of course edit the Drum Head later, once you have created the Sample Assignment you want.

LEAVING THE KIT CONFIGURATION SCREEN

Once you have finished working with the Kit Configuration you can return to the Kit Select Screen by pointing to the **NEXT** box, holding the Select button to show the **Next Menu**, rolling the Tracker Ball down until the arrow is pointing to **Quit** and releasing the Select button.

If you have altered the Configuration of the active Kit, but have not saved it, a **Save Changes Window** is displayed, as described above, before you can leave the Screen.

SAVE CHANGES TO KIT ?

SAVE	Keep it
LOSE	Lose it forever
CONT	Continue with it

Save

If you wish to keep the recent changes, click on the **Save** box. The **Name Exists Window** will appear.

This window allows you to **Replace** the active Kit with the changes, **Rename** it to create another with the new Configuration, leaving the original intact, or **Quit** to cancel the Save operation and remain on the Kit Configuration Screen.

Lose

If you don't want to save any changes, click on the **Lose** box. This leaves the Configuration as it was when you loaded the Kit, losing any changes you made. The Kit Select Screen will now be displayed.

Cont

If you selected **Quit** from the **Next Menu** by mistake, or changed your mind about leaving the Kit Configuration Screen, you can cancel the Quit operation and continue, by clicking the **Cont** box.

Section 4.3

Using SDX: Drum Sample Assign Screen

CONTENTS

Selecting the Sample Assign Screen	4 - 33	Making your own Samples	4 - 48
Dynamic Levels	4 - 34	New Sample	4 - 48
Dynamic Level Meter	4 - 34	Edit Sample	4 - 48
Medium Threshold Handle	4 - 34		
Hard Threshold Handle	4 - 34		
Strike Position	4 - 34		
Current Dynamic/Position Marker	4 - 35		
Pitch Offset	4 - 35		
Level Offset	4 - 35		
Loading other Drums	4 - 35		
Loading Drums from Memory	4 - 36		
Loading Drums from Disk	4 - 37		
Assigning Samples	4 - 37		
Selecting other Samples from Memory	4 - 37		
Assigning Groups of Samples	4 - 39		
Special Assign Function	4 - 39		
Selecting Samples from Disk	4 - 39		
Assigning a different Sample to the Centre	4 - 40		
Saving your Changes	4 - 41		
Save Drum	4 - 41		
Save Drum As	4 - 41		
Leaving the Sample Assign Screen	4 - 42		
Save	4 - 42		
Lose	4 - 42		
Cont	4 - 42		
Bass, Rim and Pitched Sample Assigning	4 - 43		
Bass Drum Sample Assign	4 - 43		
Rim Sample Assign	4 - 44		
Pitched Drum Sample Assign	4 - 45		
Hi-Hat Sample Assigning	4 - 46		
Pedal Positions	4 - 46		
Pedal Position Indicator	4 - 46		
Sizzle Threshold Handle	4 - 47		
Open Threshold Handle	4 - 47		
Strike Position	4 - 47		
Pedal Trigger	4 - 47		
Assigning Samples	4 - 48		

Creative Use of SDX

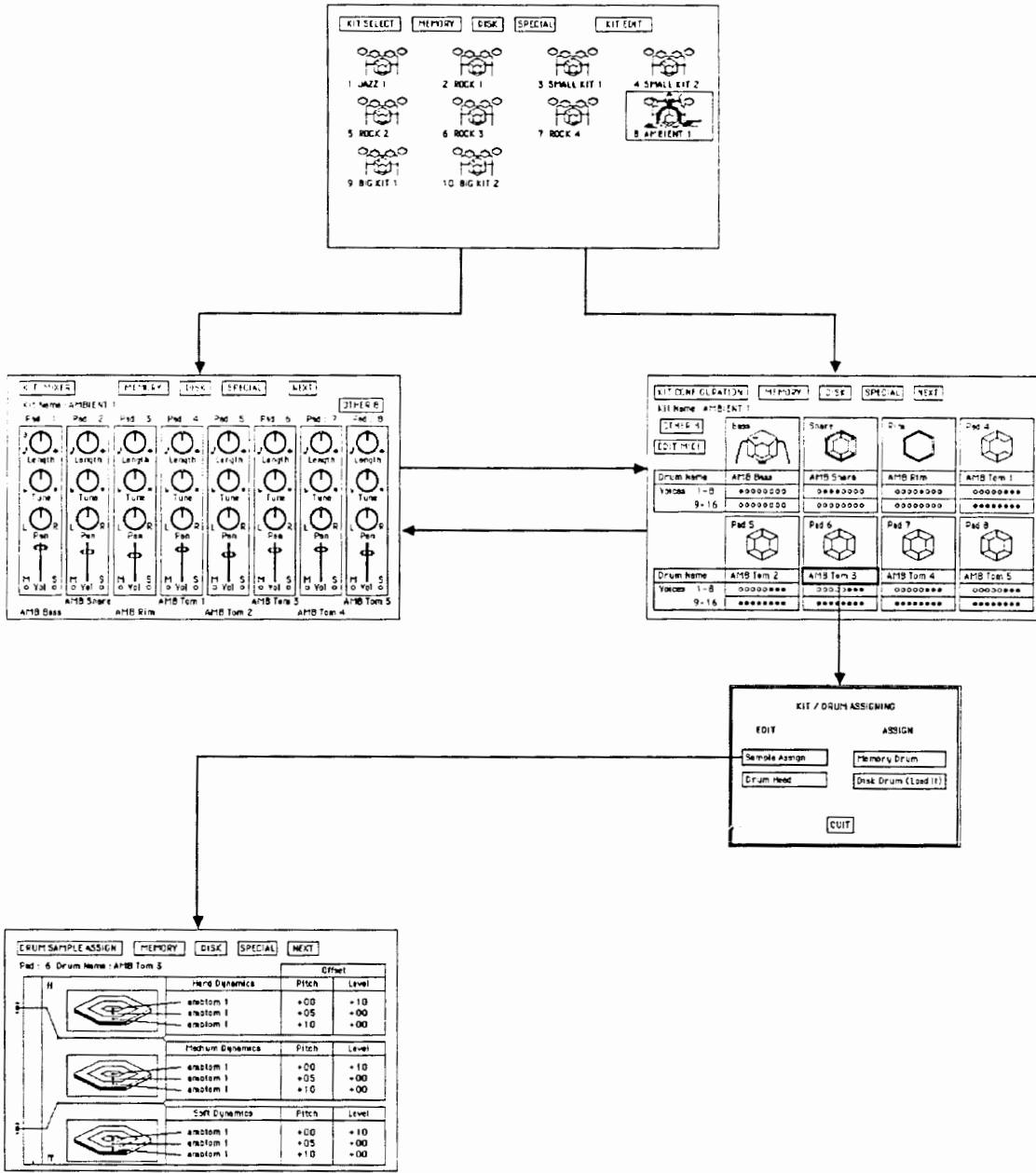

Using the **Kit Configuration** Screen you should now have an idea of how a Kit is constructed and have tried building your own Kits from the Drums supplied in the Sound Disk Library. The **Kit Configuration** section described how SDX allows you to define a Drum. If you have not read this section read 'What is a Drum?'.

The **Sample Assign Screen** allows you to edit **individual** Drums, by changing the Samples assigned to Dynamic Levels and Positions on the Pad. These Samples can be copied from other Drums in the Sound Disk Library or can be original Samples you have made yourself.

SELECTING THE SAMPLE ASSIGN SCREEN

The **Sample Assign Screen** is invoked from the Kit Configuration Screen by clicking on the Drum Name of the Drum you wish to edit and selecting **Sample Assign** from the **Kit/Drum Assigning** Window.

Let's look at how samples are assigned to the **Snare**.

From the **Kit Configuration Screen**, click on **Drum Name** for the Snare. The **Kit/Drum Assigning** Window appears. Now click the **Sample Assign** box. The **Sample Assign** Screen is displayed.

DRUM SAMPLE ASSIGN
MEMORY
DISK
SPECIAL
NEXT

Pad: 2 Drum Name : AMB Snare

		Offset	
ff	Hard Dynamics	Pitch	Level
	brassn1	+00	+00
	brassn1	+00	+00
	brassn1	+00	+00
Medium Dynamics	Medium Dynamics	Pitch	Level
	brassn1	+00	+00
	brassn1	+00	+00
	brassn1	+00	+00
PP	Soft Dynamics	Pitch	Level
	brassn1	+00	+00
	brassn1	+00	+00
	brassn1	+00	+00

This Screen shows the Sample Assignment of the Snare in the Active Kit.

Dynamic Levels

On the Screen there are 3 illustrations of a Drum Pad. These represent 3 Dynamic Levels to which Samples can be assigned.

- **Hard Dynamics**
- **Medium Dynamics**
- **Soft Dynamics**

Dynamic Level Meter

Try hitting the Snare Pad. You will see a line appear in the box on the far left, corresponding to the weight of the strike. This is called the **Dynamic Level Meter**.

There are two lines, which cross the Meter, that define the threshold points between the three Dynamic Levels.

- When the dynamic value of a hit is below the Soft/Medium Threshold, a **Soft Dynamic** Sample will be chosen.
- When the dynamic value of a hit is above the Soft/Medium Threshold but below the Medium/Hard Threshold, a **Medium Dynamic** Sample will be chosen.
- When the dynamic value of a hit is above the Medium/Hard Threshold, a **Hard Dynamic** Sample will be chosen.

Medium Threshold Handle

The Soft/Medium Threshold can be adjusted to suit your playing style by dragging the box at the end of the line, known as the **Medium Threshold Handle**, up or down. To do this, point to the box and while pressing the Select button, roll the Tracker Ball upwards to move the line up or downwards to move it down.

Hard Threshold Handle

The Medium/Hard Threshold can also be adjusted to suit your playing style by dragging its box, known as the **Hard Threshold Handle**, up or down. To do this, point to the box and while pressing the Select button, roll the Tracker Ball upwards to move the line up or downwards to move it down.

Strike Position

Each of the 3 Dynamic Levels is sub-divided into a further 3 sections, these represent the 3 Strike Positions to which Samples can be assigned.

- **Centre**
When the Pad is hit on the **Centre**, a centre Sample will be chosen.
- **Inner**
When the Pad is hit on the **Inner** ring, an inner Sample will be chosen.
- **Outer**
When the Pad is hit on the **Outer** ring, an outer Sample will be chosen.

Current Dynamic/Position Marker

Each time the Pad is hit a Cross appears next to one of the Sample names. This is called the **Dynamic/Position Marker** and indicates which of the Samples has been chosen, according to the Dynamic and Position of the Strike.

Try playing the Snare while watching the marker. Vary the Dynamic and Position of the hit, moving the marker between Samples.

Pitch Offset

Each Sample can have a Pitch Offset of plus or minus 12 Semitones. This allows the Pitch to be varied slightly up or down according to Dynamic and Position. For example you may wish to increase the Pitch slightly on the Outer ring to simulate the way in which a Drum Skin becomes tighter at the edge.

Place the Pointer on the Pitch Offset of the Sample you wish to change, then press and hold the Select button. A numeric box will appear allowing you to increase the Offset, by rolling the Tracker Ball upwards, or decrease it by rolling downwards.

Any value from -99 to +99 can be selected.

Double-Click on the value to reset it to zero.

Level Offset

Not in V1.2

Each Sample can also have a Level Offset of plus or minus 6 dB. This allows the Level to be varied slightly up or down according to Dynamic and Position. For example you may wish to increase the Level more dramatically in the Centre on a Hard Dynamic to create a very Loud Dynamic.

Place the Pointer on the Level Offset of the Sample you wish to change, then press and hold the Select button. A numeric box will appear allowing you to increase the Offset, by rolling the Tracker Ball upwards, or decrease it by rolling downwards.

Any value from -99 to +99 can be selected.

Double-Click on the value to reset it to zero.

LOADING OTHER DRUMS

Other Drums can be loaded into the Sample Assign Screen, allowing you to view or copy their Sample Assignments. Note that when a Drum is loaded the **Drum Head** for that Drum will also be loaded overwriting the current Drum Head.

Loading Drums from Memory

Select **Load Drum** from the **Memory** menu to load a Drum from those currently in Memory. If you have not saved recent changes to the Sample Assignment of the current Drum, a **Save Changes Window** will appear :

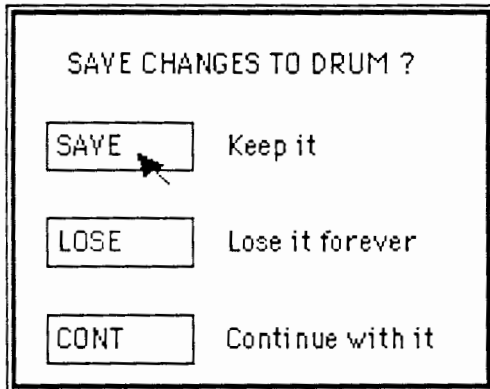

This gives you the option to **Save** any changes before loading the new Drum, **Lose** them leaving the Drum as it was before changes were made, or cancel the Load operation and **Continue** with the current Drum.

A **Load Memory Drum Catalog** will now be displayed unless you cancelled the operation from the Save Changes Window.

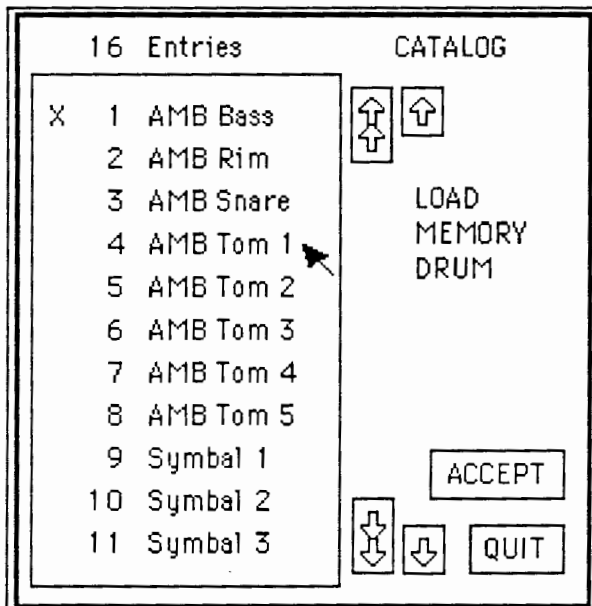

To select a Drum, click on it's Drum name. The Drum will indicated with a cross. Click **Accept** to load the Drum.

The selected Drum name will appear at the top of the Screen and it's Sample Assignment will be displayed. This is now the Active Drum.

Loading Drums from Disk

Drums can also be loaded from Disk by selecting **Load Drum** from the **Disk** menu. The selected Drum will be loaded into Memory and become Active. Only Samples which are not already in Memory will be loaded. If you have not saved recent changes to the Assignment, the **Save Changes Window** will open as described above.

A **Load Disk Drum Catalog** will now be displayed unless you cancelled the operation from the Save Changes Window.

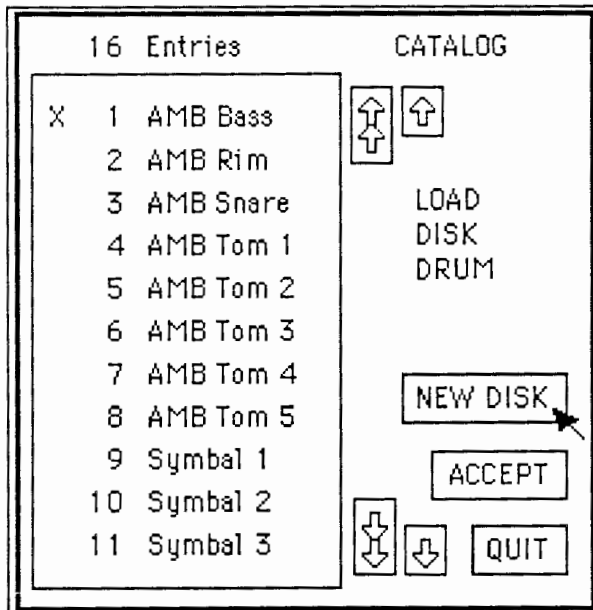

Select the Drum to be loaded from the Catalog and click **Accept** to load it.

The selected Drum name will appear at the top of the Screen and it's Sample Assignment will be displayed. This Drum is now Active.

ASSIGNING SAMPLES

When you loaded the Snare Drum, SDX automatically loaded the Samples for each Dynamic/Position along with the Threshold Points and Offsets required by that Drum.

Selecting Other Samples from Memory

You can change the **Samples** assigned to the Drum by replacing them with others from Memory or Disk. Place the Pointer on the **Sample Name** at the bottom of the Screen, the **Soft/Outer** Sample and Click. A **Drum/Sample Assigning** Window appears.

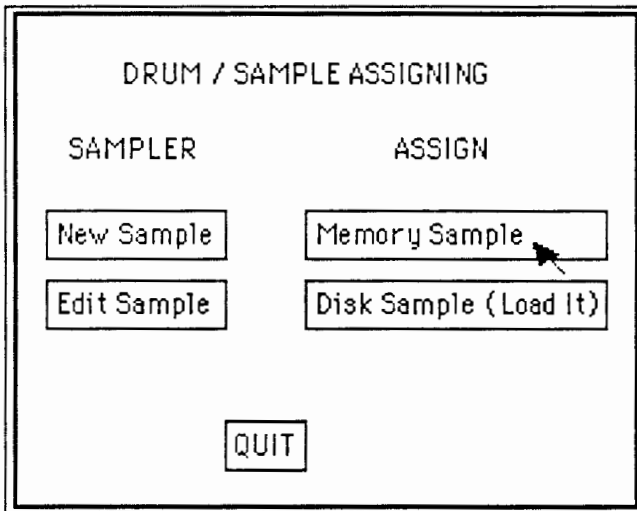

This window allows other Samples to be selected from Memory, by clicking **Memory Sample**, or loaded from Disk by clicking **Disk Sample**.

Click **Memory Sample**. The **Drum/Sample Assigning** Window is replaced by a **Load Memory Sample Catalog**.

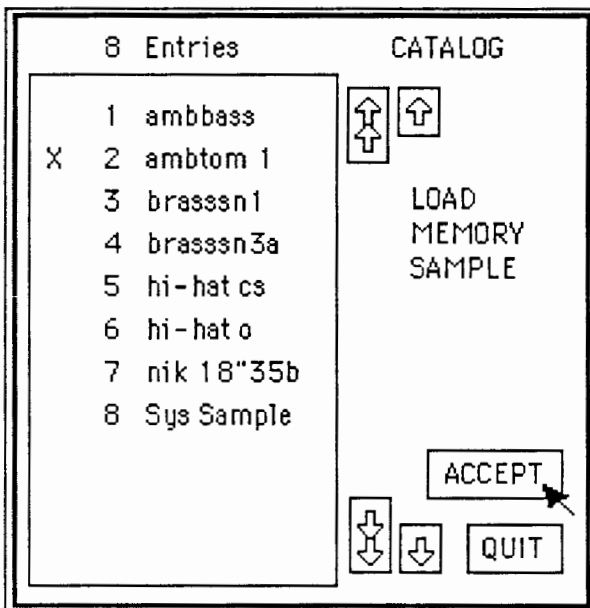

To select Sample, place the Pointer on the name of the Sample you require and click the Select Button. The entry will now be marked with a cross.

Click **Accept** to load this Sample. The Catalog Window will close and the new Sample name will now be displayed for all 9 Dynamic/Positions.

If you play the Snare now, the sound will have changed to that produced by the new Sample.

Note that it is **only** the Samples that have changed, the Snare still has the same **Drum Head** and the same Voice and MIDI assignments that it had on the **Kit Configuration** Screen.

Click on the Snare's Soft/Outer Name to open the **Drum/Sample Assigning** Window again and click **Memory Sample**. Select the original Snare Sample and click **Accept**. The original Sample Names are displayed again. Try playing the Snare Pad to check that the Snare sound has returned.

Assigning Groups of Samples

So far when we loaded a Sample it appeared in all of the 9 Dynamic/Position Sample Names. This is because all of the Samples were the same when we entered the Sample Assign Screen and the **Soft/Outer** Sample was used to open the **Drum/Sample Assigning** Window.

If each group of Samples **Soft**, **Medium** or **Hard** has the same Samples loaded you can quickly replace them as follows :

- **Select Soft/Outer**
To load the same Sample for all 9 Samples.
- **Select Medium/Outer**
To load the same Sample for all 6 medium and hard Samples.
- **Select Hard/Outer**
To load the same Sample for all 3 hard Samples.

Special Assign Function

If any of the Samples are different, you may not be able to use these group loads. However, you can make all the Samples the same using a **Special** function called **Set All**.

Point to the **SPECIAL** box and select **Set All as Soft/Outer** from the Special Menu. All the Dynamic/Position Sample names will change to the Soft/Outer Sample Name.

You can now use the group loads described above.

Selecting other Samples from Disk

Click on the **Hard/Outer** Sample Name to open the **Drum/Sample Assigning** Window, but this time click on **Disk Sample**.

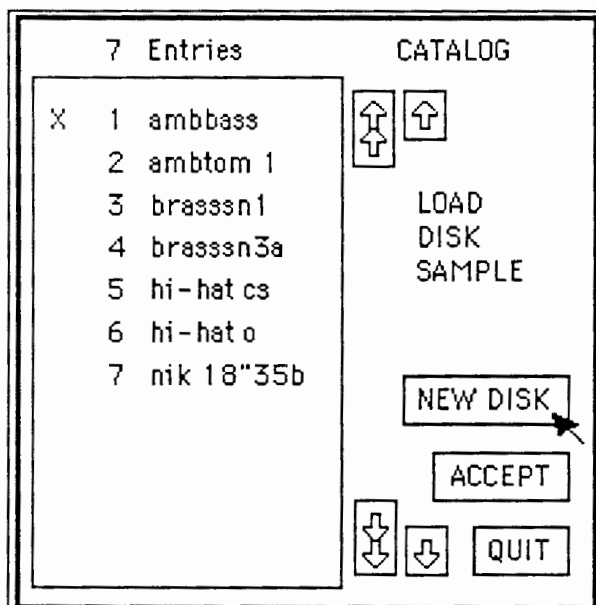

All the Samples which are currently on the Disk in the Drive are displayed in the Catalog. If you haven't changed Disks since you loaded the Kit, the Samples will be the same as the ones you have in your active Kit. Remove the Disk from the drive and replace it with another one of your Sound Disks. Now point to **New Disk** and click. The Catalog will now show all the Samples on the Disk you have just inserted. Choose the a Sample from the new entries and click **Accept**.

The Disk drive will become active and a **Loading Sample,...** **Please Wait** message will appear until the Sample is loaded. The **new** Sample Name now appears for the 3 Hard Samples.

Try playing the new Snare. For Soft and Medium hits it plays normally but when hit Hard the new Sample will be played.

Click on the **Hard/Outer** Sample Name to open the **Drum/Sample Assigning** Window again, and click on **Memory Sample**. You will see from the **Load Memory Sample** Catalog that the Sample you have just loaded has been added to those in Memory. Select the original Sample again and click **Accept**.

The previous Sample Names are displayed again. Try playing the Snare Pad to check that the Snare sound has returned for all Dynamic Levels.

Assigning a different Sample to the Centre

Let's try assigning a different Sample to the Centre of the Snare Pad.

- Click on the **Soft/Centre** Sample Name to open the **Drum/Sample Assigning** Window, and click on **Memory Sample**. Select a Sample from the **Load Memory Sample** Catalog and click **Accept**.
- Click on the **Medium/Centre** Sample Name to open the **Drum/Sample Assigning** Window again, and click **Memory Sample**. Select the **same** Sample from the **Load Memory Sample** Catalog again and click **Accept**.
- Click on the **Hard/Centre** Sample Name to open the **Drum/Sample Assigning** Window again, and click **Memory Sample**. Select the **same** Sample from the **Load Memory Sample** Catalog again and click **Accept**.

The Sample Names in the 3 Centre positions display the new Sample

Try playing the Snare Pad. Hits in the centre will play the new Sample at all Dynamic levels. Hits on the Inner and Outer rings sound like the original Snare.

Now select **Set All as Soft/Outer** from the **Special Menu** to assign all the Samples with the Soft/Outer Sample.

All the Sample Names have changed to the original Sample again. Try playing the Snare Pad to check that the Snare sound has returned for all Positions.

You can see how easy it is to customise the Drums supplied from your Sound Disks, constructing new unique Drums, simply by mixing the Sample assignments.

SAVING YOUR CHANGES

Once you have created a Drum you particularly like, you can save it to Memory - remember that all data will be lost when you power down - or save it to Disk, as a special Drum, or as part of a new Kit.

Save Drum

Selecting **Save Drum** from the **Memory** menu will save any changes made to the Sample Assignment as part of the Drum in Memory, replacing the previous Assignments. This will not effect the same Drum on your Disk. You should select **Save Drum** from the **Disk** menu if you wish to save the Assignment as part of the Drum on Disk.

Save Drum As

Selecting **Save Drum As** from the **Memory** menu will save the Assignment as a new Drum in Memory, leaving the previous one as it was. Selecting **Save Drum As** from the **Disk** menu will save any changes as a new Drum on Disk. The Disk must be Unprotected.

When **Save Drum As** is chosen, the **Alphanumeric Keyboard Window** opens, allowing the new Drum to be named.

To enter your new Drum name, using up to 11 characters, simply click on the letter or numbers in sequence. Upper case letters can be selected by clicking **Caps**. Click **Del** if you want to back-space or **Clear** to clear the entry. Common Drum names and the **Last Name** used are also available and are typed when clicked.

If you wish to cancel the **Save Drum As** operation, click **Quit**.

Click **Accept** when you are happy with the name. The new Drum will have the same Drum Head as before but will have the new Sample Assignment.

If the name you have chosen already exists, the **Name Exists Window** will open. This gives you the option to **Rename** the current Drum, using the Alphanumeric Keyboard again, **Replace** the Drum, overwriting it with the same name, or **Quit** the **Save Drum As** operation.

LEAVING THE SAMPLE ASSIGN SCREEN

Once you have finished working with the current Drum you can return to the Kit Configuration Screen by selecting **Quit** from the **Next Menu**.

If you have altered the Sample Assignment of the Drum, but have not saved it, a **Save Changes Window** is displayed, before you can leave the Screen.

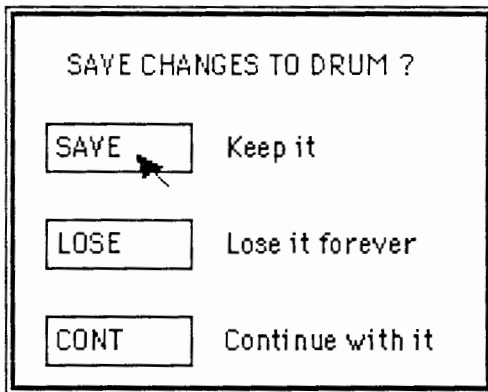

Save

If you wish to keep the recent changes, click on the **Save** box. The **Name Exists Window** will open.

This window allows you to **Replace** the current Drum with the changes, **Rename** it to create another with the new Assignment, leaving the original intact, or **Quit** to cancel the Save operation and remain on the Sample Assign Screen.

Lose

If you don't want to save any changes, click on the **Lose** box. This leaves the Assignment as it was when you loaded the Drum, losing any changes you made. The Kit Configuration Screen will now be displayed.

Cont

If you selected **Quit** from the **Next Menu** by mistake, or changed your mind about leaving the Sample Assign Screen, you can cancel the Quit operation and continue, by clicking the **Cont** box.

BASS, RIM AND PITCHED SAMPLE ASSIGNING

Samples for the **Tom** and **Symbal** Pads are assigned in the same way as described for the Snare. However, **Bass**, **Rim**, **Pitched** and **Hi-Hat**, are different from the others as they don't produce positional information and therefore cannot have position Samples



Bass Drum Sample Assign

Click on the **Bass** Drum Name and select **Sample Assign** from the **Kit/Drum Assigning** Window.

The **Sample Assign** Screen for the Bass Drum is displayed.

DRUM SAMPLE ASSIGN
MEMORY
DISK
SPECIAL
NEXT

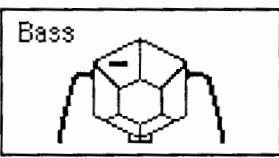
Pad : 1 Drum Name : AMB Bass

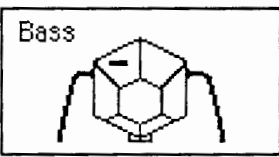
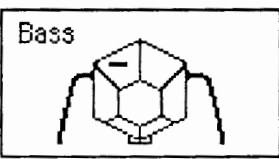
		Offset	
ff	Bass 	Hard Dynamics	Pitch
	ambbass 	+00	+00
	Bass 	Medium Dynamics	Pitch
	ambbass	+00	+00
pp	Bass 	Soft Dynamics	Pitch
	ambbass	+00	+00

Obviously there are no Position Samples, since the Beater of the Bass Pedal can only strike the Centre of the Drum. However, the 3 Dynamic Samples, Thresholds and Offsets can all be assigned in the same way as the Snare Drum.

Other Drums can be Loaded or Saved using the **Memory** and **Disk** Menus as described for the Snare.

To leave the **Bass Sample Assign** Window, save any changes then select **Quit** from the **Next Menu**.

Creative Use of SDX

Rim Sample Assign

Click on the **Rim** Drum Name and select **Sample Assign** from the **Kit/Drum Assigning** Window.

The **Sample Assign** Screen for the Rim is displayed.

DRUM SAMPLE ASSIGN MEMORY DISK SPECIAL NEXT

Pad : 3 Drum Name : AMB Rim

		Offset	
		Pitch	Level
ff	Rim		
	brassn3a	+00	+00
	Rim		
	brassn3a	+00	+00
	Rim		
pp	Rim		
	brassn3a	+00	+00

There are no Position Samples, since the Rim has only one Position - the edge of the Snare Drum. However, the 3 Dynamic Samples, Thresholds and Offsets can all be assigned in the same way as the Snare Drum.

Other Drums can be Loaded or Saved using the **Memory** and **Disk** Menus as described for the Snare.

To leave the **Rim Sample Assign** Window, save any changes then select **Quit** from the **Next Menu**.



Pitched Drum Sample Assign

Click any Drum Name with a **Pitched** icon and select **Sample Assign** from the **Kit/Drum Assigning** Window.

The **Sample Assign** Screen for a Pitched Drum is displayed.

DRUM SAMPLE ASSIGN
MEMORY
DISK
SPECIAL
NEXT

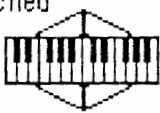
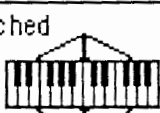
Pad : 12 Drum Name : Choir

		Offset	
ff	Pitched 	Hard Dynamics	Pitch
			Level
	Vocal 3	+00	+00
	Pitched 	Medium Dynamics	Pitch
			Level
	Vocal 3	+00	+00
pp	Pitched 	Soft Dynamics	Pitch
			Level
	Vocal 3	+00	+00

Pitched Drums are those which would normally be played by an external MIDI Instrument, connected to MIDI In. MIDI Keyboards normally transmit Note events with Dynamics. SDX uses the Dynamic information to select one of the 3 Dynamic Samples and the Note information to Pitch the Sample. Therefore there are no Position Samples.

Dynamic Samples, Thresholds and Offsets can all be assigned in the same way as the Snare Drum.

Other Drums can be Loaded or Saved using the **Memory** and **Disk** Menus as described for the Snare.

To leave the **Pitched Sample Assign** Window, save any changes then select **Quit** from the **Next Menu**.

HI-HAT SAMPLE ASSIGNING

Click on the **Hi-Hat** Drum Name and select **Sample Assign** from the **Kit/Drum Assigning** Window.

The **Sample Assign** Screen for the Hi-Hat is displayed.

		Offset	
		Pitch	Level
Open			
hihat open		+00	+00
hihat open		+00	+00
Sizzle			
hihat sizz		+00	+00
hihat sizz		+00	+00
Closed			
hihat clos		+00	+00
hihat clos		+00	+00
Pedal Trigger			
hihat ped		+00	+00

The Hi-Hat Sample Assign Screen is different from all the other Sample Assign Screens because it does not use Dynamic information from the Hi-Hat Pad. Instead, it uses the Pedal position to select between 3 groups of Samples or trigger a separate Sample. The Hi-Hat will still be Dynamic when you play it, you just can't assign Samples to each level.

Pedal Positions

On the Screen there are illustrations of 3 Hi-Hats and a Pedal. These represent 4 Hi-Hat states to which Samples can be assigned.

- Hi-Hat Open
- Hi-Hat Sizzle
- Hi-Hat Closed
- Pedal Trigger

Pedal Position Indicator

Try pressing the Hi-Hat Pedal. You will see an indicator move in the box on the far left, corresponding to the position of the Pedal. This is called the **Pedal Position Indicator**.

There are two lines, which cross the box, that define the Threshold points between the Hi-Hat states.

- When the Pedal position is above the Open/Sizzle Threshold, an **Open** Sample will be chosen.
- When the Pedal position is below the Open/Sizzle Threshold but above the Sizzle/Closed Threshold, a **Sizzle** Sample will be chosen.
- When the Pedal position is below the Sizzle/Closed Threshold, a **Closed** Sample will be chosen.

Sizzle Threshold Handle

The Sizzle/Closed Threshold can be adjusted to suit your playing style by dragging the box at the end of it's line, known as the **Sizzle Threshold Handle**, up or down. To do this, point to the box and while pressing the Select button, roll the Tracker Ball upwards to move the line up or downwards to move it down.

Open Threshold Handle

The Open/Sizzle Threshold can also be adjusted to suit your playing style by dragging it's box, known as the **Open Threshold Handle**, up or down. To do this, point to the box and while pressing the Select button, roll the Tracker Ball upwards to move the line up or downwards to move it down.

Strike Position

Each of the 3 Hi-Hat states is sub-divided into a further 2 sections, these represent 2 Strike Positions to which Samples can be assigned.

- **Centre**
When the Pad is hit on the **Centre**, a centre Sample will be chosen.
- **Outer**
When the Pad is hit on the **Outer** ring, an outer Sample will be chosen.

Pedal Trigger

A fourth state on the Screen allows a different Sample to be chosen when the Pedal passes a **Trigger Threshold**. This is selected by dragging it's arrow up or down. To do this, point to the arrow and while pressing the Select button, roll the Tracker Ball upwards to move the line up or downwards to move it down.

4 - 46

A **Minimum Dynamic** has been added to the Hi-Hat's Sample Assign Screen. This effects the level produced by the Pedal Trigger, ranging from 1 to 127. The default value is 95.

Assigning Samples

The 7 Hi-Hat Samples, Thresholds and Offsets can all be assigned in the same way as the Snare Drum.

Other Drums can be Loaded or Saved using the **Memory** and **Disk** Menus as described previously.

To leave the **Hi-Hat Sample Assign** Window, save any changes then select **Quit** from the **Next Menu**.

MAKING YOUR OWN SAMPLES

In the Sound Disk Library you will find Drums which are made up from a number of different Samples. You can simply experiment with different Sample Assignments until you have constructed your ideal Drum, or you may wish to go further and make your own Samples, by copying and editing those in the Sound Library, or Sampling new ones from the Audio input.

You probably noticed, when loading Samples into a Drum, that the **Drum/Sample Assigning** Window (click on the Drum's Sample Name to open) had two other choices. These were the **New Sample** and **Edit Sample** which take you to the next level down, allowing new Samples to be created or old ones Edited.

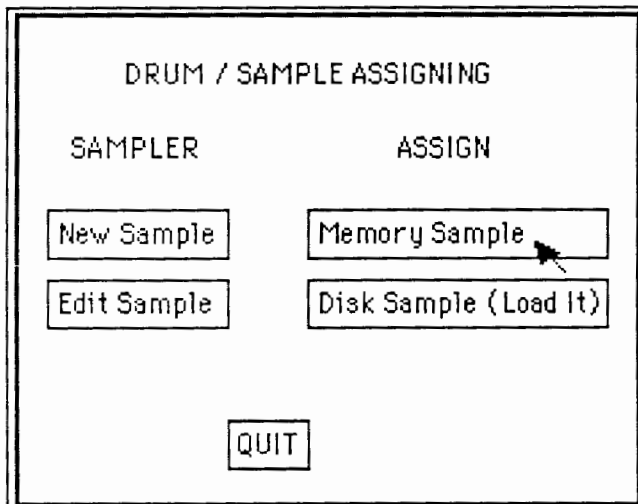

New Sample

Clicking on **New Sample** takes you to the **Sampler Screen**, allowing you to create a new Sample by Sampling the Audio Input. See **Using the Sampler**.

Edit Sample

Clicking on **Edit Sample** also takes you to the **Sampler Screen**, but allows Samples from Memory or Disk to be viewed and Edited. See **Using the Sampler**.

Section 4.4

Using SDX: Drum Head Screen

CONTENTS

What is a Drum Head ?	4 - 49	Length Surface	4 - 70
Dynamic Curve	4 - 50	SampleStart Surface	4 - 71
Position Curve	4 - 50	Moving to the Sample Assign Screen	4 - 72
Pitch Surface	4 - 50	Saving your Changes	4 - 72
Brightness Surface	4 - 50	Save Drum	4 - 72
Resonance Surface	4 - 50	Save Drum As	4 - 72
Noise Surface	4 - 51	Leaving the Drum Head Screen	4 - 73
Level Surface	4 - 51	Save	4 - 73
Pan Surface	4 - 51	Lose	4 - 74
Length Surface	4 - 51	Cont	4 - 74
SampleStart	4 - 51		
Selecting the Drum Head Screen	4 - 52		
Surface Stack	4 - 52		
Surface Number	4 - 52		
Surface Type	4 - 53		
Surface Range	4 - 53		
Dynamic Curve	4 - 53		
Position Curve	4 - 53		
Loading other Drums	4 - 54		
Loading Drums from Memory	4 - 54		
Loading Drums from Disk	4 - 55		
What is a Surface ?	4 - 56		
Opening A Surface Window	4 - 61		
Envelopes	4 - 62		
Envelope Shape	4 - 62		
Preset Envelope Shapes	4 - 62		
Flip Envelope	4 - 62		
Other Envelopes	4 - 62		
Copying Envelope Shapes	4 - 63		
Closing the Surface Window	4 - 63		
Adding an New Surface	4 - 63		
Adding an Initial Surface	4 - 63		
Adding an Envelope Surface	4 - 63		
Adjusting the Surface Range	4 - 64		
Pitch Surfaces	4 - 64		
Brightness Surfaces	4 - 65		
Resonance Surfaces	4 - 66		
Noise Surfaces	4 - 67		
Level Surfaces	4 - 68		
Pan Surfaces	4 - 69		

DRUM HEAD SCREEN

Using the **Sample Assign** Screen you should have tried creating new Drums by re-arranging the Samples supplied in the Sound Disk Library. However, this only defines **what** is played when a Pad is struck. **How** the Sample is played, is defined by the **Drum Head**. If you have not already done so, read the **Kit Configuration** section 'What is a Drum ?'.

The **Drum Head Screen** allows you to construct a **Drum Head**, for each **individual** Drum, from a number of **Surfaces**. Each Surface controls a parameter within the Voice, according to the Dynamic and Position of the Pad strike.

The 'Feel' or response of each Drum Pad can also be adjusted to your own playing style by shaping it's **Dynamic** and **Position Curves**. Drum Heads can be copied and edited from other Drums in the Sound Disk Library or can be constructed from scratch.

WHAT IS A DRUM HEAD?

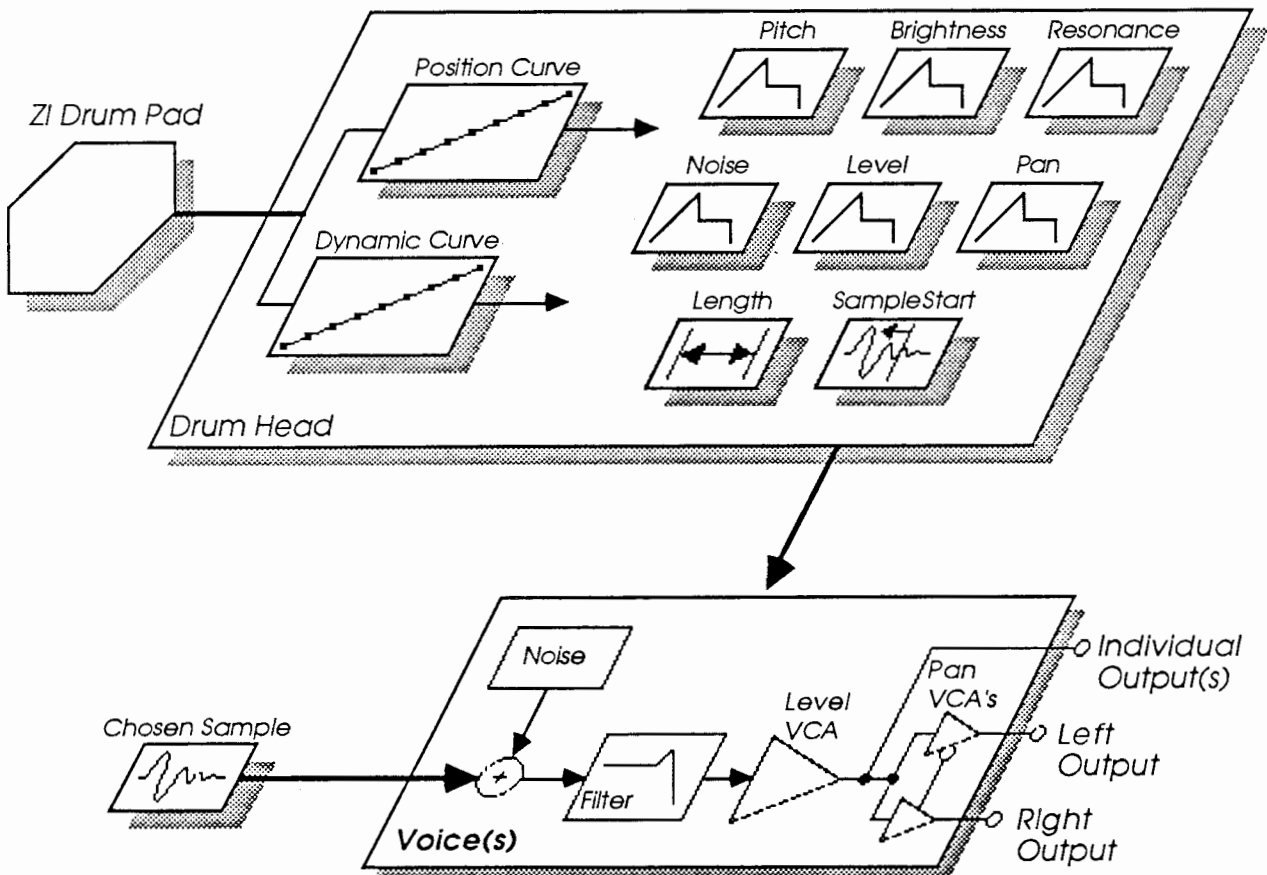

From the illustration you can see that a Drum Head is constructed from two Curves, which define the Dynamic and Positional effects of a Pad hit, and a number of Surfaces. Each Surface controls a parameter within the Drum's Voice and can respond to the values produced by the Dynamic and Position Curves.

Dynamic Curve

The Dynamic Curve defines the relationship between the **Weight** of the strike on the Drum Pad and the amount of **Dynamic** effect produced. The default is a straight line, or one-to-one relationship. This means that for Soft hits you get the minimum Dynamic effect, Medium hits produce a medium Dynamic effect and Hard hits give the maximum Dynamic effect. You can, however, alter this relationship by shaping the curve to suit your own playing style, adjusting the Feel of the Drum.

Position Curve

The Position Curve defines the relationship between the **Position** of the strike on the Drum Pad and the amount of **Positional** effect produced. The default is a straight line, or one-to-one relationship. This means that for a hit in the Outer ring you get the minimum Positional effect, a hit on the inner ring produces medium Positional effect and a hit on the Centre gives the maximum Positional effect. You can, however, alter this relationship by shaping the curve to suit your playing style.

Pitch Surface

A Pitch Surface allows the Pitch or Playback rate of the chosen Sample to be controlled. The Initial Pitch Surface can be adjusted to be above or below the rate the Sample was recorded at. In addition, the Pitch Envelope Surface allows the Pitch of the Sample to be altered in real-time, according to the Shape of its 5 point Envelope.

Brightness Surface

A Brightness Surface allows the Filter's Cut-Off Frequency to be controlled. The Initial Brightness Surface can be adjusted to be above or below a pre-set Cut-Off point. In addition, the Brightness Envelope Surface allows the Brightness of the Filter to be altered in real-time, according to the Shape of its 5 point Envelope.

Resonance Surface

A Resonance Surface allows the Filter's Resonance to be controlled. The Initial Resonance Surface can be adjusted to be above or below a pre-set Resonance value. In addition, the Resonance Envelope Surface allows the Resonance of the Filter to be altered in real-time, according to the Shape of its 5 point Envelope.

Noise Surface

A Noise Surface allows the balance between the chosen Sample and a Noise Source to be controlled. The Noise Envelope Surface allows the Noise to Sample mix to be altered in real-time, according to the Shape of it's 5 point Envelope.

Level Surface

A Level Surface allows the Volume the filtered Sample to be controlled. The Level Envelope Surface is always part of the Head and allows the Volume of the Sample to be altered in real-time, according to the Shape of it's 5 point Envelope.

Pan Surface

A Pan Surface allows the Stereo Position of the Drum to be controlled. The Initial Pan Surface can be adjusted to be left or right of Centre. In addition, the Pan Envelope Surface allows the Panning of the Drum to be altered in real-time, according to the Shape of it's 5 point Envelope.

Length Surface

The Length Surface allows the Duration of all the Surface Envelopes to be controlled. It can be adjusted to be shorter or longer than a pre-set Duration.

SampleStart

The SampleStart Surface allows the Start point of the Sample to be altered. It can be adjusted to be any point between the beginning and the end of the Sample. The Surface can only be effected by values produced from the Dynamic Curve.

SELECTING THE DRUM HEAD SCREEN

The **Drum Head Screen** is invoked from the Kit Configuration Screen by clicking on the Drum Name of the Drum you wish to edit and selecting **Drum Head** from the **Kit/Drum Assigning Window**.

Let's look at how a Drum Head is constructed for the **Snare**.

From the **Kit Configuration Screen**, click on **Drum Name** for the Snare. The **Kit/Drum Assigning Window** appears. Now click the **Drum Head** box. The **Drum Head Screen** is displayed.

DRUM HEAD
MEMORY
DISK
SURFACES
NEXT

Pad : 2 Drum Name : AMB Snare

Surface Stack

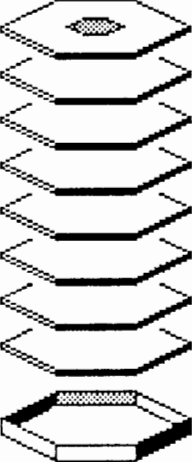

↑	Surface Type	Range
1	Level Env	+999
2	Pitch Env	+050
3	Brightness Env	+250
4	Sample Start	+100
↓		

Dynamic Curve



Soft
Hard

Position Curve

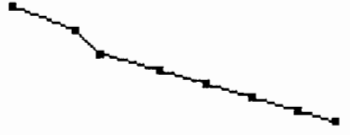

Centre
Edge

This Screen shows the Drum Head of the Snare in the active Kit.

Surface Stack

On the Screen there is an illustration of several Surfaces within an exploded Drum Pad. This **Surface Stack** graphically represents the Surfaces which are 'bonded' together to make a Drum Head.

Surface Number

The numbers of the Surfaces which make up the Head are displayed in the first column. If the Drum Head is made from more than 8 Surfaces you can view the others by clicking on the up or down **Scroll** arrows.

Surface Type

The Surface Type column shows the **Surfaces** which make up the Snare's Drum Head. Only **Surfaces** which are **Active** are displayed.

This Snare has the following Surfaces :

- **Level Env**
Opens the Level VCA to let the Sample through.
- **Pitch Env**
Bends the Pitch.
- **Brightness Env**
Sweeps the Filter.
- **SampleStart**
Adjusts the Start point of the Sample.

Surface Range

All of the Active Surfaces have a **Range** displayed. You can increase or decrease the Range of any Surface to give it more or less effect.

Place the Pointer on the Range of a Surface you wish to change, then press and hold the Select Button. A numeric box will appear allowing you to increase the Range, by rolling the Tracker Ball upwards, or decrease it by rolling downwards.

Double-Click on the value to reset it to zero.

Dynamic Curve

This Curve defines the relationship between the **Weight** of the strike on the Snare Pad and the amount of **Dynamic** effect produced. To change it's shape, point to any of the 9 boxes, press the Select Button and drag the box up or down using the Tracker Ball.

Double-Click anywhere in the Curve window to reset the Curve to a straight line.

Position Curve

This Curve defines the relationship between the **Position** of the strike on the Snare Pad and the amount of **Positional** effect produced. To change it's shape, point to any of the 9 boxes, press the Select Button and drag the box up or down using the Tracker Ball.

Double-Click anywhere in the Curve window to reset the Curve to a straight line.

LOADING OTHER DRUMS

Other Drums can be loaded into the Drum Head Screen, allowing you view or edit their Drum Heads. Note that when a Drum is loaded the Sample Assignment for that Drum will also be loaded overwriting the current Sample Assignment.

Loading Drums from Memory

Select **Load Drum** from the **Memory** menu to load a Drum from those currently in Memory. If you have not saved recent changes to the Drum Head of the current Drum, a **Save Changes Window** will appear :

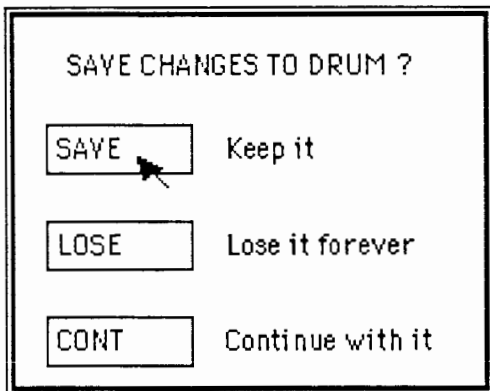

This gives you the option to **Save** any changes before loading the new Drum, **Lose** them leaving the Drum as it was before changes were made, or cancel the Load operation and **Continue** with the current Drum.

A **Load Memory Drum Catalog** will now be displayed unless you cancelled the operation from the Save Changes Window.

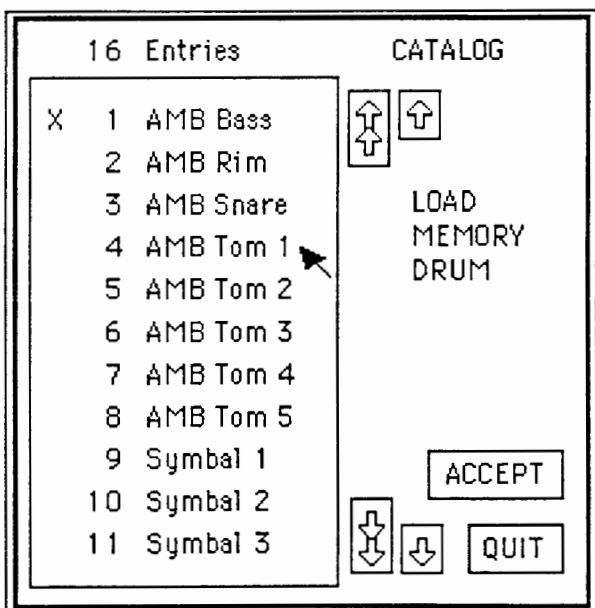

To select a Drum, click on it's Drum name. The Drum will indicated with a cross. Click **Accept** to load the Drum.

The selected Drum name will appear at the top of the Screen and it's Drum Head Surfaces will be displayed. This is now the current Drum.

Loading Drums from Disk

Drums can also be loaded from Disk by selecting **Load Drum** from the **Disk** menu. The selected Drum will be loaded into Memory and become current. If you have not saved recent changes to the Drum Head, the **Save Changes Window** will open as described above.

A **Load Disk Drum Catalog** will now be displayed unless you cancelled the operation from the Save Changes Window.

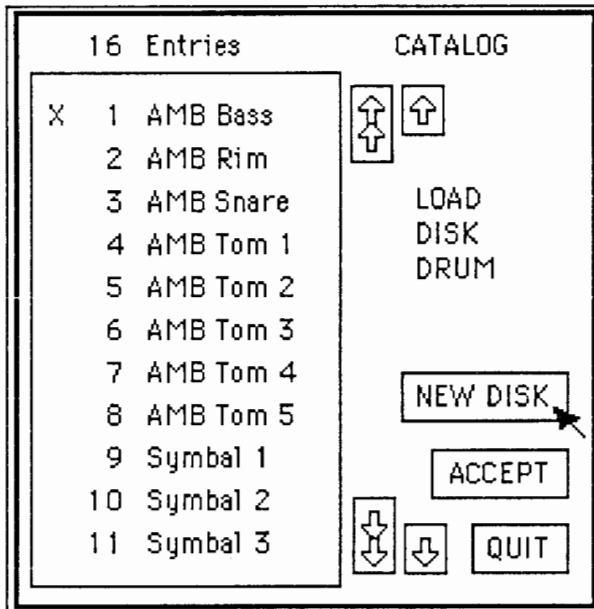

Select the Drum to be loaded from the Catalog and click **Accept** to load it.

The selected Drum name will appear at the top of the Screen and it's Active Surfaces will be displayed. This Drum is now current.

WHAT IS A SURFACE ?

Imagine a Surface in 3D with a **Dynamic** axis, a **Position** axis and an **Effect** axis.

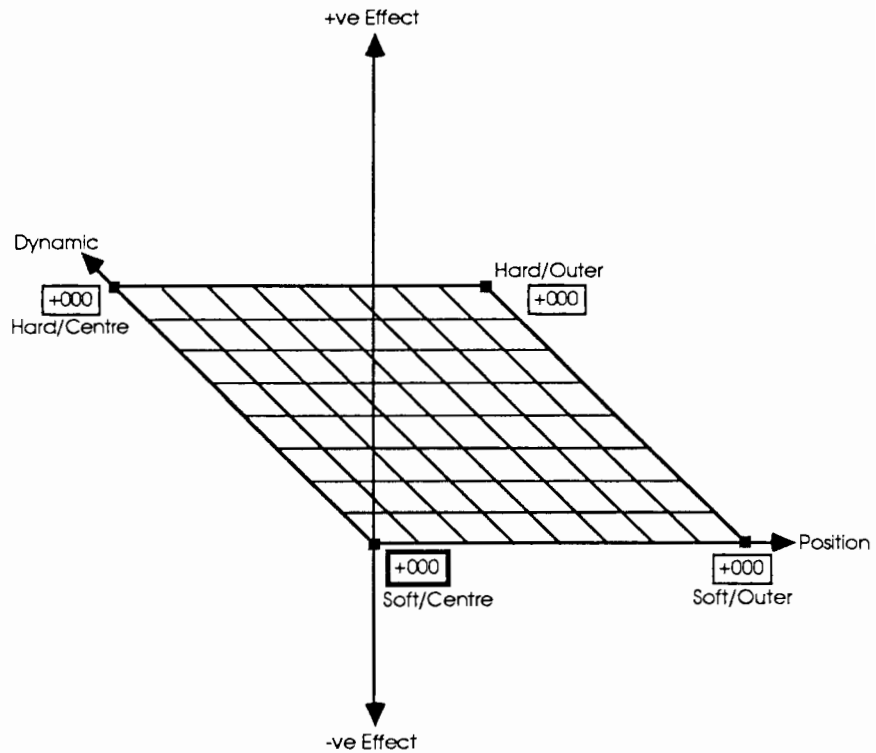

When the **Weight** of a hit increases from **Soft** to **Hard** the Dynamic value produced moves along the **Dynamic** axis. When the **Position** of a hit moves from **Centre** to **Outer** the Position value produced moves along the **Position** axis. Since both of these values are generated simultaneously by the action of a stick hitting the Pad, all combinations of the Dynamic and Position values can be defined by the shaded **Surface**.

The vertical axis determines how much **Effect** is produced as the Dynamic and Position values change. Since, in this case, all four **co-ordinates** are zero, there is no Effect produced by any Dynamic or Position values. This Surface is therefore **Inactive**.

The **Soft/Centre** co-ordinate has a double box around it. This is because it alters the **Range** of the Surface. The other three co-ordinates are always **referenced** to the this value.

If we **increase** the Soft/Centre value the Surface will move upwards causing a positive Effect.

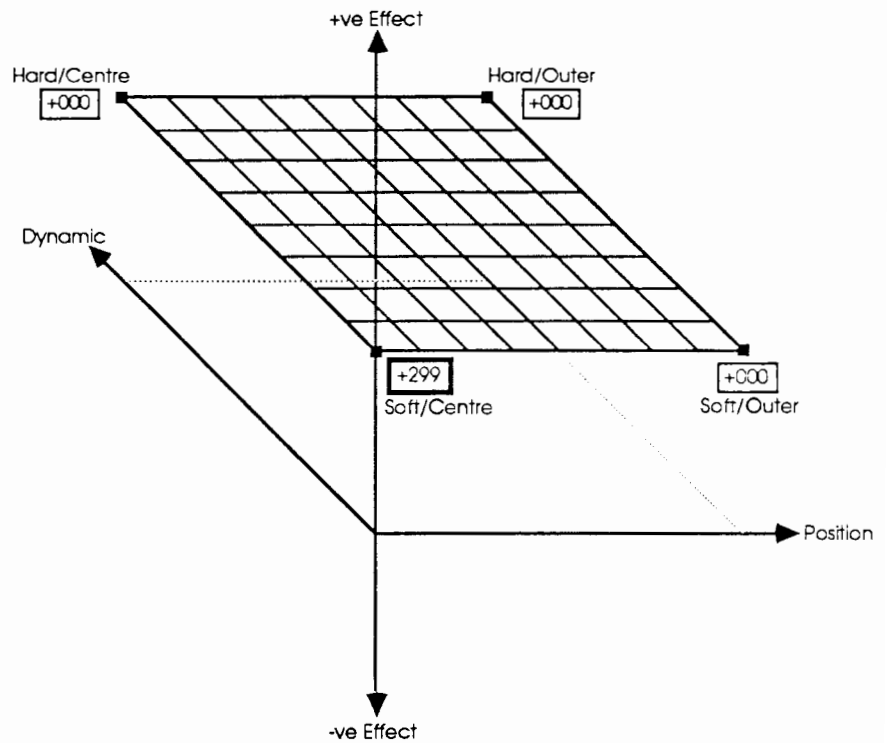

The Surface remains flat, since the other co-ordinates are still zero, but it now produces an Effect and is therefore **Active**.

If we **decrease** the Soft/Centre value the Surface will move downwards causing a negative Effect.

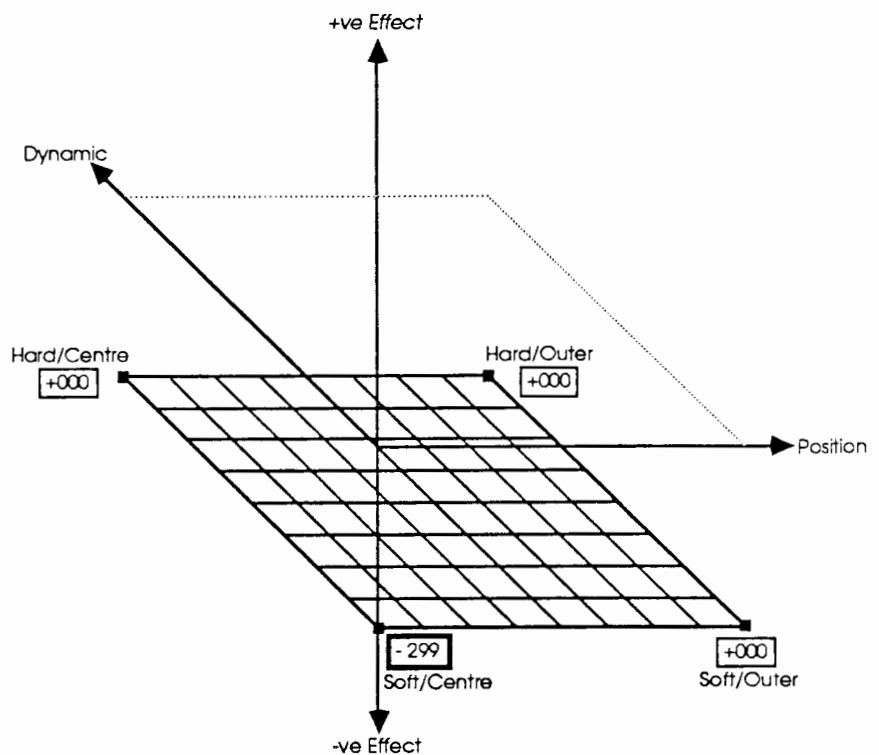

The Surface remains flat, since the other co-ordinates are still zero, but again it produces an Effect and is therefore **Active**. However, there is no change in the Effect for a change in Dynamic or Position values.

So far so good. Now let's tilt the Surface by setting the Soft/Centre back to zero, but increasing the **Hard/Centre** and **Hard/Outer** co-ordinates.

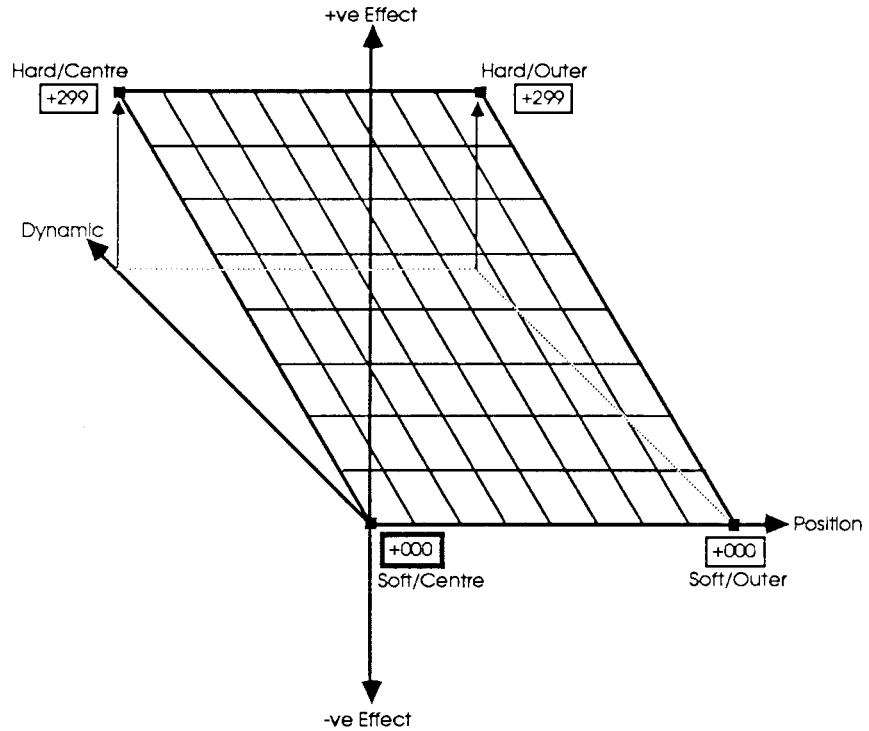

We have now produced an Active Surface which increases in Effect with a change in Dynamic, but produces no Effect for a change in Position.

We can tilt the Surface the other way by setting the **Hard/Centre** back to zero and increasing the **Soft/Outer** co-ordinate.

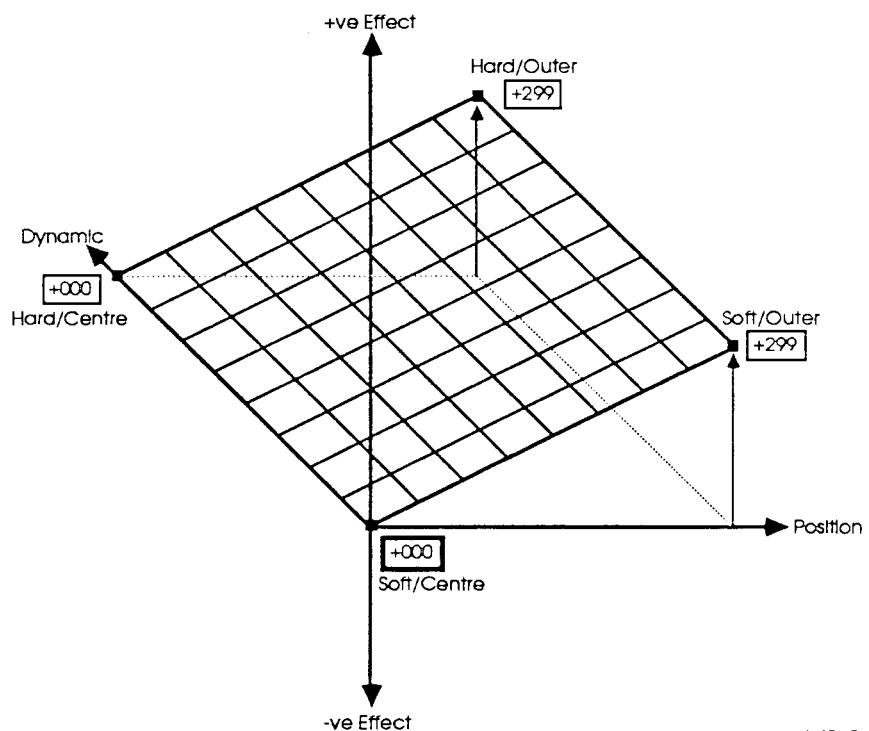

We have now produced an Active Surface which increases in Effect with a change in Position, but produces no Effect for a change in Dynamic.

To combine the Effect of Dynamic and Position twist the Surface by setting the **Soft/Outer** and **Hard/Outer** back to zero and increasing only the **Hard/Centre** co-ordinate.

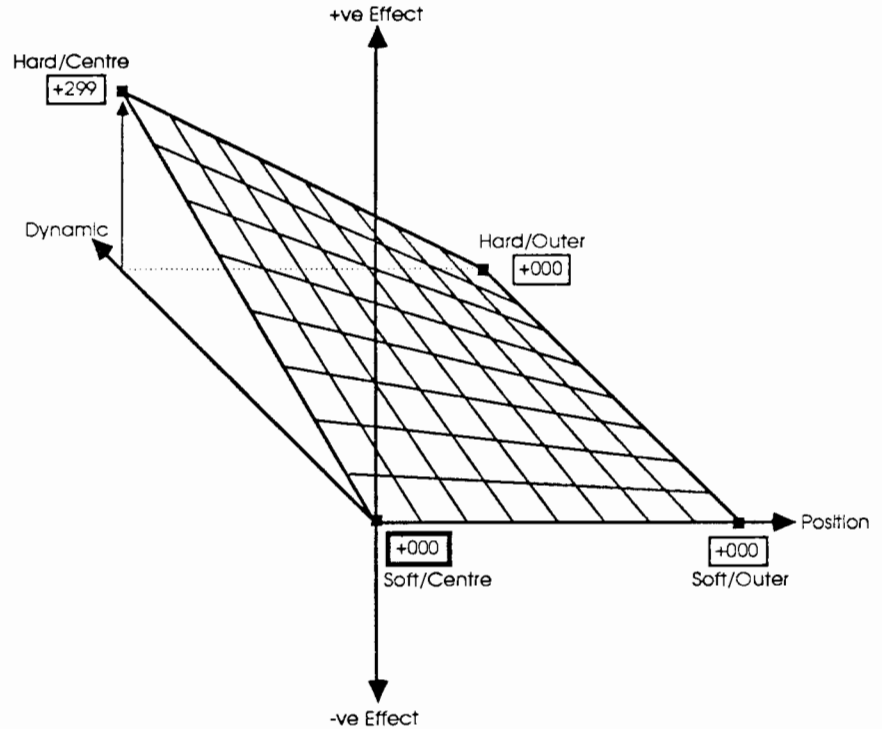

This Active Surface has maximum Effect with Hard hits in the Centre of the Pad, decreasing to zero with Softer hits and with movement towards the Outer edge of the Pad.

To reverse the Positional Effect, twist the Surface another way by setting the **Hard/Centre** back to zero and increase only the **Hard/Outer** co-ordinate.

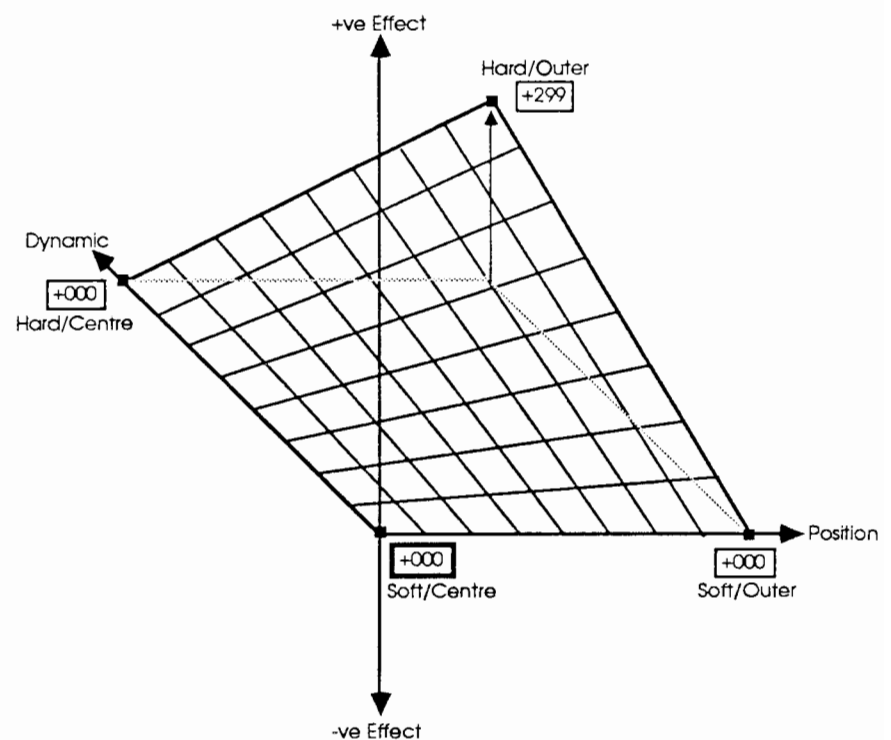

This Active Surface has maximum Effect with Hard hits on the Outer edge of the Pad, decreasing to zero with softer hits and with movement towards the Centre of the Pad.

The Surface can also be twisted to produce both positive and negative Effects. Increase the **Hard/Centre** co-ordinate and decrease the **Hard/Outer** co-ordinate.

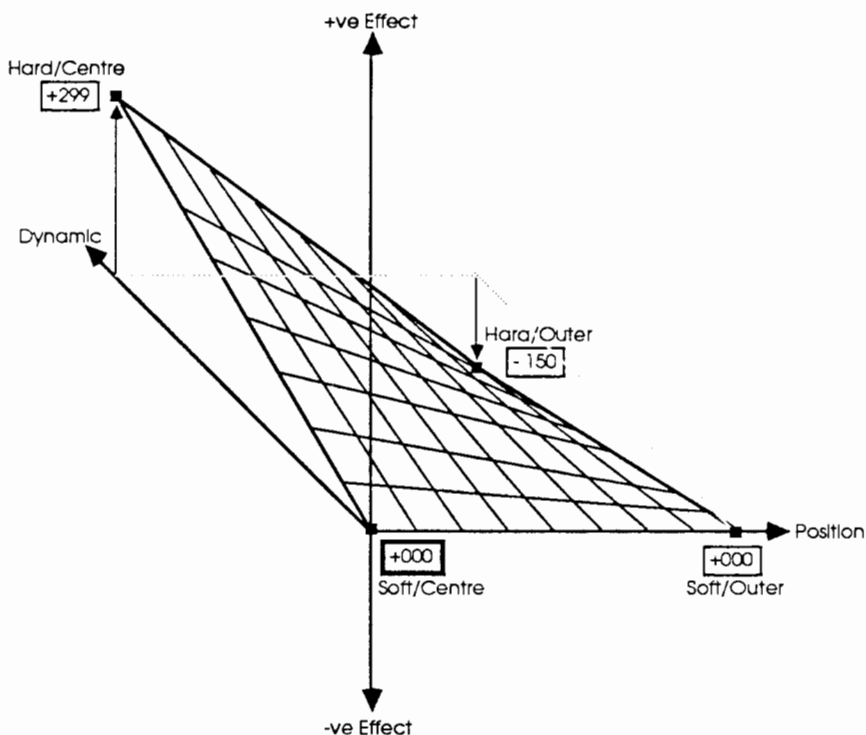

This Active Surface has a positive Effect with Hard hits in the Centre of the Pad, decreasing with movement across the Pad until producing a negative Effect at the Outer edge.

As you can see the Surface can be twisted in a number of ways to produce Audibly complex results from normal Dynamic and Positional playing techniques.

OPENING A SURFACE WINDOW

The Drum Head Screen displays all the Active Surfaces which make up the Head and allows the Range of each to be adjusted. To see how a Surface is constructed, click on the Snare's **Pitch Env.**

A **Surface Construction Window** will open.

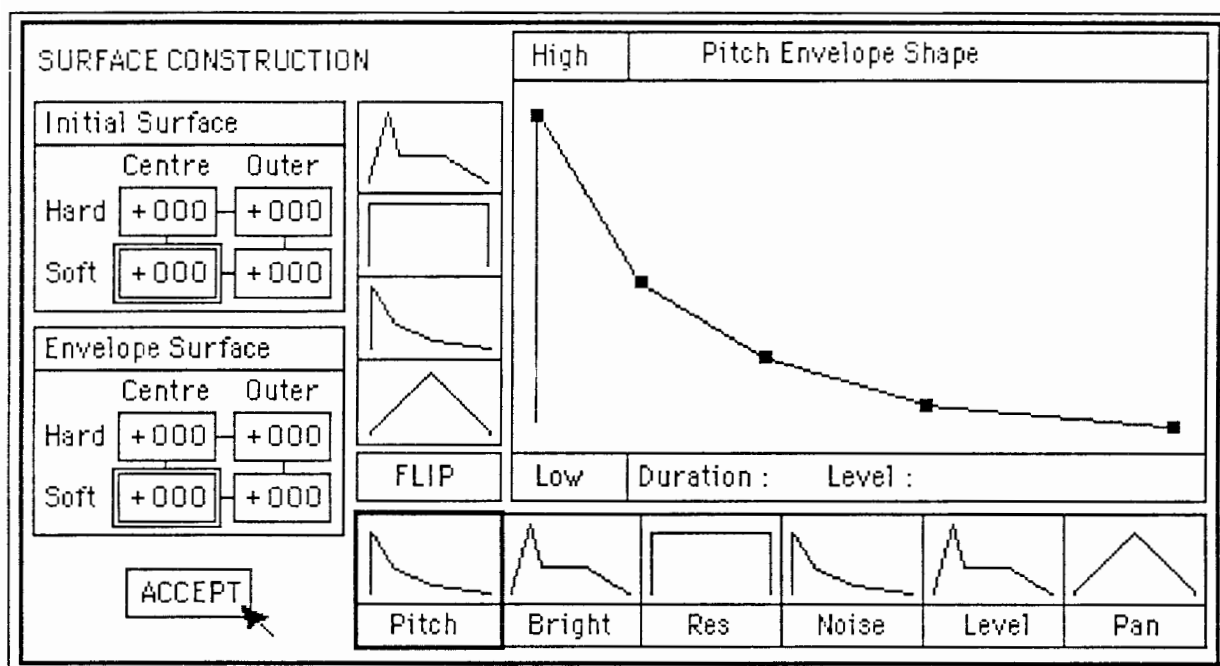

In the Window you will see two groups of numbers called the **Initial Surface** and the **Envelope Surface**.

- **Initial Surface**

An Initial Surface controls the **Amount of Effect** produced. As you increase the Surface the Effect increases and as you decrease the Surface the Effect decreases.

- **Envelope Surface**

An Envelope Surface controls the **Amount of Envelope** produced. As the Surface increases positively, the Amount of positive Envelope increases and as the Surface increases negatively, the Amount of negative Envelope increases.

Each group of numbers define the **co-ordinates** of a Surface.

Since we opened a Surface Construction Window for **Pitch**, any increase or decrease in the **Effect** will cause an increase or decrease in Pitch.

ENVELOPES

The **Envelope Surface** determines the **Amount** of Envelope produced.

Note that the Amount of Envelope produced by the **Envelope Surface** will be **added** to the current value produced by the **Initial Surface**. Therefore, the Initial Surface determines where the Effect Starts and the Envelope Surface determines how the Effect changes during the Duration of the Sound.

Envelope Shape

The largest section of the Surface Window shows the current shape of Envelope, in this case Pitch. You can reshape this Envelope by pointing to any one of 5 boxes, press the Select Button, then Drag it around using the Tracker Ball. As the point moves, it's **Duration** and **Length** will be displayed under the Envelope, from 0 to 499. Each Duration is relative to the last box, but the Level is absolute. The start point of the Envelope is fixed.

Note that the Envelope Shape is always positive, but you can produce negative Envelopes by selecting negative Envelope Surface co-ordinates.

Preset Envelope Shapes

Along the left-hand side of the Shape Window are four **Preset Shape** Icons. These Icons represent typical Shapes which you can use to save time when generating new ones. Clicking on the Icon which is most like the Shape you want to produce, will cause a full-size version to be displayed. You can then modify it to your requirements.

Flip Envelope

Clicking the **Flip** box will cause the Envelope Shape to be reversed. You can use this to create new Envelope Shapes, or to reverse the Shape to match a Sample which has been reversed.

Other Envelopes

All of the 6 available Envelope Surfaces are displayed as **Shape Icons** along the bottom of the Window. Since we opened the Pitch Surface Window the Pitch Icon is highlighted.

You can jump to any of the other Surface Windows by clicking on the name of the Icon you require. The full-size Shape of the new Surface will now be displayed, as are it's **Initial** and **Envelope** Surface co-ordinates.

If you change the Shape of the Envelope, but you wish to revert the Shape it had when you opened the Window, clicking on the Surface's Icon will recover the previous Shape, losing any recent edits.

Copying Envelope Shapes

To copy an Envelope Shape from another Surface, simply click on the Shape Icon of the Surface you wish to copy. As long as you do not move to another Surface, by clicking the Surface Name or closing the Window, you can recover the previous Shape by clicking on the current Surface's Icon.

CLOSING THE SURFACE WINDOW

Once you have defined the **Initial** and **Envelope** Surfaces and Shaped the Envelope you can close the Surface Window by clicking **Accept**. All the parameters will be retained when you close the Window and will can be saved as part of the Drum when you leave the **Drum Head** Screen.

ADDING A NEW SURFACE

Only **Active Surfaces** are listed on the Drum Head Screen. If a Surface has no Effect then you don't need to know about it. Or, to put it another way, What you see is what you get !

When you start with a new Drum only the **Level Env** Surface is displayed, since the Level VCA must be opened to hear any sound. All other Surfaces are **Inactive** since their **co-ordinates** are set to zero.

This does not mean that all the Voice parameters are zero. When there are no Active Surfaces the Drum produced will be the current Sample, replayed at it's Sample Rate, with no Noise, Filter or Pan treatment.

Adding an Initial Surface

To add an Initial Surface, point to the **Surfaces** box and choose a Surface from the displayed Menu. When the Select Button is released, the relevant **Surface Construction Window** is opened.

Adjusting any of the Surface co-ordinates on the **Initial Surface** will make the chosen Surface **Active** since it now produces an Effect. Clicking the **Accept** box will close the Window and the name of the Surface will appear in the Surface Type list on the Drum Head Screen.

Adding an Envelope Surface

To add an Envelope Surface, point to the **Surfaces** box and choose a Surface from the displayed Menu. When the Select Button is released, the relevant **Surface Construction Window** is opened.

Adjusting any of the Surface co-ordinates on the **Envelope Surface** will make the chosen Surface **Active** since it now produces an Effect. Clicking the **Accept** box will close the Window and the name of the Surface Envelope will appear in the Surface Type list on the Drum Head Screen.

Adjusting the Surface Range

Once a Surface has been added to the Surface Type list, you can increase or decrease its **Range**. When you increase or decrease the Range value you are actually adjusting the **Soft/Centre** co-ordinate of the Surface, moving the whole Surface up or down and creating more or less Effect.

If the only Active co-ordinate on a Surface is the **Soft/Centre** value and you reduce it to zero on the Drum Head Screen by setting Range to zero, this Surface will no longer be Active. However, it will still be displayed allowing you to increase or decrease the value, as long as you remain on the Drum Head Screen. If you Quit this Screen or move to the **Sample Assign** Screen, it will be removed from the list.

Pitch Surfaces

When you select **Pitch** from the **Surface Menu**, or click on either **Pitch** or **Pitch Env** from the **Surface Type** list, a Surface Construction Window for Pitch is opened; as shown on page 4-16.

- **Initial Pitch Surface**

When all the co-ordinates of the **Initial Pitch Surface** are zero the Surface is Inactive and the current Sample will be played back at the same Rate it was Sampled at.

You can Increase or Decrease the Pitch Surface causing a rise or fall in Pitch.

The Range of each co-ordinate is +249 to -249.

- **Pitch Envelope Surface**

When all the co-ordinates of the **Pitch Envelope Surface** are zero the Surface is Inactive and the current Sample be played back at the Pitch defined by the Initial Pitch Surface.

You can use the Pitch Envelope Surface to control the amount of Pitch Bend added to the Initial Surface. The Pitch Bend Envelope will follow the Shape shown in the Window.

When the Effect is positive the Envelope Shape will be upright, when the Effect is negative the Envelope Shape will be inverted.

Brightness Surfaces

When you select **Brightness** from the **Surface Menu**, or click on either **Brightness** or **Brightness Env** from the **Surface Type** list, a Surface Construction Window for Brightness is opened :

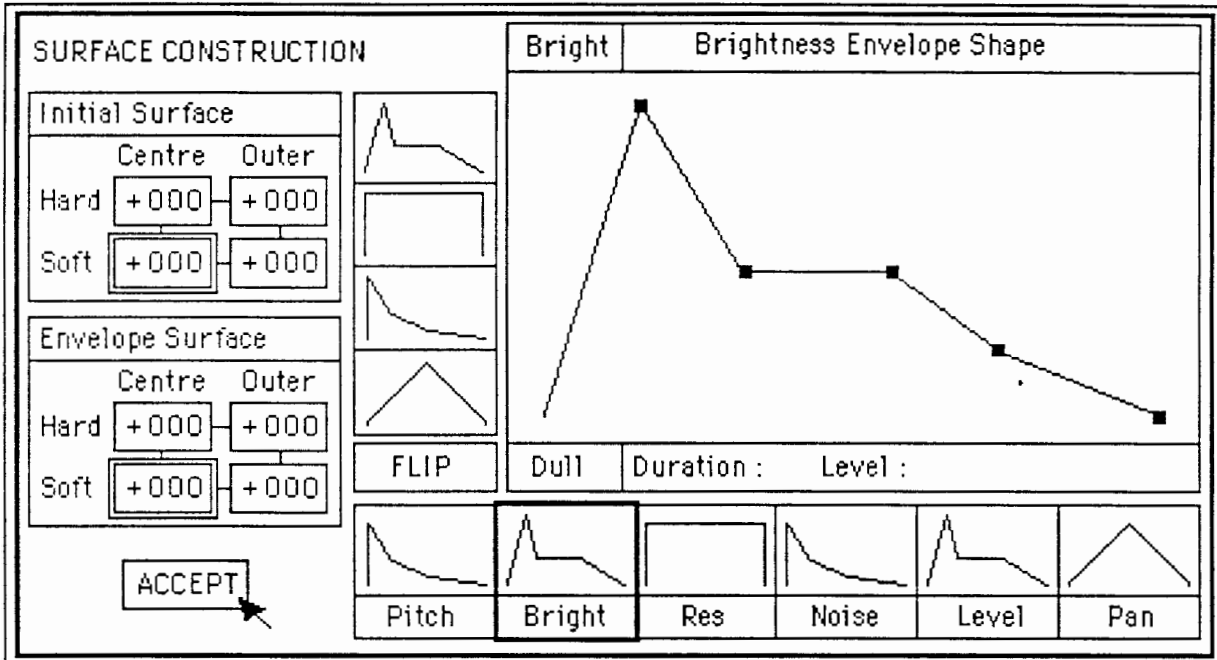

- **Initial Brightness Surface**

When all the co-ordinates of the **Initial Brightness Surface** are zero the Surface is Inactive and the current Sample will be played back with the Filter fully open.

You can Decrease the Initial Brightness Surface to close down the Filter, reducing it's Cut-Off frequency.

The Range of each co-ordinate is +0 to -499.

- **Brightness Envelope Surface**

When all the co-ordinates of the **Brightness Envelope Surface** are zero the Surface is Inactive and the current Sample will be played back with the Filter Cut-Off set by the Initial Brightness Surface.

You can use the Brightness Envelope Surface to control the amount of Filter Sweep added to the Initial Surface. The Filter Sweep Envelope will follow the Shape shown in the Window.

When the Effect is positive the Envelope Shape will be upright, when the Effect is negative the Envelope Shape will be inverted.

The Range of each co-ordinate is +499 to -499.

Resonance Surfaces

When you select **Resonance** from the **Surface Menu**, or click on either **Resonance** or **Resonance Env** from the **Surface Type** list, a Surface Construction Window for Resonance is opened :

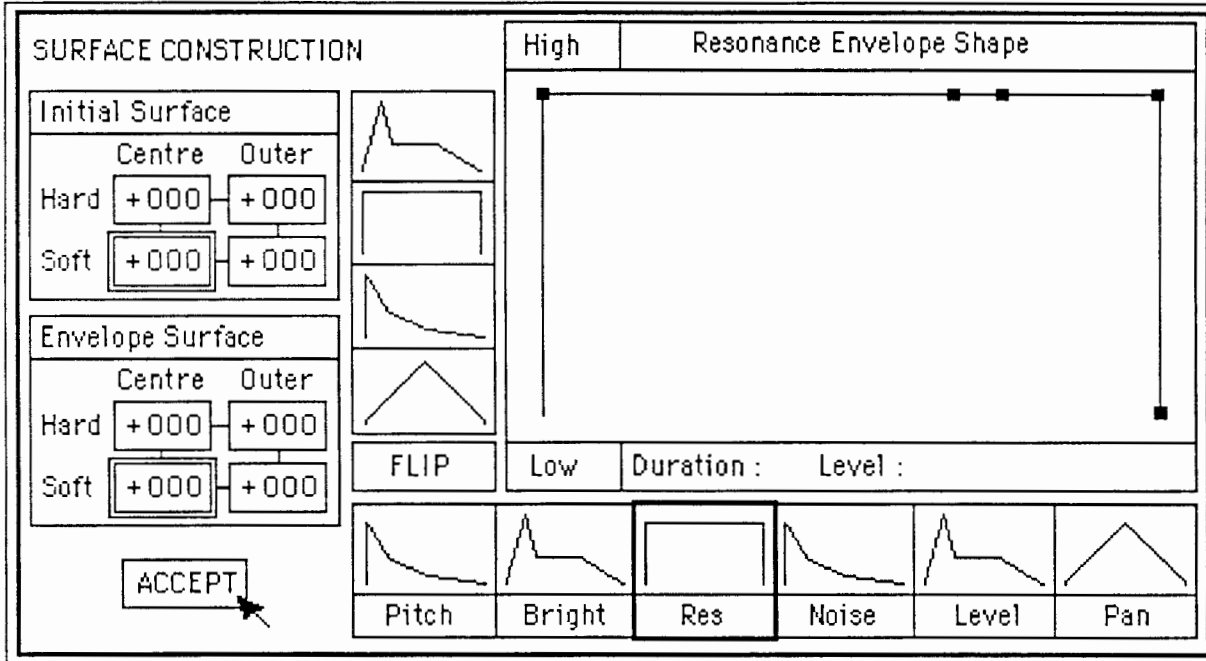

- **Initial Resonance Surface**
 When all the co-ordinates of the **Initial Resonance Surface** are zero the Surface is Inactive and the current Sample will be played back with the Filter Resonance set to minimum.

You can Increase the Initial Resonance Surface to increase the amount of Filter Resonance, accentuating the Cut-Off frequency.

The Range of each co-ordinate is +0 to +499.
- **Resonance Envelope Surface**
 When all the co-ordinates of the **Resonance Envelope Surface** are zero the Surface is Inactive and the current Sample will be played back with the Filter Resonance set by the Initial Resonance Surface.

You can use the Resonance Envelope Surface to control the amount of Resonance Sweep added to the Initial Surface. The Resonance Sweep Envelope will follow the Shape shown in the Window.

When the Effect is positive the Envelope Shape will be upright, when the Effect is negative the Envelope Shape will be inverted.

The Range of each co-ordinate is +499 to -499.

Noise Surfaces

When you select **Noise** from the **Surface Menu**, or click on either **Noise** or **Noise Env** from the **Surface Type** list, a Surface Construction Window for Noise is opened :

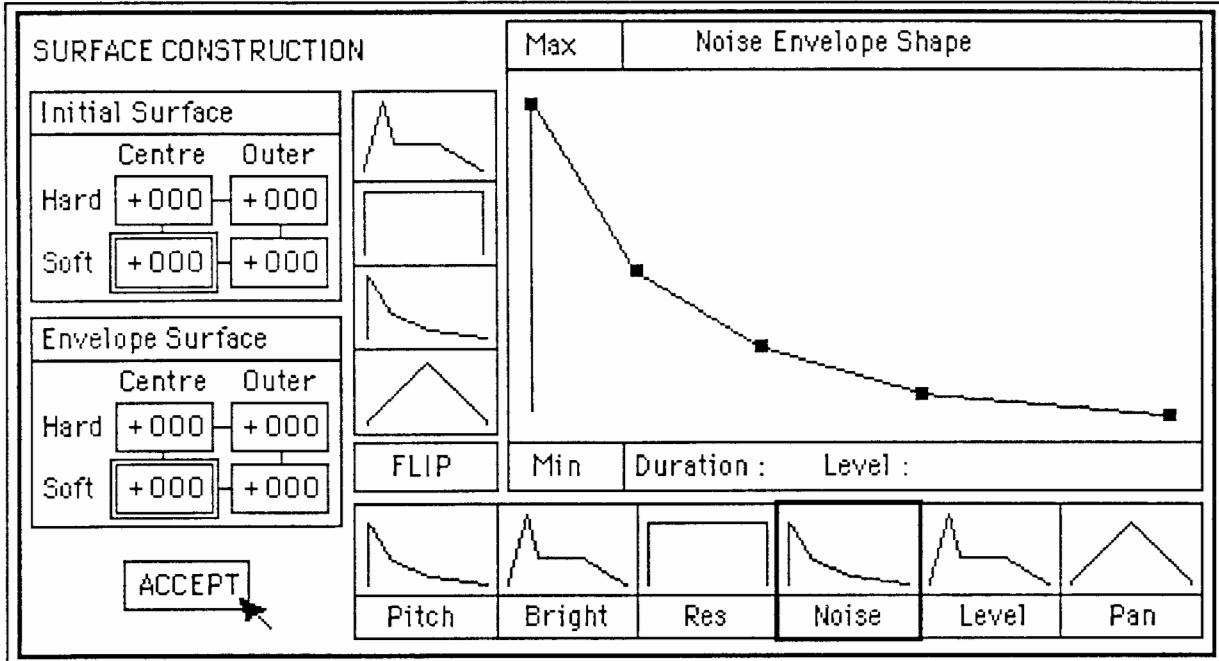

- **Initial Noise Surface**

When all the co-ordinates of the **Initial Noise Surface** are zero the Surface is Inactive and the current Sample will be played back with no Noise added.

You can Increase the Noise Surface causing the balance between Sample and Noise to change. At zero the mix will be no Noise / all Sample and at maximum, all Noise / no Sample.

The Range of each co-ordinate is +0 to +499.

- **Noise Envelope Surface**

When all the co-ordinates of the **Noise Envelope Surface** are zero the Surface is Inactive and the current balance between Sample and Noise will be defined by the Initial Noise Surface.

You can use the Noise Envelope Surface to control the amount of Noise Mix added to the Initial Surface. The Noise Mix Envelope will follow the Shape shown in the Window.

When the Effect is positive the Envelope Shape will be upright, when the Effect is negative the Envelope Shape will be inverted.

The Range of each co-ordinate is +499 to -499.

Level Surfaces

When you select **Level** from the **Surface Menu**, or click on **Level Env** from the **Surface Type** list, a Surface Construction Window for Level is opened :

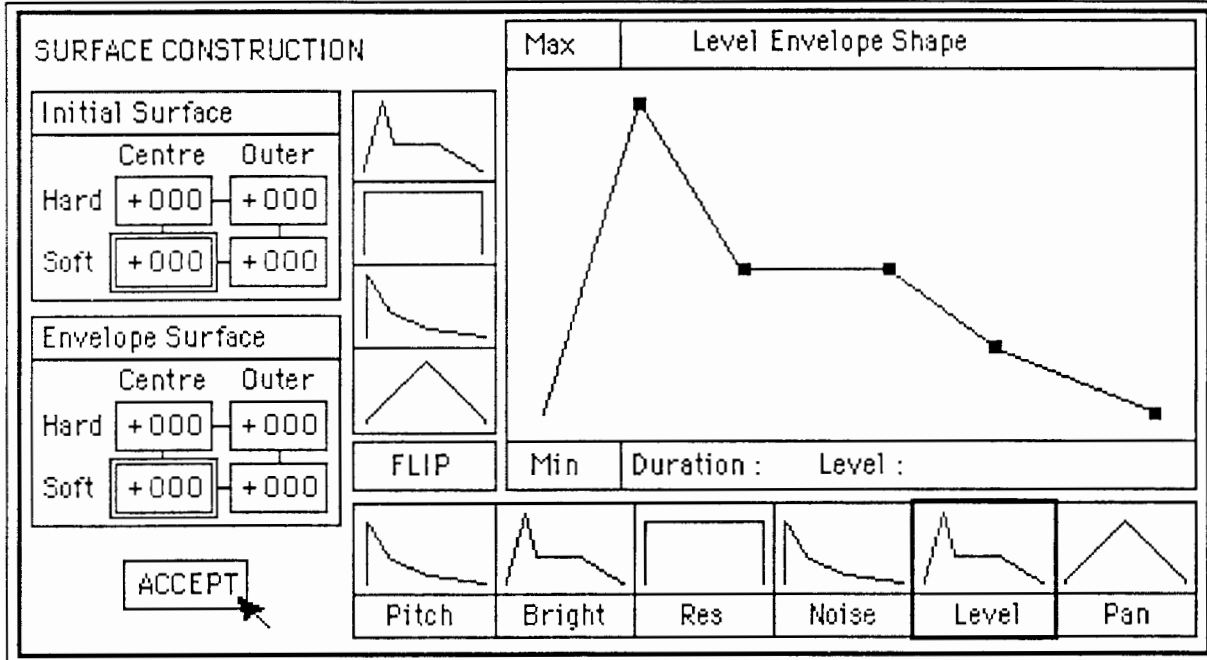

- **Level Envelope Surface**
If all the co-ordinates of the **Level Envelope Surface** were zero the Surface would be Inactive and Level VCA closed. Therefore the Envelope is normally at maximum Effect.

You can only use the Level Envelope Surface to reduce the amount of Dynamic Range. The Level Envelope will follow the Shape shown in the Window.

The Range of each co-ordinate is +499 to +0.

Pan Surfaces

When you select **Pan** from the **Surface Menu**, or click on either **Pan** or **Pan Env** from the **Surface Type** list, a Surface Construction Window for Pan is opened :

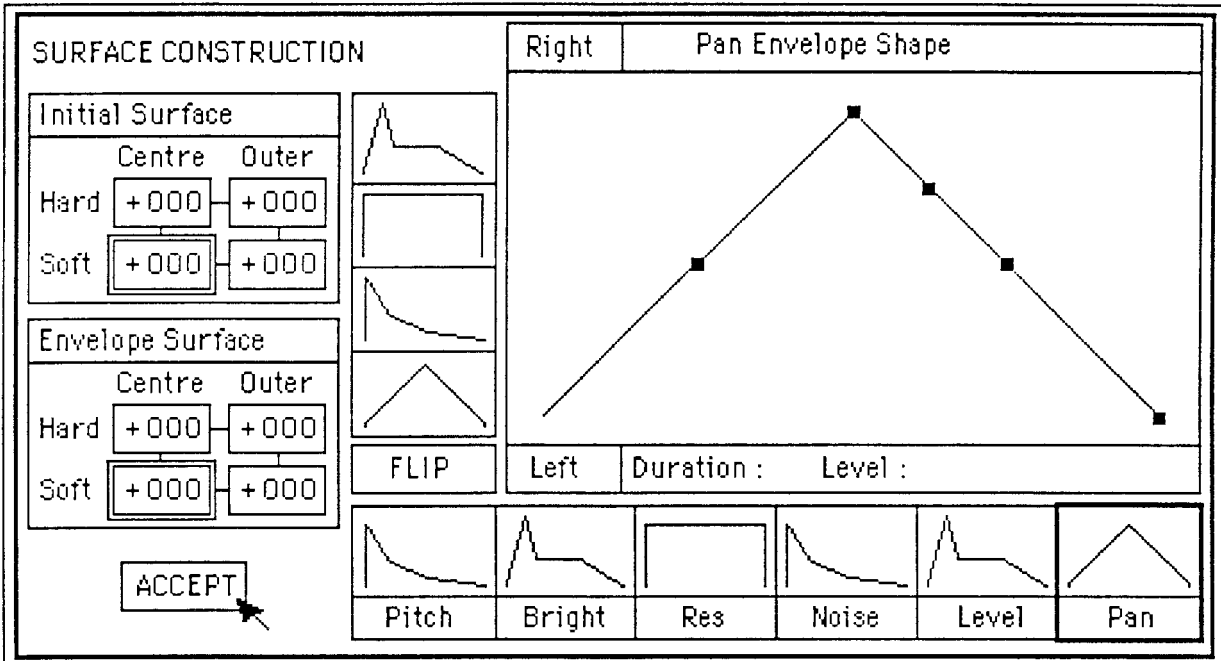

- **Initial Pan Surface**

When all the co-ordinates of the **Initial Pan Surface** are zero the Surface is Inactive and the current Sample will be placed in the Centre of the Stereo image.

You can Increase or Decrease the Pan Surface causing a the Sample to be moved from Right to Left in the Stereo image.

The Range of each co-ordinate is +249 to -249.

- **Pan Envelope Surface**

When all the co-ordinates of the **Pan Envelope Surface** are zero the Surface is Inactive and the current Sample will be placed in the Stereo Image as defined by the Initial Pan Surface.

You can use the Pan Envelope Surface to control the amount of Pan Sweep added to the Initial Surface. The Pan Sweep Envelope will follow the Shape shown in the Window.

When the Effect is positive the Pan will be from Left to Right, when the Effect is negative the Pan will be from Right to Left.

The Range of each co-ordinate is +499 to -499.

4 - 69 You cannot move **Pan Soft/Centre** co-ordinates. The Initial Pan Position is defined by the setting on the Mixer Screen.

Length Surface

When you select **Length** from the **Surface Menu**, or click on **Length** from the **Surface Type** list, a Surface Construction Window for Length is opened :

	Centre	Outer
Hard	+000	+000
Soft	+000	+000

ACCEPT

- **Initial Length Surface**

When all the co-ordinates of the **Initial Length Surface** are zero the Surface is Inactive and all the Envelopes will be the same Duration as the current Sample.

You can Decrease the Length Surface causing the Envelopes to be shorter than the duration of the current Sample.

The Range of each co-ordinate is +0 to -499.

Sample Start Surface

When you select **SampleStart** from the **Surface Menu**, or click on either **SampleStart** from the **Surface Type** list, a Surface Construction Window for SampleStart is opened :

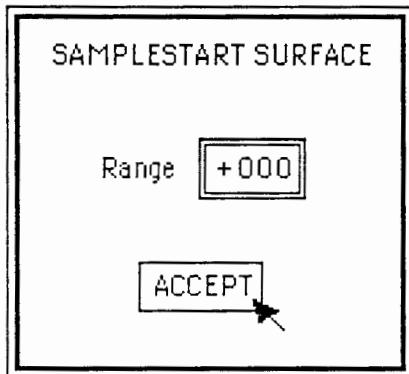

- **SampleStart Surface**
When the value of the **SampleStart Surface** is zero the Surface is Inactive and the Sample will always be played from the beginning.

You can increase the SampleStart Surface co-ordinate moving the Start point further into the Sample. As the Dynamic value of a hit increases the Start point of the Sample will move back towards the beginning of the Sample. Maximum Dynamic values will cause the Sample to be played from the beginning.

Only Dynamic values effect the SampleStart Surface.

The Range of SampleStart is +0 to +499.

MOVING TO THE SAMPLE ASSIGN SCREEN

While you are working with the Drum Head Screen you can move directly to the Sample Assign Screen. Since both Screens are inside the same Drum and therefore on the same level, you can swap between them without saving any changes.

Point to the **NEXT** box, and while holding the Select button to show the **Next Menu**, roll the Tracker Ball down until the arrow is pointing to **Drum Sample Assign**, then release the Select button. The Sample Assign Screen is displayed. You can now carry out any changes to the Sample Assignments as described in **Using Sample Assign**. To return to the Drum Head again select **Drum Head** from the **Next Menu**.

When you **Quit** from either of these Screens, to return to the Kit Configuration Screen, the **Save Changes Window** will allow all changes made to the current Drum to be Saved.

SAVING YOUR CHANGES

Once you have created a Drum Head you particularly like, you can save it to Memory - remember that all data will be lost when you power down - or save it to Disk, as a new Drum, or as part of a new Kit.

Save Drum

Selecting **Save Drum** from the **Memory** menu will save any changes made to the Drum Head as part of the Drum in Memory, replacing the previous Head. This will not effect the same Drum on your Disk. You should select **Save Drum** from the **Disk** menu if you wish to save the Head as part of the Drum on Disk.

Save Drum As

Selecting **Save Drum As** from the **Memory** menu will save the Head as a new Drum in Memory, leaving the previous one as it was. Selecting **Save Drum As** from the **Disk** menu will save any changes as a new Drum on Disk. The Disk must be Unprotected.

When **Save Drum As** is chosen, the **Alphanumeric Keyboard Window** opens, allowing the new Drum to be named.

To enter your new Drum name, using up to 11 characters, simply click on the letter or numbers in sequence. Upper case letters can be selected by clicking **Caps**. Click **Del** if you want to back-space or **Clear** to clear the entry. Common Drum names and the **Last Name** used are also available and are typed when clicked.

If you wish to cancel the **Save Drum As** operation, click **Quit**.

Click **Accept** when you are happy with the name. The new Drum will have the same Sample Assignment as before but will have the new Drum Head.

If the name you have chosen already exists, the **Name Exists Window** will open. This gives you the option to **Rename** the current Drum, using the Alphanumeric Keyboard again, **Replace** the Drum, overwriting it with the same name, or **Quit** the **Save Drum As** operation.

LEAVING THE DRUM HEAD SCREEN

Once you have finished working with the current Drum you can return to the Kit Configuration Screen by selecting **Quit** from the **Next Menu**.

If you have altered the Head of the Drum, but have not saved it, a **Save Changes Window** is displayed, before you can leave the Screen.

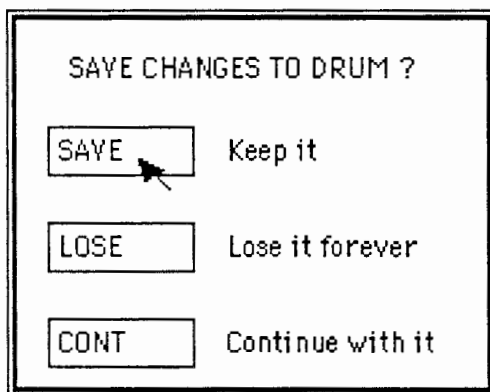

Save

If you wish to keep the recent changes, click on the **Save** box. The **Name Exists Window** will open.

This window allows you to **Replace** the current Drum with the changes, **Rename** it to create another with the new Head, leaving the original intact, or **Quit** to cancel the Save operation and remain on the Drum Head Screen.

Lose

If you don't want to save any changes, click on the **Lose** box. This leaves the Head as it was when you loaded the Drum, losing any changes you made. The Kit Configuration Screen will now be displayed.

Cont

If you selected **Quit** from the **Next Menu** by mistake, or changed your mind about leaving the Drum Head Screen, you can cancel the Quit operation and continue, by clicking the **Cont** box.

Creative Use of SDX

Section 4.5

Using SDX: Sampler Screen

CONTENTS

What is a Sample ?	4 - 75	Special Functions	4 - 94
Sound Transmission	4 - 75	Clear Samples Not In Window	4 - 94
Sound Waveforms	4 - 75	Reverse Samples In Window	4 - 94
Sound Sampling	4 - 75	Maximise Sample Amplitude	4 - 95
Selecting the Sampler Screen	4 - 77	Utility Functions	4 - 95
Making a New Sample	4 - 77	Editing Other Samples	4 - 95
Sample Length	4 - 78	Edit Sample from Memory	4 - 96
Sample Rate	4 - 78	Edit Sample from Disk	4 - 97
Sample Name	4 - 80	From Sample Assign Screen	4 - 97
Sample Start Point	4 - 80	Sample Protection	4 - 98
Sample End Point	4 - 80	Leaving the Sampler Screen	4 - 99
Connecting Audio	4 - 80	Save	4 - 99
Preview	4 - 80	Lose	4 - 99
Zoom Window	4 - 81	Cont	4 - 99
Peak Meter	4 - 82		
Threshold Adjust	4 - 82		
Sample	4 - 82		
Sample Window	4 - 83		
Creating Another New Sample	4 - 83		
Save	4 - 84		
Lose	4 - 84		
Cont	4 - 84		
New Sample Window	4 - 84		
Saving your New Sample	4 - 84		
Save Sample	4 - 84		
Save Sample As	4 - 85		
Deleting Samples	4 - 85		
Deleting Samples from Memory	4 - 85		
Deleting Samples from Disk	4 - 86		
Editing A New Sample	4 - 86		
Marker Select	4 - 86		
Truncate Pointers	4 - 87		
Truncate Start Point	4 - 87		
Truncate End Point	4 - 87		
Loop Pointers	4 - 89		
Loop Start Point	4 - 89		
Loop End Point	4 - 90		
Looping Samples	4 - 90		
Finding Good Loop Points	4 - 90		
Looping Options	4 - 91		

Creative Use of SDX

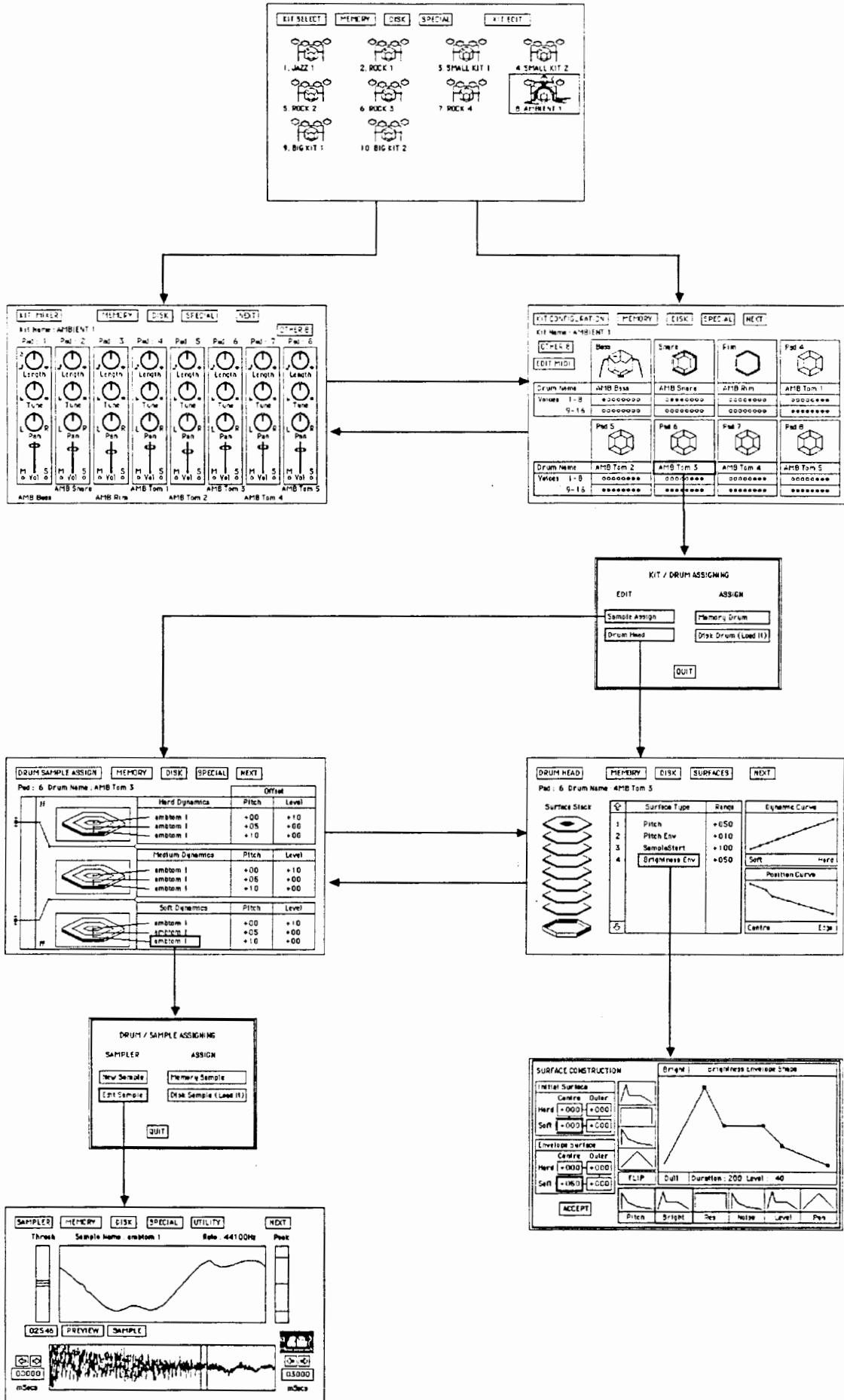

Using the **Sample Assign** and **Drum Head** Screens you should have tried building your own Drums, from the Sample Assignments and Heads supplied in the Sound Disk Library. You may now wish to Edit the Library Samples or create your own custom Samples.

The **Sampler Screen** allows you to edit **individual** Samples, by loading them from Disk, then Truncating, Looping or Reversing the Samples in Memory. You can also Sample original Sounds from the Sampler's Audio Input at various **Sample Rates**.

WHAT IS A SAMPLE ?

Before we look at the Sampler Screen let's review some Sampling basics.

Sound Transmission

Sound from an acoustic instrument is transmitted by vibrating the air around us. When our eardrums are moved by the vibrating air, the ear converts this movement into a series of electrical impulses which are sent to the brain causing us to 'hear' the sound. Since microphones convert air vibrations into electrical impulses, we can use a microphone as an 'eardrum', connected to SDX allowing it to 'hear' the sound.

In order for us to create sound, such as talking, our brains stimulate vocal chords causing them to vibrate the air around us. SDX can create sound using it's electrical voice outputs to stimulate a loudspeaker (via an amplifier), vibrating the surrounding air.

This is obviously an over-simplification, but it does illustrate how we can convert sound into electrical signals and back again.

Sound Waveforms

Sound Waves are periodic, that is, they repeat at a number of vibrations per second. The **Pitch** of a sound is determined by the number of repeated vibrations per second, known as the **Frequency**. This is normally expressed in Hertz, or cycles per second. Our ears have a range of around 20 Hz to 20,000 Hz, depending on age and exposure to Heavy Metal !

If we were to take a simple Waveform, the Sine Wave and plot it's loudness, or Amplitude, against Time, it would look as follows :

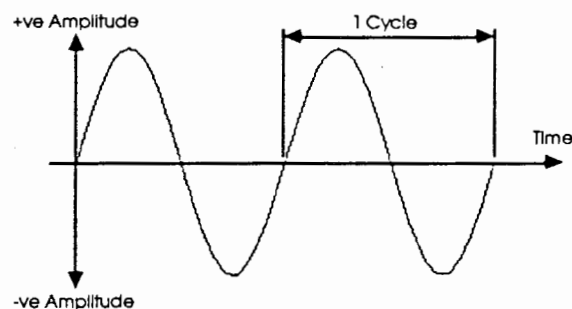

The Amplitude can have both positive and negative values. Consider the movement of a speaker, where the zero line represents the cone at rest. The cone would move outwards for positive values and inwards for negative values. It repeats the same movement over a period of time, the faster it goes, the more cycles per second, the higher the Pitch.

Sound Sampling

At the heart of SDX is a powerful computer, but computers don't know anything about Waveforms or Sound, they only know about numbers.

Sampling is basically a process for digitising Sound, that is turning it into a series of numbers which the computer can input, store and output.

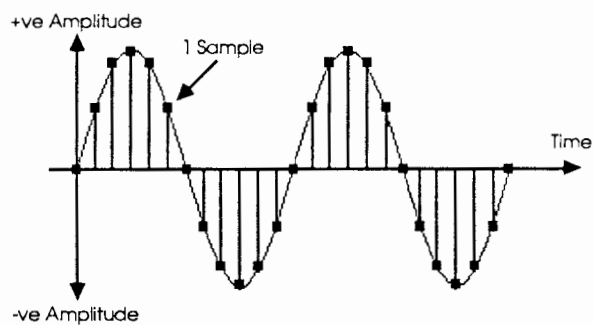

The Amplitude of the Waveform is measured thousands of times a second to produce a collection of 'snap-shot' Samples. Each Amplitude Sample is converted into number which the computer can store.

By converting these numbers back into Amplitude Samples at the same rate the Computer can reconstruct the Waveform from its numeric data.

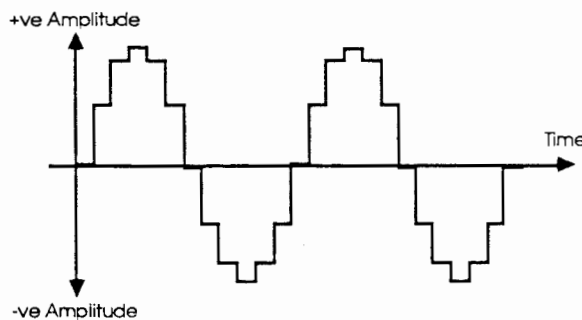

There are two important factors which effect the computer's ability to accurately reproduce an audio signal.

- **Sample Rate**

According to Sampling Theory, which we won't go into here, the Sampling Rate must be at least twice as high as the highest Frequency you intend to Sample. Therefore, if we are to reproduce any sound within the limits of human hearing, we must Sample at a minimum of 40,000 times per second ! SDX normally Samples at the CD standard for Digital Audio of 44,100 Samples per second.

- **Conversion Resolution**

The accuracy of Amplitude conversion is another important factor. From the diagram above you can see that the reconstructed waveform consists of a number of discrete steps, each produced by a finite number. The larger the range of numbers used to describe the Amplitude is, the smaller the steps are and correspondingly the more accurate the reconstructed Waveform will be. SDX incorporates, CD standard, 16 Bit Convertors which produce 65,536 finite levels !

The Sampler Screen lets you view and edit Waveforms which have been Sampled from SDX's Audio Input.

SELECTING THE SAMPLER SCREEN

The **Sampler Screen** is invoked from the **Sample Assign Screen** by clicking on the Sample Name of the Sample you wish to replace and selecting **New Sample** or **Edit Sample** from the **Drum/Sample Assigning** Window. Note that you do not lose the current Sample, it will still in Memory, but no longer assigned.

MAKING A NEW SAMPLE

Let's replace the current **Snare** with a New Sample.

- From the **Kit Configuration Screen**, click on **Drum Name** for the Snare. The **Kit/Drum Assigning** Window appears.
- Now click the **Sample Assign** box to display the **Sample Assign Screen**.
- If all the displayed Samples do not have the same name, select **Set All as Soft/Outer** from the **Special Menu**.

This will assign the Soft/Outer Sample to all Dynamics and Positions on the Snare Pad. Our new Sample will be assigned to the Soft/Outer position so that we can preview the new Sample.

- Click on the **Soft/Outer** Sample Name. The **Drum/ Sample Assigning** Window appears.
- Click on the **New Sample** box.

The choice of Sample Rate is always a compromise between Sample Fidelity and Memory Usage. When you enter the Sampler Screen, SDX will always default to 44,100Hz, the standard used for Compact Disc Digital Audio.

Ideally, you should always use the highest Rate available to retain the Signal quality, however, to conserve Memory Space you may wish to reduce the Sample Rate, provided that the input signal has a Bandwidth of less than half the selected Sample Rate.

- Sample Rate Signal Bandwidth

44,100 Hz	up to 22,050 Hz
22,050 Hz	up to 11,025 Hz
11,025 Hz	up to 5,013 Hz

To alter the Sample Rate place the Pointer on the Rate box, then press and hold the Select Button. The box will be highlighted allowing you to decrease the Rate, by rolling the Tracker Ball downwards, or increase it by rolling upwards. As you change the Sample Rate the Sample Length changes accordingly.

Once you have selected the Length and Rate you require, click **Accept**. The New Sample Window will close and the complete Sampler Screen will be displayed.

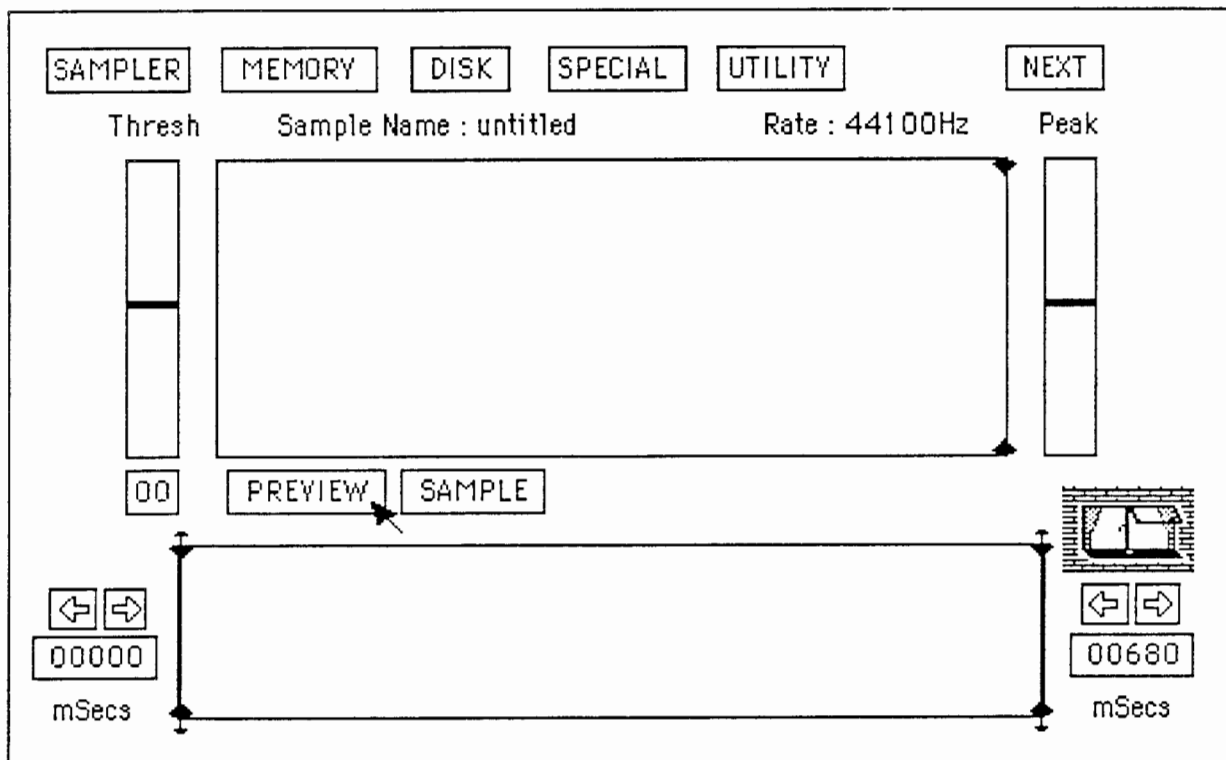

The chosen Sample Rate is now displayed on the Sampler Screen.

Sample Name

When you request a New Sample, SDX allocates the required amount of Memory and names the Sample **untitled**.

You can give the Sample a name at any time by selecting **Rename Sample** from the **Memory Menu**. This opens the **Alpha-numeric Keyboard** Window, allowing you to give the Sample an 11 character name.

Sample Start Point

At the bottom of the Screen, on the left-hand side, there is a numeric box which shows the **Start Point** of the Sample in milliseconds. For a New Sample this will be zero.

Sample End Point

On the right-hand side, there is a numeric box which shows the **End Point** of the Sample in milliseconds. For a New Sample this will be the Length chosen in the New Sample Window.

Connecting Audio to the Sampler

Connect the Audio Signal you intend to Sample, to the input on the rear panel of the SDX Console labelled, **Sample In**.

This input is **Balanced** and at **Line** level.

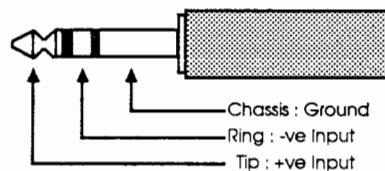

Connect a Stereo 1/4" jack as shown.

You can use a Mono 1/4" jack to connect a single-ended signal since the chassis of the plug will short the -ve Line input to ground.

The internal Analog to Digital convertor requires a signal of **+4dBm** for full scale conversion, therefore the input signal must be at Line Level, fed directly from another instrument or from a Mixing Desk.

You will have to boost Microphone signals through a low-noise pre-amplifier or Desk to produce enough level for Sampling.

Preview

Once the Audio Signal has been connected, click on the **Preview** button. This facility allows you to check the level of the Input Signal by displaying its Waveform in the **Zoom Window**.

The input is Sampled for the selected Sample Length, then displayed, then Sampled again. This operation is repeated continuously until you hold the left-hand Select Button to stop.

Obviously, the longer the Sample Length, the longer it takes for the Screen to be updated. You can speed up the Preview function by reducing the **End Point** value. This will cause shorter Samples to be taken and thereby causing the Screen to be updated more often.

Preview will not be retain the Sample in Memory.

Zoom Window

The **Zoom Window** displays a section of the input Waveform. The length of Waveform displayed is defined by the **Start Point** and **End Point** values. Once a Sample has been stored, you can use this Window to zoom into sections of a Waveform and see them in more detail.

Adjusting the level of the Input Signal will alter the height, or Amplitude, of the Waveform in the Zoom Window. The height of the Zoom Window itself represents Full-Scale conversion.

To retain the best **Signal to Noise Ratio** through SDX, you should always adjust the input level so that it's maximum value reaches the top and bottom lines of the Zoom Window without flattening out, or **Clipping**.

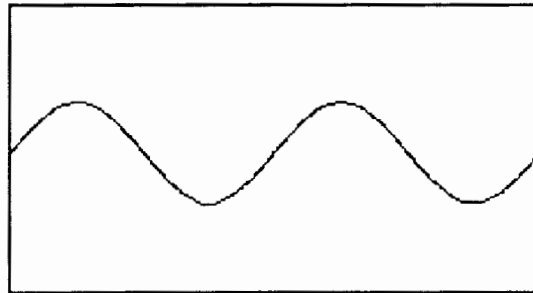

Input Level too low

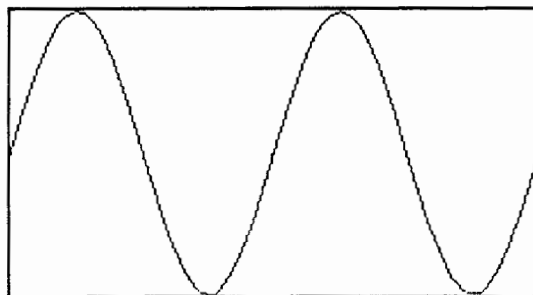

Input Level ideal

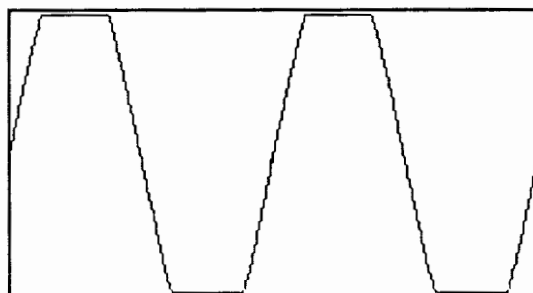

Input Level too high - Clipping

Peak Meter

When the Waveform is displayed in the Zoom Window, it's Peak value is shown in a **Peak Meter**, situated on the right-hand side of the Zoom Window. This allows you to see the maximum value of complex Waveforms more easily.

Once you have adjusted the Input level so that it fills the Zoom Window, without clipping, you are ready to Sample.

Threshold Adjust

The **Threshold** control can be used to set a minimum amplitude, which the Input signal must reach, before the Sampler will be triggered. This ensures that you always catch the beginning of the sound you wish to Sample.

To alter the Threshold point place the Pointer on the numeric box, next to Preview, then press and hold the Select Button. The box will be highlighted allowing you to increase the Threshold value, by rolling the Tracker Ball upwards, or decrease it by rolling downwards. As you change the numeric value, a graphic representation of the Threshold is displayed next to the Zoom Window.

The Threshold can be adjusted from 0 to 99.

Sample

Having set the Threshold you require, click on the **Sample** box.

- A **Sample ... Awaiting Trigger** message will be displayed. This shows that the Sampler is 'armed' and is waiting for the amplitude of the Input Signal to cross the Threshold.
- Trigger the Sampler by hitting the acoustic Drum, Cymbal or other Instrument that you wish to Sample.
- A **Sample ... Sampling** message will be displayed while SDX digitises the Input Signal and stores it into Memory.

Once the Sample has been stored in Memory it is displayed in the **Sample Window** and **Zoom Window**.

You can listen to the Sample by hitting the assigned Pad, in this case the Snare, or by clicking the right-hand Select Button.

If the Sampled version has some of the attack missing, reduce the Threshold value, click **Sample** again and repeat the sound.

If the amplitude of the displayed Waveform does not fill the Sample Window, increase the Input level, click **Sample** again and repeat the sound.

Every time you re-sample the previous version will be erased.

If the **Sample ... Awaiting Trigger** message is displayed and the sound you wish to Sample is not loud enough to trigger the Sampler, you can override the Threshold setting by clicking the left-hand Select Button.



Sample Window

The **Sample Window** shows the complete Sampled Waveform.

Inside this Window are two **View Bars**. These allows you to zoom in on any section of the Waveform shown in the Sample Window and display it in detail in the **Zoom Window**.

To move the left-hand View Bar place the Pointer on the **Start Point** box, then press and hold the Select Button. The box will be highlighted allowing you to increase the value, moving the Bar right, by rolling the Tracker Ball upwards or right. Conversely, rolling downwards or left will decrease the value moving the Bar left.

To move the right-hand View Bar place the Pointer on the **End Point** box, then press and hold the Select Button. The box will be highlighted allowing you to increase the value, moving the Bar right, by rolling the Tracker Ball upwards or right. Conversely, rolling downwards or left will decrease the value moving the Bar left.

When you release the Select Button, the Waveform in the Zoom Window will be updated.

The View Bars can also be single-stepped through the Waveform by clicking on the forward or backward arrows above the Numeric boxes.

CREATING ANOTHER NEW SAMPLE

If you wish to increase the Sample Length or change the Sample Rate you will have to create another New Sample. You can do this by selecting **New Sample** from the **Memory Menu**.

A **Save Changes Window** will open.

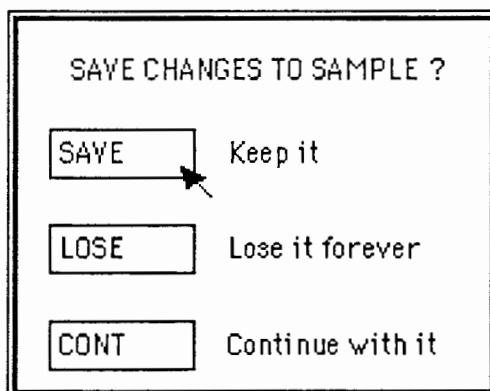

Save

To Save the Sample, click on the **Save** box.

If you have not already named the Sample an **Alphanumeric Keyboard Window** will appear, allowing you to give the new Sample an 11 character name.

If the name you have chosen already exists, the **Name Exists Window** will open. This gives you the option to **Rename** the new Sample, using the Alphanumeric Keyboard again, **Replace** the Sample with the same name, or **Quit** the **Save** operation.

Lose

If you don't want to keep the Sample, click on the **Lose** box. This frees the Memory space you allocated when you entered the Sampler, losing any Samples made.

Cont

If you selected **New Sample** from the **Memory Menu** by mistake, or changed your mind about making a New Sample, you can cancel this operation and continue, by clicking the **Cont** box.

New Sample Window

The Sampler Screen will be displayed with the **New Sample Window** on top, unless you canceled the selection by clicking **Cont**. You can now select a new Sample Length and Sample Rate as before.

SAVING YOUR NEW SAMPLE

Once you have created a Sample you particularly like, you should save it to Disk since all Memory contents will be lost when you power down.

Save Sample

Select **Save Sample** from the **Disk Menu** to save the Sample on Disk. If you have not already named the Sample an **Alphanumeric Keyboard Window** will appear.

To enter your new Sample name, using up to 11 characters, simply click on the letter or numbers in sequence. Upper case letters can be selected by clicking **Caps**. Click **Del** if you want to backspace or **Clear** to clear the entry. Common Drum names and the **Last Name** used are also available and are typed when clicked.

If you wish to cancel the **Save Sample** operation, click **Quit**.

Once you have entered the name click **Accept**.

The Disk must be unprotected.

Save Sample As

Selecting **Save Sample As** from the **Disk Menu** allows you to save a copy of the Sample on Disk with another name.

When **Save Sample As** is chosen, the **Alphanumeric Keyboard Window** opens, allowing the duplicate Sample to be named.

If you wish to cancel the **Save Sample As** operation, click **Quit**.

Once you have entered the name click **Accept**.

If the name you have chosen already exists, the **Name Exists Window** will open. This gives you the option to **Rename** the new Sample, using the Alphanumeric Keyboard again, **Replace** the current Sample, overwriting it with the same name, or **Quit** the **Save Sample As** operation.

DELETING SAMPLES

You may get to the point where you have been saving Samples to Memory and eventually run out of Memory space. You can free up some space by deleting Samples from Memory, however, make sure that you have Saved them to Disk first.

Deleting Samples from Memory

Selecting **Delete** from the **Memory Menu** will open a **Delete Memory Sample Catalog**.

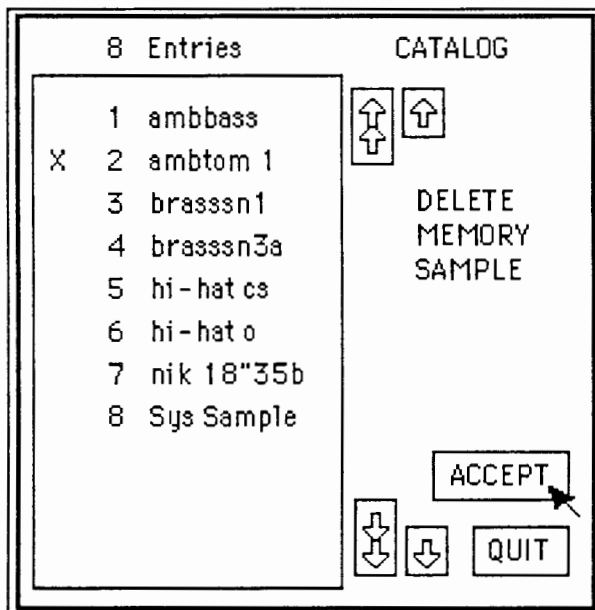

To select a Sample, click on the Sample Name. The Sample will be indicated with a cross. Click **Accept** to delete it.

The selected Sample will be deleted from Memory.

Deleting Samples from Disk

Samples can also be deleted from Disk by selecting **Delete** from the **Disk Menu**. A **Delete Disk Sample Catalog** will be displayed.

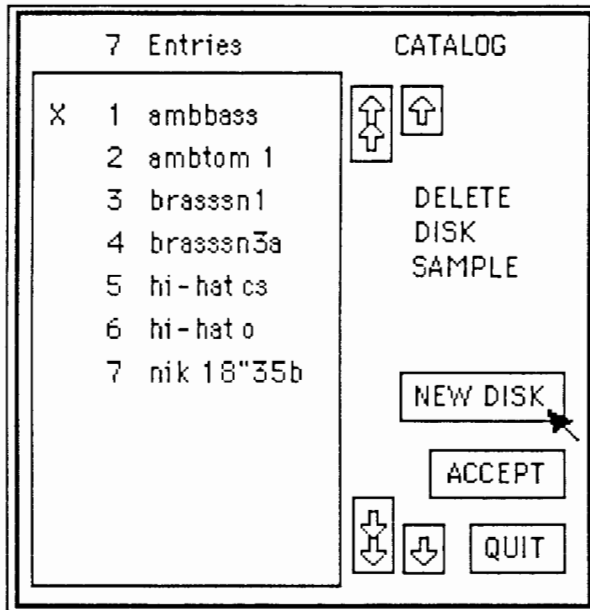

Select the Sample to be deleted from the Catalog and click **Accept** to delete it.

The Disk in the Drive must be Unprotected.

EDITING A NEW SAMPLE

Before you do any editing you should create a copy of the Sample on Disk. This is just a safety precaution since you cannot lose the changes you make to a Sample in the same way as you can a Drum or Kit. Any Edits made to the Sample will be permanent.



Marker Select

Below the Peak Meter is an icon representing a Window. This is the **Marker Select Icon**. If you click on the Window, it turns into a pair of Scissors. Click on the Scissors and they turn into a Loop. Click on the Loop and it turns into the Window again. These icons allows access to the **View**, **Truncate** and **Loop** Markers.



Truncate Pointers

When the **Scissors** icon is displayed, the **Start** and **End Point** values control the **Truncate Pointers**. These are represented by arrows on the bottom line of the Sample and Zoom Windows.

The Truncate Pointers are used to **Truncate** the beginning or end of the Sample. Only the part of the Waveform between the arrows will be played. You may wish to Truncate the tail of a Sample to remove unwanted noise, or you could truncate the beginning of a Sample to produce a faster attack.

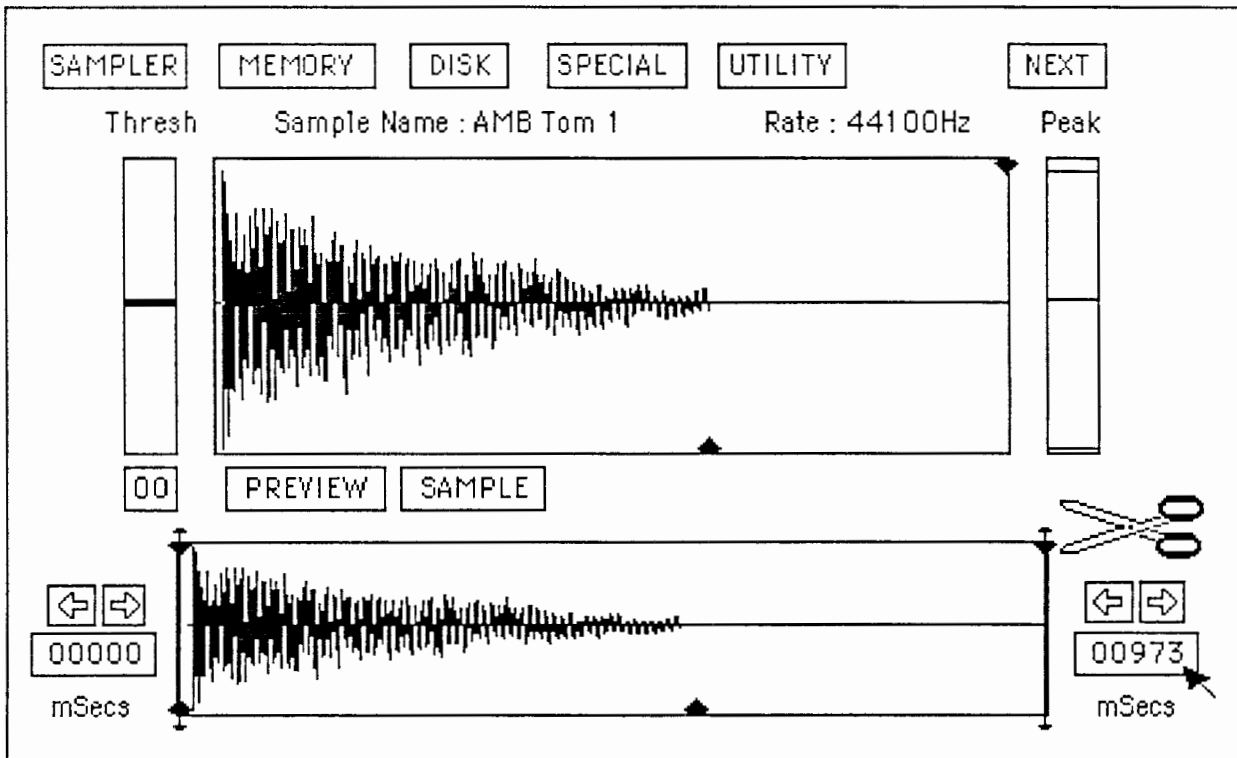

When you make a new Sample, SDX automatically sets the Truncate Pointers to the beginning and end of the chosen Sample Length.

- **Truncate Start Point**

To move the left-hand Truncate arrow place the Pointer on the **Start Point** box, then press and hold the Select Button. The box will be highlighted allowing you to increase the value, moving the arrow right, by rolling the Tracker Ball upwards or right. Conversely, rolling downwards, or left, will decrease the value moving the arrow left.

- **Truncate End Point**

To move the right-hand Truncate arrow place the Pointer on the **End Point** box, then press and hold the Select Button. The box will be highlighted allowing you to increase the value, moving the arrow right, by rolling the Tracker Ball upwards, or right. Conversely, rolling downwards, or left, will decrease the value moving the arrow left.

When you release the Select Button, only the section of Waveform between the Truncate Arrows will be played.

The Truncate Pointers can also be single-stepped through the Waveform by clicking on the forward or backward arrows above the Numeric boxes.

Save Sample Truncated

Once you have created a Truncated Sample you wish to keep, you can save it to **Memory** or to **Disk**. An Unprotected Disk must be used when saving to Disk.

Select **Save Sample Truncated** from the **Memory Menu** to save the Truncated Sample in Memory, replacing the previous version.

A **Save Changes Window** opens.

- **Save**
Click **Save** to save the Truncated version in Memory and return to the **Sample Assign Screen**.
- **Lose**
Click **Lose** to lose the Truncated version and return to the **Sample Assign Screen**.
- **Cont**
Click **Cont** to cancel the save operation and continue on the **Sampler Screen**.

Select **Save Sample Truncated** from the **Disk Menu** to save the Truncated Sample to Disk, replacing the previous version.

Save Sample Truncated to 2nd Loop Point

You can also save a Sample Truncated by the Loop End Point to **Memory** or to **Disk**. An Unprotected Disk must be used when saving to Disk.

Select **Save Sample Truncated to 2nd Loop Point** from the **Memory Menu** to save the Truncated Sample in Memory, replacing the previous version.

A **Save Changes Window** opens.

- **Save**
Click **Save** to save the Truncated version in Memory and return to the **Sample Assign Screen**.
- **Lose**
Click **Lose** to lose the Truncated version and return to the **Sample Assign Screen**.
- **Cont**
Click **Cont** to cancel the save operation and continue on the **Sampler Screen**.

Select **Save Sample Truncated to 2nd Loop Point** from the **Disk Menu** to save the Truncated Sample to Disk, replacing the previous version.



Loop Pointers

When the **Loop** Icon is displayed, the **Start** and **End Point** values control the **Loop Pointers**. These are represented by arrows on the top line of the Sample and Zoom Windows.

The Loop Pointers are used to **Loop** a section of the Sample. The Sample will be played normally up to the second Loop arrow, it then Loops to the first Loop arrow, repeating the required number of times, before finishing the Sample. This allows you to stretch a Sample, making it last longer, but taking up the same amount of Memory space. You can define both the number of Loops and Loop Direction.

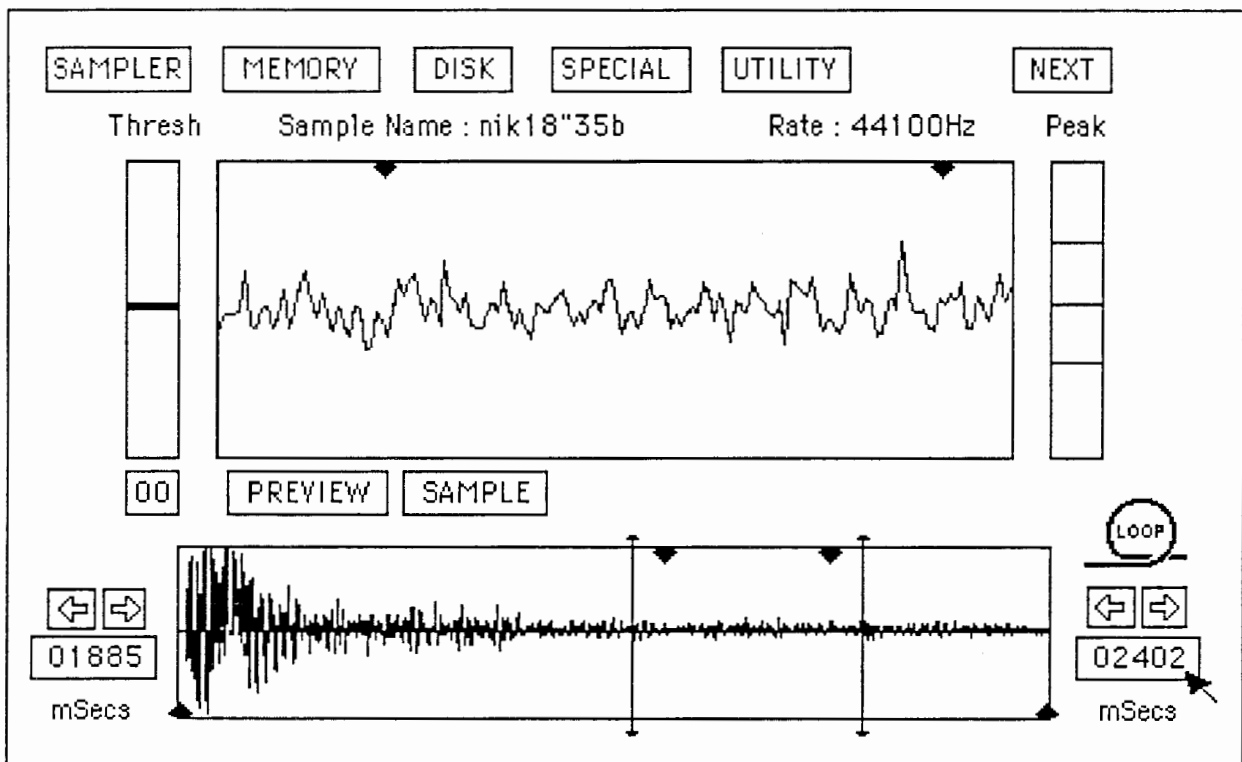

When you make a new Sample, SDX automatically sets the Loop Pointers to the beginning and end of the chosen Sample Length and the number of Loops to zero.

- **Loop Start Point**

To move the left-hand Loop arrow place the Pointer on the **Start Point** box, then press and hold the Select Button. The box will be highlighted allowing you to increase the value, moving the arrow right, by rolling the Tracker Ball upwards, or right. Conversely, rolling downwards, or left, will decrease the value moving the arrow left.

- **Loop End Point**

To move the right-hand Loop arrow place the Pointer on the **End Point** box, then press and hold the Select Button. The box will be highlighted allowing you to increase the value, moving the arrow right, by rolling the Tracker Ball upwards, or right. Conversely, rolling downwards, or left, will decrease the value moving the arrow left.

When you release the Select Button, the section of Waveform between the Loop Arrows will be looped.

The Loop Pointers can also be single-stepped through the Waveform by clicking on the forward or backward arrows above the Numeric boxes.

LOOPING SAMPLES

Looping Samples sounds simple in theory, but is not always that easy in practice. The object is to produce an invisible extension of the Sample. However, the ear is very sensitive to discontinuities, or glitches, and quickly detects repeating sections of sound.

Finding Good Loop Points

Most percussive sounds change rapidly in Amplitude and Harmonic Content during their attack period. As the sound dies away it becomes less complex and more cyclic in nature. Think of a Cymbal and the way its sound changes as it dies away.

Only certain types of Sample can be successfully looped. You should look for a section of the Waveform where the Amplitude is constant such as the Sustain period of a sound. The Pitch should also be stable, preferably without vibrato.

- Using the **View Bars** in the Sample Window, choose a section of the Waveform towards the end of the Sample.
- Look at the Waveform in the **Zoom Window**, moving the View Bars back and forth, until you find a section in which you can see a repeating pattern.
- Click on the **Marker Select** until it becomes the **Loop** icon.
- Now move the **Loop Pointers** until they are inside the Zoom Window and enclose the repeating section.

Try playing the Sample using the assigned Pad, in this case the Snare, or right-hand Select Button. When you move the Loop Pointers, SDX sets the number of Loops to 10, so you should hear the section of Waveform you have selected, repeated 10 times. Move the Loop Pointers around until you find a Loop which sounds fairly natural.

4 - 79 Four new icons have been added to the **Sampler Screen**.

By clicking on the Note icon, to the right of the Peak Meter, the current Sample can be triggered. The right-hand Select Button will perform the same function.

The Arrow icon, under the Zoom Window, shows the current Loop Direction. Clicking on the icon will alternate it between an arrow pointing to the right, representing Forward looping, and a two headed arrow representing Backward/Forward looping.

The FLP box allows the Find Loop Points function to be activated. This performs the same function as clicking the Find Loop Points box in the Looping Options Window.

The numeric box next to FLP sets the number of Loops. Setting a number of Loops here performs the same function as setting it in the Looping Options Window.

4 - 95 The Maximise Sample Amplitude option from the Special Menu, now allows you to adjust the amount of Gain, where 0dB is full Range.

You can set the amount of Gain from - 99 to +99 dB

4 - 101 The **Disk Operations Window** now has an INFO box. Click on this box to transfer to the **Disk Info Window**. The Disk Operations Window will be displayed again when you click Quit on the Disk Info Window. This feature allows you to check the Disk contents before carrying out any of the Other Disk Operations.

4 - 102 If the current Device is the Internal Drive it will be displayed as `fdp0`, not Int Floppy. An Internal Hard Disk it will be displayed as `scsi1`, not Hard Disk.

4 - 111 The Rename option now includes **Disk** as an Item Type, allowing you to rename a floppy Disk or Disk Slot.

Looping Options

Once you have defined the Points where you want the Loop to be, you can use the **Looping Options Window** to help you refine the Loop.

Choose **Loop Options** from the **Special Menu**. When you release the Select Button the **Looping Options Window** will open.

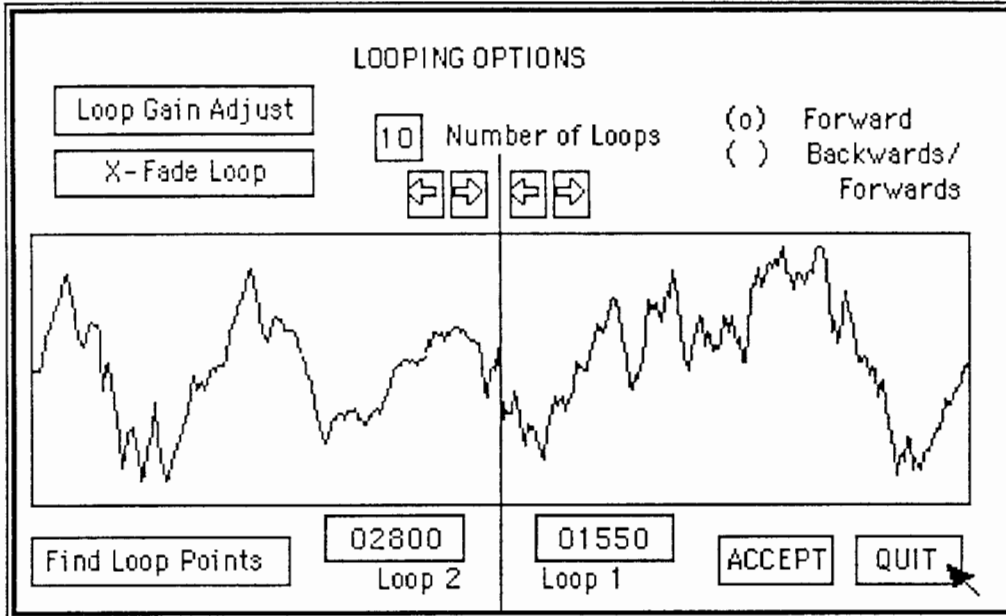

- **Number of Loops**

You can increase or decrease the number of Loops, from 0 to 99, by selecting the numeric box and rolling the Tracker Ball up or down.

If the Sample is assigned to a **Pitched Drum** and the Sample is triggered by a MIDI Note, the Loop Number will be ignored and the Loop will repeat until a MIDI Note Off is received.

- **Loop Type**

There are two Loop types which can be selected by clicking on the type name.

Forward causes the Sample to play forwards through the Loop then jump directly from the Loop End Point to the Loop Start Point.

Backwards/Forwards causes the Sample to play forwards through the Loop until the Loop End Point then play backwards from the End Point to the Loop Start Point then forwards again.

You should experiment with the two types

- **Loop Waveform**

The Window displays two sections of the Looped Waveform. These are the Start and End Points of the Loop. They have, however, been swapped round so that the Loop Start Point is on the right while the Loop End Point is on the left. The line separating the two Waveforms is the **Splice Point**, showing how the Start and End points join.

- **Loop 1**

The Loop Start Point can be moved by selecting the **Loop 1** numeric box and increasing or decreasing it's value by rolling the Tracker Ball up or down. The value can also be single-stepped by clicking on the forward or backward arrows above the Waveform.

- **Loop 2**

The Loop End Point can be moved by selecting the **Loop 2** numeric box and increasing or decreasing it's value by rolling the Tracker Ball up or down. The value can also be single-stepped by clicking on the forward or backwards arrows above the Waveform.

- **Find Loop Points**

To prevent Glitches in the Sample both Waveforms should have zero Amplitude and the same direction at the Splice Point.

Having manually defined the area of your Loop you can ask SDX to find the best Loop Start and End Points near by. Points will be chosen which have zero Amplitude and the same direction at the Splice Point.

Click on the **Find Loop Points** box.

- **Loop Gain Adjust**

If the Amplitude of the Waveform within your chosen Loop varies over the Loop length you will hear a sort of Tremelo effect. To prevent this you can flatten the Amplitude across the Loop by adjusting the Loop gain.

Click on the **Loop Gain Adjust** box.

Note that this operation will permanently effect the Sample, so you may wish to perform it on a copy, created using the **Save Sample As** option.

- **Cross Fade Loop**

If your Loop still sounds a little unnatural you can try Cross-Fading at the Loop Points.

A Cross-Fade Loop works as follows :

The current Loop is divided into two halves C and D. A length of Sample, equivalent to one half, is then taken from before the loop, B, and after the loop, E. The second half of the Loop D is mixed with the with the Sample before the Loop B and the first half of the Loop C is mixed with the Sample after the Loop E. By Cross-Fading between the Samples a Waveform is created with equal mixes of both Samples at the Loop points, so that the transition into and out of the Loop is the same as around the Loop.

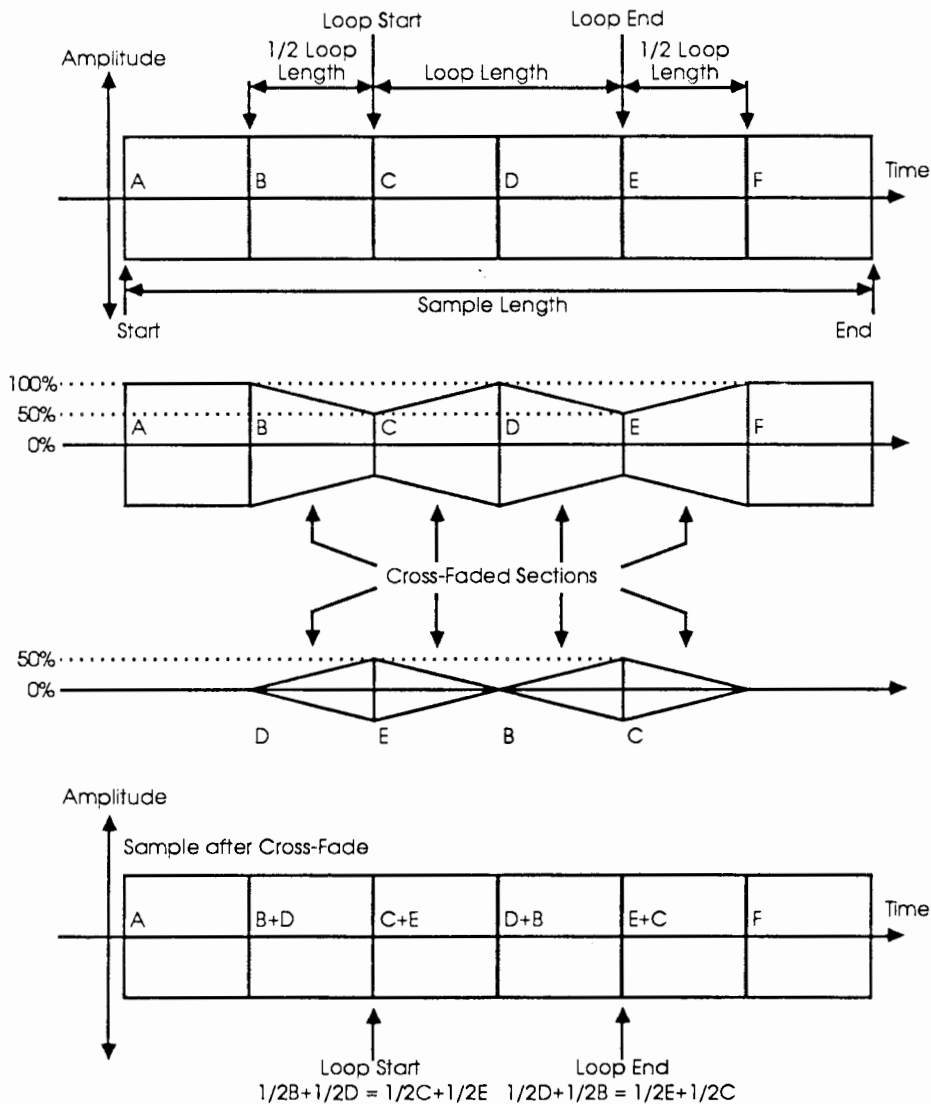

Cross-Fading provides a smoother Loop transition than simply Splicing the Loop.

Note that this operation will permanently effect the Sample, so you may wish to perform it on a copy, created using the **Save Sample As** option.

Click on the **X-Fade Loop** box to activate the function.

When you have created a satisfactory Loop you can close the Window by clicking **Accept**. Any changes made will be saved with the Sample.

Click **Quit** if you wish to close the Window but do not wish to save any changes made.

SPECIAL FUNCTIONS

A number of Special Sampler Functions are available from the Special Menu. Note that these operations will permanently effect the Sample, so you may wish to perform them on a copy, created using the **Save Sample As** option.

Clear Samples Not In Window

Choosing **Clear Samples Not In Window** from the Special Menu will set all of the Samples outside the Zoom Window to zero.

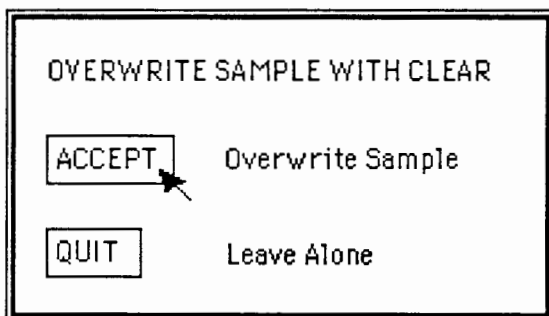

Since this operation overwrites the Sample, a Warning Window opens allowing you to cancel the operation by clicking **Quit**.

Reverse Samples In Window

Choosing **Reverse Samples In Window** from the Special Menu will reverse the Sample inside the Zoom Window.

You can use this function to create backward Drums or Cymbals. Before reversing the Sample, Truncate the end so that the reversed Sample plays immediately.

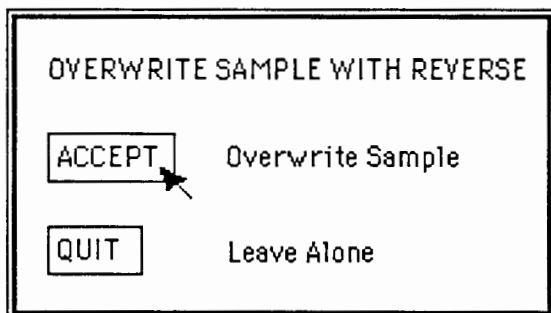

Since this operation overwrites the Sample, a Warning Window opens allowing you to cancel the operation by clicking **Quit**.

Maximise Sample Amplitude

Choosing **Maximise Sample Amplitude** from the Special Menu will digitally increase the gain of the whole Sample to the maximum level before clipping.

You can use this function to increase the Signal to Noise ratio of Samples which have been Sampled at too low a level. Since the operation is accomplished digitally there will be no noise added.

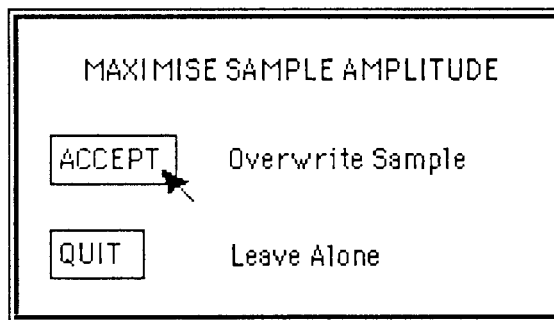

Before processing, a Warning Window opens allowing you to cancel the operation by clicking **Quit**.

UTILITY FUNCTIONS

A number of Functions are available from the **Utility Menu**. These are used to generate Test Waveforms and are of limited musical use.

Selecting **Sine** from the **Utility Menu** generates a Low-Frequency Sine Waveform for the selected Sample Length.

Selecting **Hi Ramp** from the **Utility Menu** generates a Ramp Waveform with maximum Amplitude for the selected Sample Length.

Selecting **Lo Ramp** from the **Utility Menu** generates a Ramp Waveform with minimum Amplitude for the selected Sample Length.

EDITING OTHER SAMPLES

Other Samples can be loaded into the Sampler Screen, allowing you view or Edit their Waveforms. When the Sample is loaded it will always be **Protected**, preventing any changes from being made until the Protection is turned off.

Edit Sample from Memory

Select **Edit Sample** from the **Memory** Menu to load a Sample from those currently in Memory. If you have not saved the current Sample, a **Save Changes Window** will appear :

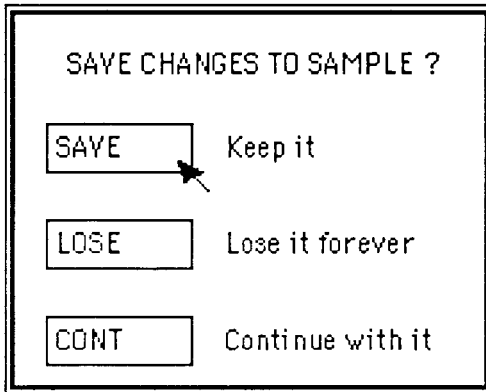

This gives you the option to **Save** the current Sample, **Lose** it forever, or cancel the Edit operation and **Continue** with the current Sample.

An **Edit Memory Sample Catalog** will now be displayed unless you cancelled the operation from the Save Changes Window.

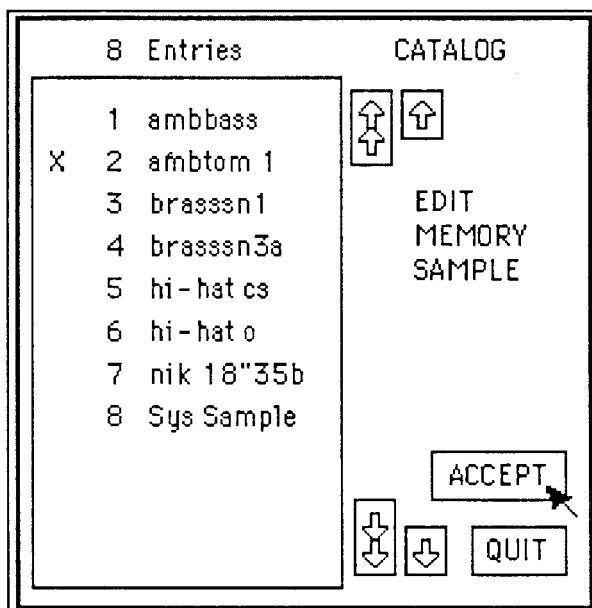

To select a Sample, click on it's Sample name. The Sample will be indicated with a cross. Click **Accept** to load it.

The selected Sample name will appear at the top of the Screen and it's Sample Waveform will be displayed in the Sample Window. The loaded Sample can be played back by striking the assigned Pad or clicking the right-hand Select Button.

Edit Sample from Disk

Samples can also be loaded from Disk by selecting **Edit Sample** from the **Disk** Menu. The selected Sample will be loaded into Memory and be assigned to the same Dynamic and Position as the Sample it replaces. The Sample chosen will not be loaded again if it already exists in Memory. If you have not saved the current Sample, the **Save Changes Window** will open as described above.

An **Edit Disk Sample Catalog** will now be displayed unless you cancelled the operation from the Save Changes Window.

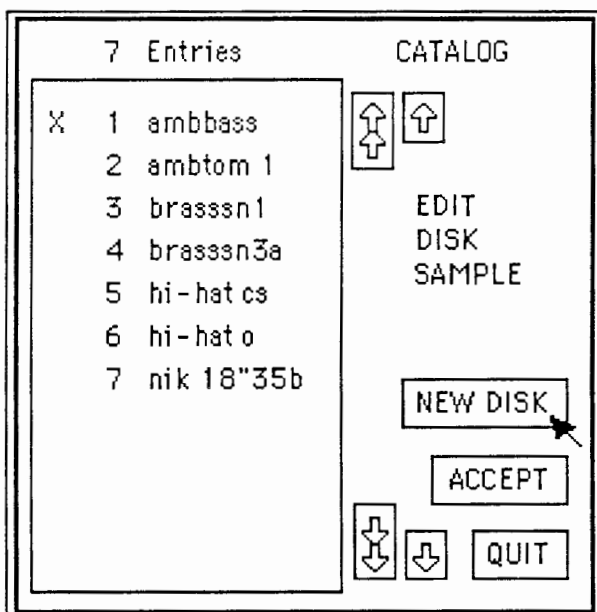

Select the Sample to be loaded from the Catalog and click **Accept** to load it.

The selected Sample name will appear at the top of the Screen and it's Waveform will be displayed in the Sample Window. The loaded Sample can be played back by striking the assigned Pad or clicking the right-hand Select Button.

Edit Sample from Sample Assign Screen

If you choose **Edit Sample** from the **Drum/Sample Assigning** Window, instead of **New Sample**, the Sampler Screen will be displayed with the Waveform of the currently assigned Sample. You can carry out any Edits to the Sample as described above, or load other Samples by selecting **Edit Sample** from the **Memory** or **Disk** Menus. When you leave the Sampler Screen the current Sample Name will be assigned on the Sample Assign Screen.

SAMPLE PROTECTION

When a Sample is loaded the **Protected** Indicator appears under the Zoom Window. This prevents any unwanted changes from being made to the Sample. You cannot access the **Scissors** icon while the Sample is Protected. Clicking on the Protected Indicator, opens the **Sample Protection Window**.



To turn off the Protection, click **Protection Off** followed by **Accept**. The Sample Protection Window can also be opened by selecting **Protection** from the **Special Menu**.

LEAVING THE SAMPLER SCREEN

Once you have finished working with the Sampler you can return to the Sample Assign Screen by selecting **Quit** from the **Next Menu**.

If you have edited the current Sample, but have not saved it, a **Save Changes Window** is displayed, as described above, before you can leave the Screen.

SAVE CHANGES TO SAMPLE ?

SAVE	Keep it
LOSE	Lose it forever
CONT	Continue with it

Save

To Save the Sample and any edits, click on the **Save** box.

If you have not already named the Sample an **Alphanumeric Keyboard Window** will appear, allowing you to give the new Sample an 11 character name.

If the name you have chosen already exists, the **Name Exists Window** will open. This gives you the option to **Rename** the new Sample, using the Alphanumeric Keyboard again, **Replace** the Sample with the same name, or **Quit** the **Save** operation.

Lose

If you don't want to keep the Sample, click on the **Lose** box. This frees the Memory space you allocated when you entered the Sampler, losing any Samples made. The Sample Assign Screen will now be displayed.

Cont

If you selected **Quit** from the **Next Menu** by mistake, or changed your mind about leaving the Sampler, you can cancel the Quit operation and continue, by clicking the **Cont** box.

Section 4.6

Using SDX: Disk Operations Window

CONTENTS

Other Disk Operations Window	4 - 101
Selecting the Current Device	4 - 102
Selecting the Disk Name	4 - 103
Load Operations	4 - 104
Load One	4 - 104
Load All	4 - 105
Save Operations	4 - 106
Save One	4 - 106
Save All	4 - 107
Delete Operations	4 - 108
Delete One	4 - 108
Delete All	4 - 109
Rename Operation	4 - 111
Rename One	4 - 111
Format Operation	4 - 113
Formatting a Disk	4 - 114
Copy Operations	4 - 116
Copy Options	4 - 116
Copy One	4 - 117
Copy All	4 - 119

OTHER DISK OPERATIONS WINDOW

By now you should have used the **Disk Menu** to Load and Save Kits, Drums and Samples to and from the other Screens. When using this menu you may have noticed the title **Other** among the choices.

This selection opens the **Other Disk Operations** Window. Point to the **Disk** box on any Screen, then press and hold the Select Button. The Disk Menu appears. Roll the Tracker Ball downwards to **Other** and release the Select Button.

The **Other Disk Operations** Window will open :

OTHER DISK OPERATIONS			
Current Device : Int Floppy Disk Name : AMBIENT 1			
OPERATION	QUANTITY	ITEM TYPE	
<input type="checkbox"/> Load	<input type="checkbox"/> One	<input type="checkbox"/> Sample	<input type="button" value="ACCEPT"/> <input type="button" value="QUIT"/>
<input type="checkbox"/> Save	<input type="checkbox"/> All	<input type="checkbox"/> Drum	
<input type="checkbox"/> Delete		<input type="checkbox"/> Kit	
<input type="checkbox"/> Rename		<input type="checkbox"/> Chain	
		<input type="checkbox"/> Sequence	
		<input type="checkbox"/> Other	
<input type="checkbox"/> Format			
<input type="checkbox"/> Copy			

This Window allows you to **Load, Save, Delete** or **Copy** one or all, of the specified items from **any** of SDX's Screens. You can also **Rename** an item and **Format** Disks.

SELECTING THE CURRENT DEVICE

Load, Save, Delete, Rename and **Format** Operations are all performed on the Current Device. The Device can be the Internal Floppy, an Internal Hard Disk or External Devices connected to the SCSI port.

To select the Current Device, click on the Device Name. A **Device Select Catalog** will appear :

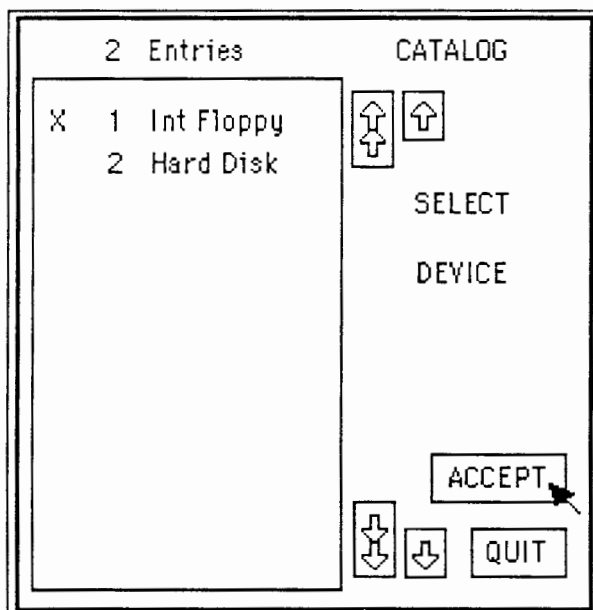

If you do not have internal or external Hard Disks, only one Device will be displayed, the **Internal Floppy**.

If an internal Hard Disk has been fitted, two Devices will be displayed, the **Internal Floppy** and the **Internal Hard Disk**, SCSI 0.

Any other Devices connected to the SCSI port will be displayed with their address number. Consult the **Interface** Section on **SCSI** for further details.

To select a different Device click on it's name. The entry will be marked with a cross. Click **Accept** to select this Device.

The Device Name will now be displayed on the **Disk Operations** Window and all operations will be performed on its Disk.

SELECTING THE DISK NAME

The Name of the Disk in the Current Device is displayed under the Device Name.

When the Current Device is the **Internal Floppy** there can only be one **Disk Name**, that of the Disk in the Drive. However, if you have a Hard Disk fitted it can be divided into a maximum of 30 **Disk Slots**. Each Disk Slot can be given a unique Disk Name.

To select the Disk Slot, click on the Disk Name. A **Disk Slot Catalog** will appear :

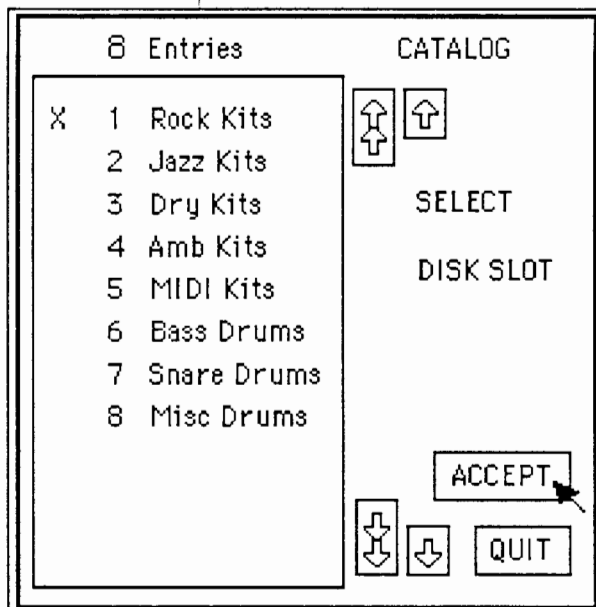

If you do not have internal or external Hard Disks, only one Disk Name will be displayed, the one in the **Internal Floppy**.

If an internal Hard Disk has been fitted and it has been selected as the Current Device, the Names of it's Disk Slots will be displayed.

To select a different Disk Slot click on it's name. The entry will be marked with a cross. Click **Accept** to select this Disk.

The Disk Name will now be displayed on the **Disk Operations** Window and all operations will be performed on this Disk.

LOAD OPERATIONS

This operation allows you to Load **one of each** of the selected **Sample, Drum, Kit, Chain, Sequence** and **Other** items from the Current Disk.

Alternatively, you can Load **all of each** of the selected **Sample, Drum, Kit, Chain, Sequence** and **Other** items from the Disk.

Load One

To Load one of each type, click **Load**, then **One**, then each **Type** you require. Each click will cause an indicator to appear next to the name. To de-select a Type, click it's name again.

OTHER DISK OPERATIONS			
Current Device : Int Floppy Disk Name : AMBIENT 1			
OPERATION	QUANTITY	ITEM TYPE	
(o) Load	(o) One	(o) Sample	ACCEPT QUIT
() Save	() All	() Drum	
() Delete		() Kit	
() Rename		() Chain	
		() Sequence	
		() Other	
() Format			
() Copy			

To change your selection, simply click another item type. Or, if you wish to abandon the operation click **Quit** to cancel and close the Window.

When you have made your selection click **Accept**.

- A **Load Disk Catalog** will appear allowing you to select the item to be Loaded.
- From the Catalog, click on the item name you require, then click **Accept** to Load it.
- A **Loading ... Please Wait** message will appear while the Drive is active.

If you have chosen more than one type, this process will be repeated for each type.

When the operation is finished the **Other Disk Operations** Window will be displayed again. The new items will now be in Memory.

Note When Kits are loaded, all the Drums and Samples assigned to each Kit are also loaded. When Drums are loaded all the Samples assigned to each Drum will also be loaded. If a Kit, Drum, or Sample is already in Memory it will not be loaded again.

Load All

To Load all of each Type, click **Load**, then **All**, then each **Type** you require. Each click will cause an indicator to appear next to the name. To de-select a Type, click it's name again.

When you have made your selection click **Accept**.

OTHER DISK OPERATIONS			
Current Device : Int Floppy Disk Name : AMBIENT 1			
OPERATION	QUANTITY	ITEM TYPE	
<input checked="" type="checkbox"/> Load	<input type="checkbox"/> One	<input type="checkbox"/> Sample	
<input type="checkbox"/> Save	<input checked="" type="checkbox"/> All	<input checked="" type="checkbox"/> Drum	
<input type="checkbox"/> Delete		<input type="checkbox"/> Kit	ACCEPT
<input type="checkbox"/> Rename		<input type="checkbox"/> Chain	
		<input type="checkbox"/> Sequence	QUIT
		<input type="checkbox"/> Other	
<input type="checkbox"/> Format			
<input type="checkbox"/> Copy			

A **Loading All ... Please Wait** message will appear while the Drive is active. If you have selected more than one type, a Loading Message will be displayed for each type as it is Loaded. When the operation is finished the **Other Disk Operations** Window will be displayed again. The new items will now be in Memory.

SAVE OPERATIONS

This operation allows you to Save **one of each** of the selected **Sample, Drum, Kit, Chain, Sequence** and **Other** items from Memory to the Current Disk.

Alternatively, you can Save **all of each** of the selected **Sample, Drum, Kit, Chain, Sequence** and **Other** items, provided you have enough space on the Disk.

You must have an **Unprotected** Disk in the Drive.

Save One

To Save one of each type, click **Save**, then **One**, then each **Type** you require. Each click will cause an indicator to appear next to the name. To de-select a Type, click it's name again.

OTHER DISK OPERATIONS			
Current Device : Int Floppy Disk Name : AMBIENT 1			
OPERATION	QUANTITY	ITEM TYPE	
<input type="checkbox"/> Load	<input checked="" type="radio"/> One	<input type="checkbox"/> Sample	<input type="button" value="ACCEPT"/> <input type="button" value="QUIT"/>
<input checked="" type="checkbox"/> Save	<input type="checkbox"/> All	<input type="checkbox"/> Drum	
<input type="checkbox"/> Delete		<input checked="" type="radio"/> Kit	
<input type="checkbox"/> Rename		<input type="checkbox"/> Chain	
		<input type="checkbox"/> Sequence	
		<input type="checkbox"/> Other	
<input type="checkbox"/> Format			
<input type="checkbox"/> Copy			

To change your selection, simply click another item type. Or, if you wish to abandon the operation click **Quit** to cancel and close the Window.

When you have made your selection click **Accept**.

- A **Save Memory Catalog** will open allowing you to select the item to be Saved.
- From the Catalog, click on the item name you require, then click **Accept** to Save it.
- A **Saving ... Please Wait** message will appear while the Drive is active.

If you have chosen more than one type, this process will be repeated for each type.

Disk Operations

When the operation is finished the **Other Disk Operations** Window will be displayed again. The items will now be on the Current Disk.

Note When Kits are Saved, all the Drums and Samples assigned to each Kit are also Saved. When Drums are Saved all the Samples assigned to each Drum will also be Saved. If a Kit, Drum, or Sample is already on the Current Disk it will not be Saved again.

Save All

To Save all of each type, click **Save**, then **All**, then each **Type** you require. Each click will cause an indicator to appear next to the name. To de-select a Type, click it's name again.

OTHER DISK OPERATIONS			
Current Device : Int Floppy Disk Name : AMBIENT 1			
OPERATION	QUANTITY	ITEM TYPE	
<input type="checkbox"/> Load	<input type="checkbox"/> One	<input checked="" type="checkbox"/> Sample	<input type="button" value="ACCEPT"/> <input type="button" value="QUIT"/>
<input checked="" type="checkbox"/> Save	<input checked="" type="checkbox"/> All	<input type="checkbox"/> Drum	
<input type="checkbox"/> Delete		<input type="checkbox"/> Kit	
<input type="checkbox"/> Rename		<input type="checkbox"/> Chain	
		<input type="checkbox"/> Sequence	
		<input type="checkbox"/> Other	
<input type="checkbox"/> Format			
<input type="checkbox"/> Copy			

When you have made your selection click **Accept**.

A **Saving All ... Please Wait** message will appear while the Drive is active. If you have selected more than one type, a Saving Message will be displayed for each type as it is Saved. When the operation is finished the **Other Disk Operations** Window will be displayed again. The new items will now be on the Current Disk.

DELETE OPERATIONS

This operation allows you to Delete **one of each** of the selected **Sample, Drum, Kit, Chain, Sequence** and **Other** items from the Current Disk.

Alternatively, you can Delete **all of each** of the selected **Sample, Drum, Kit, Chain, Sequence** and **Other** items from the Disk.

You must have an **Unprotected** Disk in the Drive.

Delete One

To Delete one of each type, click **Delete**, then **One**, then each **Type** you require. Each click will cause an indicator to appear next to the name.

To de-select a Type, click it's name again.

OTHER DISK OPERATIONS			
Current Device : Int Floppy Disk Name : AMBIENT 1			
OPERATION	QUANTITY	ITEM TYPE	
<input type="checkbox"/> Load	<input checked="" type="radio"/> One	<input type="checkbox"/> Sample	<input type="button" value="ACCEPT"/> <input type="button" value="QUIT"/>
<input type="checkbox"/> Save	<input type="checkbox"/> All	<input checked="" type="radio"/> Drum	
<input checked="" type="radio"/> Delete		<input type="checkbox"/> Kit	
<input type="checkbox"/> Rename		<input type="checkbox"/> Chain	
		<input type="checkbox"/> Sequence	
		<input type="checkbox"/> Other	
<input type="checkbox"/> Format			
<input type="checkbox"/> Copy			

To change your selection, simply click another item type. Or, if you wish to abandon the operation click **Quit** to cancel and close the Window.

When you have made your selection click **Accept**.

- A **Delete Disk Catalog** will open allowing you to select the item to be Deleted.
- From the Catalog, click on the item name you require, then click **Accept** to Delete it.

- A **Delete Warning Window** will appear. This gives you the option to cancel the Delete operation before the item is removed forever !

DELETE DRUM ?

Go Ahead, Delete

Don't Delete

- Click **Accept** if you wish to go ahead with the Delete operation.
- A Deleting Please Wait message will appear while the Drive is active.

If you have chosen more than one type, this process will be repeated for each type.

When the operation is finished the **Other Disk Operations** Window will be displayed again. The selected items have been removed from the Current Disk.

Delete All

To Delete all of each type, click **Delete**, then **All**, then each **Type** you require. Each click will cause an indicator to appear next to the name.

To de-select a Type, click it's name again.

OTHER DISK OPERATIONS

Current Device : Int Floppy		
Disk Name : AMBIENT 1		
OPERATION <input type="checkbox"/> Load <input type="checkbox"/> Save <input checked="" type="checkbox"/> Delete <input type="checkbox"/> Rename <input type="checkbox"/> Format <input type="checkbox"/> Copy	QUANTITY <input type="checkbox"/> One <input checked="" type="checkbox"/> All	ITEM TYPE <input type="checkbox"/> Sample <input type="checkbox"/> Drum <input checked="" type="checkbox"/> Kit <input type="checkbox"/> Chain <input type="checkbox"/> Sequence <input type="checkbox"/> Other
		<input type="button" value="ACCEPT"/> <input type="button" value="QUIT"/>

When you have made your selection click **Accept**.

A **Delete Warning Window** will appear. This gives you the option to cancel the Delete operation before the items are removed forever!

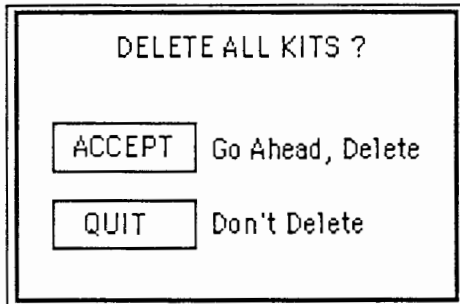

Click **Accept** if you wish to go ahead with the Delete operation.

A **Deleting All ... Please Wait** message will appear while the Drive is active. If you have selected more than one type, a Delete Warning will be displayed for each type, giving you the chance to **Quit** each selection.

When the operation is finished the **Other Disk Operations** Window will be displayed again. The items have been removed from the Current Disk.

RENAME OPERATION

This operation allows you to Rename **one of each** of the selected **Sample, Drum, Kit, Chain, Sequence** and **Other** items on the Current Disk.

You must have an **Unprotected** Disk in the Drive.

Rename One

To Rename an item, click **Rename**, then the **Type** you require. Each click will cause an indicator to appear next to the name. You cannot Rename **All**, so the option is not displayed and you cannot select more than one type, so the indicator shows only the last choice.

OTHER DISK OPERATIONS			
Current Device : Int Floppy Disk Name : AMBIENT 1			
OPERATION	QUANTITY	ITEM TYPE	
<input type="checkbox"/> Load	<input checked="" type="radio"/> One	<input type="checkbox"/> Sample	
<input type="checkbox"/> Save		<input type="checkbox"/> Drum	
<input type="checkbox"/> Delete		<input checked="" type="radio"/> Kit	
<input checked="" type="radio"/> Rename		<input type="checkbox"/> Chain	
		<input type="checkbox"/> Sequence	
		<input type="checkbox"/> Other	
<input type="checkbox"/> Format			<input type="button" value="ACCEPT"/>
<input type="checkbox"/> Copy			<input type="button" value="QUIT"/>

To change your selection, simply click another item type. Or, if you wish to abandon the operation click **Quit** to cancel and close the Window.

When you have made your selection click **Accept**.

- A **Rename Disk Catalog** will open allowing you to select the item to be Renamed.
- From the Catalog, click on the item name you require, then click **Accept** to Rename it.

Creative Use of SDX

- An **Alphanumeric Keyboard** Window will appear. This allows you to enter an alternative 11 character name for the selected item.

New Name : Snare

ACCEPT QUIT

1 2 3 4 5 6 7 8 9 0 - = " Del

q w e r t y u i o p [] { }

caps a s d f g h j k l ; ' caps

z x c v b n m , . / \

CLEAR

bass snare rim tom hihat symbal LAST NAME

Click on the letter or numbers in sequence. Click **Del** to backspace or **Clear** to clear the entry. Common Drum names and the **Last Name** entered are also available and a typed when clicked.

Upper case letters can be selected by clicking **Caps**. If you want to change your entry you can point to any character in the name and re-enter another letter or number.

To cancel the Rename operation click **Quit**.

- Click **Accept** if you wish to go ahead with the Rename operation.
- The Drive will become active while the item is Renamed.

When the operation is finished the **Other Disk Operations** Window will be displayed again. The selected item has been renamed on the Current Disk.

If the name you have entered already exists on the Current Disk, a **Name Exists Window** will open.

This gives you the option to **Rename** the item again, using the Alphanumeric Keyboard Window, **Replace** the item, overwriting the same name, or **Quit** the Rename operation.

FORMAT OPERATION

When you buy new, blank Disks they must be **Formatted** before you can store information on them. This process forms **Magnetic Tracks** on the Disk, similar to grooves in a Record, only they are not cut into the surface. By splitting the Disk into **Sectors**, like slices of cake, each Track within a Sector, called a **Block**, can be given a unique address. Using these addresses SDX can keep a **Directory** of where it saves information on the Disk. The contents of this Directory are displayed when you select **Info** from the **Disk Menu**.

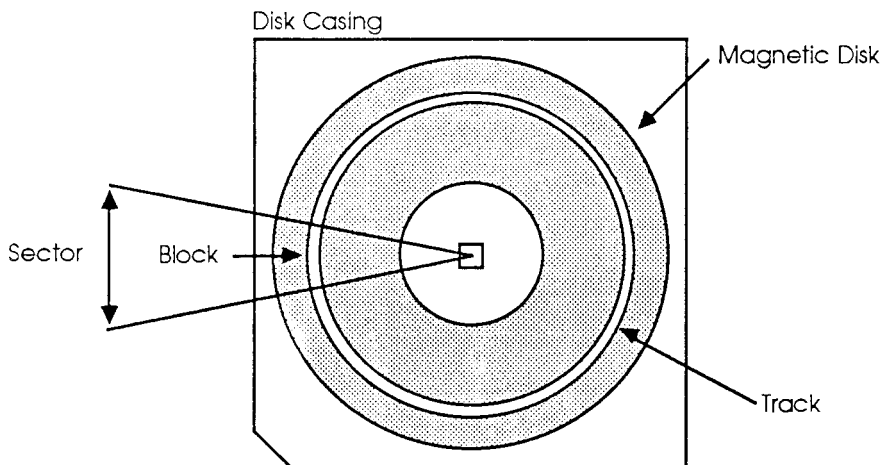

Once a Disk has been Formatted, space is taken up by the Directory and its addresses, the remainder is free to store your information. For example a formatted 1 MegaByte Disk will have 633 KiloBytes of free storage area.

Formatting is only required once, on a new blank Disk. You can re-format old SDX Disks or Disks which have been used in other instruments or computers, but this will bulk erase **all** of the previous information on the Disk. The Format operation should therefore be used with care.

SDX can Format two types of 3.5" Micro-Floppy Disk

- **1 MByte DS/DD (Double-Sided / Double-Density), 135 TPI.**
1 MegaByte Disks are normally used to hold the SDX Operating Software. You can use them as Sound Disks but, once formatted, will be limited to 633 KiloBytes of storage area.
- **2 MByte DS/HD (Double-Sided / High-Density), 135 TPI.**
2 MegaByte Disks are normally used as Sound Disks to contain Kits, Drums and Samples. Once formatted they will have 1,273 KiloBytes of storage area free.

SDX will automatically select between the two types by detecting the extra hole in the casing of the 2 MegaByte Disk. Use the Disk Information Window to check the size and free space on any Disk.

Formatting a Disk

To Format a Disk, click **Format**, an indicator will appear next to the name. You cannot have a Quantity or Type, so the options are not displayed

OTHER DISK OPERATIONS		
Current Device : Int Floppy Disk Name : AMBIENT 1		
OPERATION	QUANTITY	ITEM TYPE
() Load	(o) All	(o) Disk
() Save		
() Delete		
() Rename		
(o) Format		
() Copy		
		ACCEPT
		QUIT

If you wish to abandon the operation click **Quit** to cancel and close the Window. To continue, click **Accept**.

- A **Format Warning** will appear allowing you cancel the operation. Click **Accept** to continue.
- A second **Format Warning** will appear giving you another chance to cancel the operation. Click **Accept** to continue.
- An **Alphanumeric Keyboard** Window will appear. This allows you to enter an 11 character name for the Disk.

Disk Name : Rock Kits											ACCEPT	QUIT	
1	2	3	4	5	6	7	8	9	0	-	=	"	Del
q	w	e	r	t	y	u	i	o	p	[]	{	}
caps	a	s	d	f	g	h	j	k	l	:	'	caps	
	z	x	c	v	b	n	m	,	.	/	\		
											CLEAR		
bass	snare	rim	tom	hihat	symbal	LAST NAME							

- 4 - 114 When the current Disk is a Floppy, the Format option will not have a Quantity or Item Type. For a Hard Disk there will be a Quantity. **One** to Format a Disk Slot and **All** to Format the Disk.
- 4 - 125 Only Program Changes are displayed in MDI/Watch.

Click on the letter or numbers in sequence. Click **Del** to backspace or **Clear** to clear the entry. Upper case letters can be selected by clicking **Caps**. If you want to change your entry you can point to any character in the name and re-enter another letter or number.

You also have one last chance to cancel the Format operation by clicking **Quit**.

Click **Accept** if you wish to go ahead with the Format operation.

- A **Formatting Disk ... Please Wait** message will appear and the Drive will become active while the Disk is Formatted.

The current **Side**, 0 or 1, and the current **Track**, 0 to 79, will be displayed in the message Window.

- When the operation is finished, the number of good and bad Blocks counted will be displayed. Each Block holds 1 KiloByte of information. If any Bad Blocks have been encountered, try re-formatting the Disk. If a new Disk is consistently bad, return it to the supplier. If an old Disk shows bad, bin it !
- Click to return to the **Other Disk Operations** Window.

COPY OPERATIONS

This operation allows you to Copy **one of each** of the selected **Sample, Drum, Kit, Chain, Sequence** and **Other** items from the Current Device to a Destination Device.

Alternatively, you can Copy **all of each** of the selected **Sample, Drum, Kit, Chain, Sequence** and **Other** items, provided you have enough space on the Destination Disk.

If you are copying to and from Floppy, you should **Protect** the Source Disk and **Unprotect** the Destination Disk.

Copy Options

When you select **Copy**, several new options appear in the Window :

- **Source Device**
Current Device has changed to Source Device. This is the Device which you will be copying **from**.
- **Destination Device**
This is the Device which you will be copying **to**. The Device and Disk Name are selected in the same way as the Current Device and Disk Name.
- **Format First**
This option allows you to Format the Destination Disk before any information is copied to it. This will save you work if you are making Backups of your Sound Disks since you can Format and Copy in one Operation. However, if the Destination Disk is not a newblank Disk all previous information on the Disk will be erased.
- **Warning if Exists**
You can ask SDX to produce a Warning Message if an item name you are copying already exists on the Destination Disk. You will then have the option to overwrite the item or leave it alone.
- **Erase After**
SDX uses its Memory to hold all the items to be copied while it is transferring information between the Devices. If you do not want these items to remain in Memory after the operation, click this option.

Copy One

To Copy one of each type, click **Copy**, then **One**, then each **Type** you require. Each click will cause an indicator to appear next to the name. To de-select a Type, click it's name again.

OTHER DISK OPERATIONS			
Source Device : Int Floppy Disk Name : AMBIENT 1		Destination Device : Int Floppy	
OPERATION	QUANTITY	ITEM TYPE	() Warning if Exists
() Load	(o) One	(o) Sample	(o) Erase After
() Save	() All	(o) Drum	
() Delete		(o) Kit	
() Rename		() Chain	
		() Sequence	
		() Other	
() Format First			ACCEPT
(o) Copy			QUIT

Select the required **Source** and **Destination** Devices and click the **Copy Options** which you require.

If you wish to abandon the operation click **Quit** to cancel and close the Window.

When you have made your selection click **Accept**.

- A **Load Disk Catalog** will open allowing you to select the item to be Copied from the Source Device.
- From the Catalog, click on the item name you require, then click **Accept** to Copy it.
- A **Loading ...** message will appear at the top of the Window while the Drive is active.

If you have chosen more than one type, this process will be repeated for each type.

If the Source and Destination Devices are both the Internal Floppy Drive an **Insert New Disk** Window appears :

INSERT NEW DISK	
ACCEPT	Go Ahead, Copy
QUIT	Don't Copy

You should now remove the Disk that you have copied **from** and insert the Disk which you wish to copy **to**, making sure that it is **Unprotected**.

- If you wish to cancel the operation click **Quit**.
- Click **Accept** to Copy the information to the new Disk.

If you had selected the **Format First** option a **Format Warning Window** will appear. This gives you one last chance to cancel the operation before the Destination Disk is formatted and all it's previous information erased.

- Click **Accept** to Format the Disk.
- The Drive will become active while the Disk is formatted.

If the Format Option has not been selected the items will be added to the contents of the Destination Disk, provided there is enough room on the Disk.

- A **Saving ...** message will appear at the top of the Window while the items are copied to the Disk.

When the operation is finished the **Other Disk Operations** Window will be displayed again. The selected items will now be on the Destination Disk.

Note When Kits are Copied, all the Drums and Samples assigned to each Kit are also Copied. When Drums are Copied all the Samples assigned to each Drum will also be Copied. If a Kit, Drum, or Sample is already on the Destination Disk it will not be Copied again.

Copy All

To Copy all of each type, click **Copy**, then **All**, then each **Type** you require. Each click will cause an indicator to appear next to the name. To de-select a Type, click it's name again.

Select the required **Source** and **Destination** Devices and click the **Copy Options** which you require.

OTHER DISK OPERATIONS			
Source Device : Int Floppy Disk Name : AMBIENT 1		Destination Device : Int Floppy	
OPERATION	QUANTITY	ITEM TYPE	() Warning if Exists
() Load	() One	(o) Sample	(o) Erase After
() Save	(o) All	() Drum	
() Delete		() Kit	
() Rename		() Chain	
		() Sequence	
		() Other	
() Format First			ACCEPT
(o) Copy			QUIT

If you wish to abandon the operation click **Quit** to cancel and close the Window.

When you have made your selection click **Accept**.

- A **Loading ...** message will appear at the top of the Window while the items are copied from the Source Disk into Memory.
- If the Source and Destination Devices are both the Internal Floppy Drive the **Insert New Disk** Window appears.

You should now remove the Source Disk that you have copied **from** and insert the Destination Disk which you wish to copy **to**, making sure that it is **Unprotected**.

- If you wish to cancel the operation click **Quit**.
- Click **Accept** to Copy the information to the new Disk.

If you had selected the **Format First** option a **Format Warning Window** will appear. This gives you one last chance to cancel the operation before the Destination Disk is formatted and all it's previous information erased.

- Click **Accept** to Format the Destination Disk.

- The Drive will become active while the Disk is formatted.

If the Format Option has not been selected the items will be added to the contents of the Destination Disk, provided there is enough room on the Disk.

- A **Saving ...** message will appear at the top of the Window while the items are copied from Memory to the Destination Disk.

When the operation is finished the **Other Disk Operations** Window will be displayed again. The selected items will now be on the Destination Disk.

Note When Kits are Copied, all the Drums and Samples assigned to each Kit are also Copied. When Drums are Copied all the Samples assigned to each Drum will also be Copied. If a Kit, Drum, or Sample is already on the Destination Disk it will not be Copied again.

Section 4.7

Using SDX: Control Panel Window

CONTENTS

Control Panel	4 - 121
Damp dt	4 - 122
Damp pt	4 - 122
Damper	4 - 122
Hat	4 - 122
Mod	4 - 122
Quit	4 - 122
AutoTrigger	4 - 123
Dynamic	4 - 124
Position	4 - 124
Tempo	4 - 124
Last Dyn	4 - 124
Last Pos	4 - 124
Clear	4 - 124
Start/Stop	4 - 124
Quit	4 - 124
MidiWatch	4 - 125
MIDIWatch	4 - 125
Quit	4 - 125
Key Pad Mode	4 - 125
Key Pad Modes	4 - 126
Mode 1	4 - 126
Mode 2	4 - 127
Mode 3	4 - 127
Mode 4	4 - 127
Mode 5	4 - 127
C. Panel	4 - 127
Quit	4 - 127

Control Panel

Every Screen has a Title box which displays a Menu when selected. This Menu would normally be used to select **Info on ...** allowing access the Help System Windows for each Screen. However, the last choice on the Menu of each Title box invokes the **Control Panel**.

Point to the Title box on any Screen, then press and hold the Select Button. A Menu appears under the Title box. Roll the Tracker Ball downwards to **Control Panel** and release the Select Button.

The **Control Panel Window** will open :

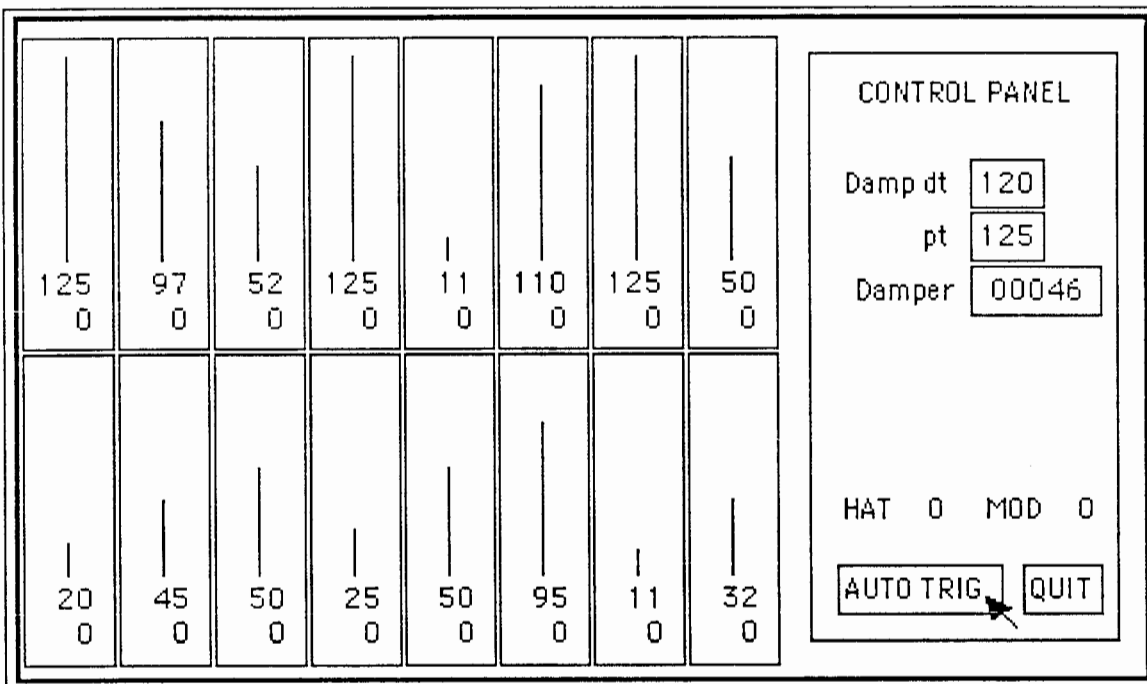

This Window allows access to the **16 Dynamic Meters**, **AutoTrigger**, **KeyPad Modes** and **MIDIWatch** Facility.

CONTROL PANEL

The **Control Panel** allows you to view the status of the 16 Pad Inputs. Each rectangle is a Dynamic Meter which indicates where and how hard any Pad was struck.

When you stike any of the 16 Drum Pads a line within the meter shows the Dynamic level graphically. The Dynamic value is also displayed, as a number, under each line. Positional values are displayed under the Dynamic values.

Dynamic and Positional values can range from 0 to 127.

You can also trigger an individual Pad by placing the Pointer anywhere on it's Dynamic Meter and clicking the left-hand Select Button. The Pad will be triggered with full Dynamic level with the Positional value set to zero.

Damp dt

This parameter adjusts the **Damp Dynamic Threshold** for the Symbols. It allows you to set a Dynamic value, below which the Symbol Voice will be Damped.

Point to the numeric box, press and hold the left-hand Select Button then roll the Tracker Ball upwards to increase the value or downwards to decrease it.

The value can range from 1 to 127, the default value being 120.

Damp pt

This parameter adjusts the **Damp Position Threshold** for the Symbols. It allows you to set a Position on the Symbol Pad which, when touched, will cause the Symbol Voice will be Damped.

Point to the numeric box, press and hold the left-hand Select Button then roll the Tracker Ball upwards to increase the value or downwards to decrease it.

The value can range from 1 to 127, the default value being 125.

Damper

The **Damper** value controls how quickly the Symbol Voice will be Damped, or Choked.

Point to the numeric box, press and hold the left-hand Select Button then roll the Tracker Ball upwards to increase the value or downwards to decrease it.

The value can range from -32767 to +32767, the default value being 00046.

Hat

The **Hat** parameter shows the current value of the Hi-Hat Pedal. This value can range from 0 to 127.

Mod

The **Mod** parameter shows the current value of the Modulation Pedal. This value can range from 0 to 127.

Quit

Clicking on the **Quit** box closes the Control Panel Window and returns to whatever Screen the Window was invoked from.

Auto Trig

Clicking on the **Auto Trig** box displays the AutoTrigger Window.

AUTOTRIGGER

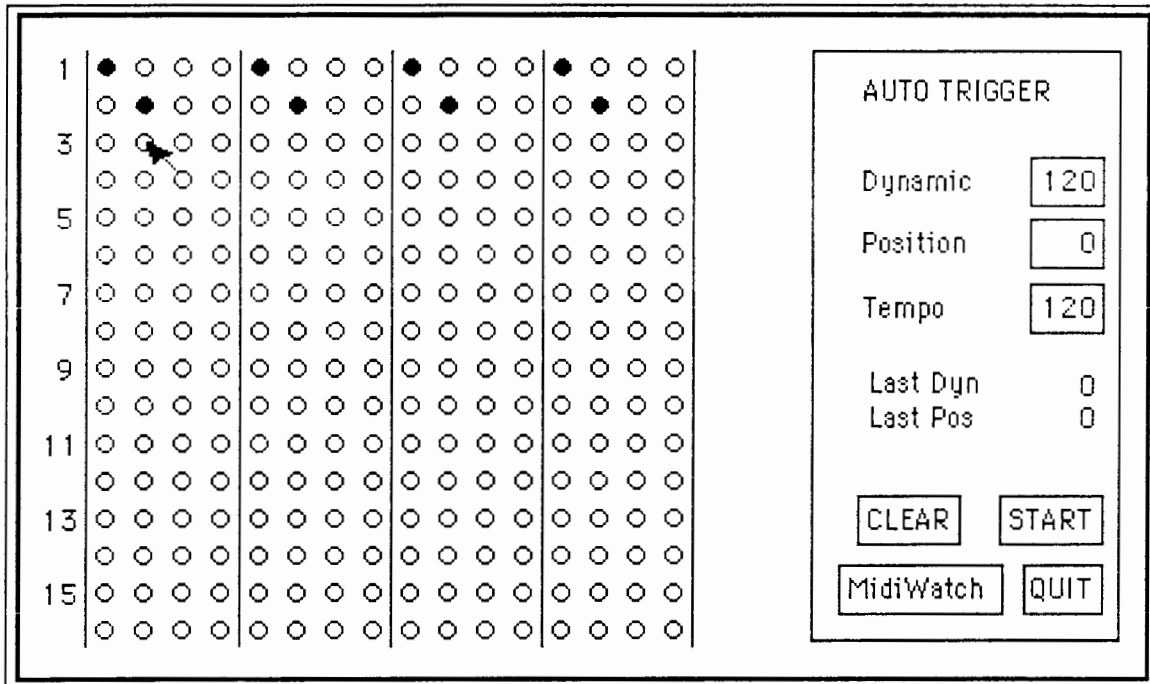

This part of the Control Panel is normally used to test SDX's voices being used to trigger any of the 16 pads without having to hit the Drum Pads.

However, the Autotrigger can be used as a creative Scratchpad for rhythmic ideas, since it allows Dynamic and Positional 'Hits' to be programmed while the Autotrigger is running.

The Autotrigger is presented as a 16 by 16 grid. At each point in the grid, there is a Hit indicator. If there is a Hit programmed the circle will be filled and the Pad will be triggered.

There are 16 beats in each row of the grid and 16 rows, one for each Pad.

To enter a Hit simply click on the indicator. To remove the Hit click on the indicator again.

When the Autotrigger is running, arrows at the top and bottom of the grid indicate the current beat position.

Each Hit will have the current Dynamic and Position values, so you can change these while the Autotrigger is running, introducing more 'feel' into the rhythm.

Dynamic

The current Dynamic value can be adjusted to simulate different Hit weights.

Point to the numeric box, press and hold the left-hand Select Button then roll the Tracker Ball upwards to increase the value or downwards to decrease it.

The value can range from 8 to 120, the default value being 120.

Position

The current Position value can be adjusted to simulate a Hit from different areas of a Pad.

Point to the numeric box, press and hold the left-hand Select Button then roll the Tracker Ball upwards to increase the value or downwards to decrease it.

The value can range from 0 to 120, the default value being 0.

Tempo

The **Tempo** of the Autotrigger can be adjusted in beats per minute. Each beat being one position on the grid.

Point to the numeric box, press and hold the left-hand Select Button then roll the Tracker Ball upwards to increase the value or downwards to decrease it.

The value can range from 40 to 360, the default value being 120.

Last Dyn

When you remove a Hit the **Last Dynamic** value will be displayed. This allows you to enter the Hit again with the same value, or repeat it elsewhere.

Last Pos

When you remove a Hit the **Last Position** value will be displayed. This allows you to enter the Hit again with the same value, or repeat it elsewhere.

Clear

Clicking **Clear** will remove all Hits from the grid.

Start/Stop

Click on **Start** to run the Autotrigger. The box will now display **Stop**. Click **Stop** to stop the Autotrigger.

Quit

Clicking on the **Quit** box closes the Control Panel Window and returns to whatever Screen the Window was invoked from. If the Autotrigger is running it will continue even when the Window is closed. To stop it you will have to open the Window again and click **Stop**.

MidiWatch

Clicking on the **Midiwatch** box displays the MidiWatch Window.

MIDIWATCH

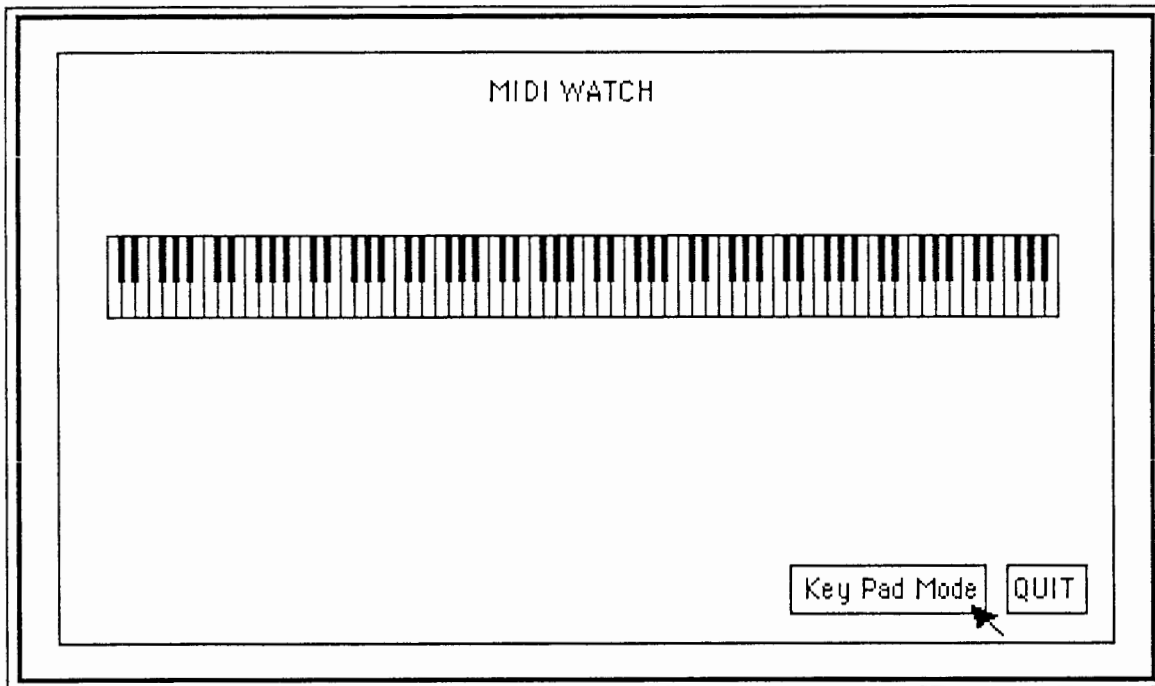

This facility allows you to view some of the MIDI data received at SDX's MIDI Input. A 10 Octave Music Keyboard is displayed in the Window. When MIDI Notes are received they will be indicated on the Keyboard. Their numeric and chromatic values are also displayed.

Program Changes and Control Changes will be displayed in numeric format below the Keyboard.

Quit

Clicking on the **Quit** box closes the Control Panel Window and returns to whatever Screen the Window was invoked from.

Key Pad Mode

Clicking on the **Key Pad Mode** box displays the Key Pad Mode Window.

KEY PAD MODES

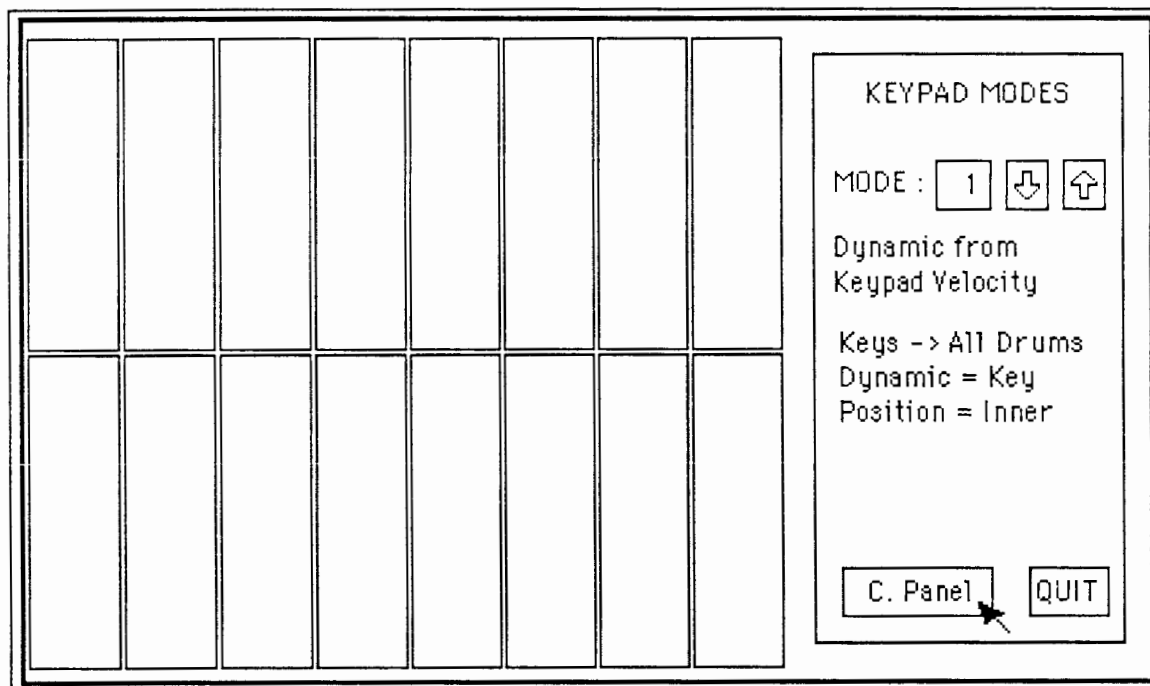

The **Key Pad** refers to the 16 Grey buttons on the SDX Console. You can change the function of these Pads by selecting a Key Pad Mode. The Dynamic Meters are also displayed.

To change the Key Pad Mode, point to the numeric box, press and hold the left-hand Select Button then roll the Tracker Ball upwards to increase the value, or downwards to decrease it. When you release the Select Button the new Mode selection will be displayed.

You can also single-step the Modes by clicking on the up or down Scroll arrows.

Mode 1 is the default mode and is selected on Power-up.

Mode 1

In Mode 1 the Pads can be used instead of, or as well as, the Kit Drum Pads. The harder they are hit, the higher the Dynamic value. The top 8 Pads trigger Drums 1 to 8, the bottom 8 trigger Drums 9 to 16.

- Dynamic from KeyPad Velocity
Keys - All Drums
Dynamic = Key
Position = Inner

Mode 2

In Mode 2 the Pads can still be used to play Drums, but they will always trigger the Drums with maximum Dynamic level, no matter how hard they are hit. The top 8 Pads trigger Drums 1 to 8, the bottom 8 trigger Drums 9 to 16.

- Fixed Dynamic
Keys - All Drums
Dynamic = Max (125)
Position = Inner

Mode 3

In Mode 3 the Pads no longer play the Drums, but allow any Kits which are loaded in Memory to be selected. The top 8 Pads select Kits 1 to 8, the bottom 8 select Kits 9 to 16. Hitting a Pad harder has no effect.

- KeyPad as a Selector Pad
Keys - Selector
Dynamic = Off
Position = Off

Mode 4

In Mode 4 the Pads only play the current Drum, but allow a range of Positions to be selected. All Pads are Dynamic, the harder they are hit, the higher the Dynamic value. The Pads select a Positional value ranging from 0 when the top left is hit, to 127 when the bottom right is hit.

- Current Drum, 16 Position (1)
Keys - 1 Drum
Dynamic = Key
Position = Range

Mode 5

In Mode 5 the Pads again play the current Drum, but allow a more limited range of Positions to be selected. All Pads are Dynamic, the harder they are hit, the higher the Dynamic value. The Pads select a Positional value ranging from 56 when the top left is hit, to 70 when the bottom right is hit.

- Current Drum, 16 Position (2)
Keys - 1 Drum
Dynamic = Key
Position = Range

C. Panel

Clicking on the **C. Panel** box displays the Control Panel Window again.

Quit

Clicking on the **Quit** box closes the Control Panel Window and returns to whatever Screen the Window was invoked from.

Section 5.1

Reference : Kit Select Screen

CONTENTS

Screen Parameters	5 - 1
Kit Icon	5 - 1
Active Kit	5 - 1
Kit Select Menu	5 - 2
Info on SDX	5 - 2
Info on Kit Select	5 - 2
Control Panel	5 - 2
Memory Menu	5 - 2
Delete Kit	5 - 2
Clear Memory	5 - 2
Info	5 - 2
Disk Menu	5 - 2
Save Kit	5 - 2
Load Kit	5 - 2
Load All Kits	5 - 2
Other	5 - 2
Info	5 - 3
Special Menu	5 - 3
Easy Sampling	5 - 3
Kit Edit Menu	5 - 3
Kit Mixer	5 - 3
Kit Configuration	5 - 3
Welcome	5 - 3

Creative Use of SDX

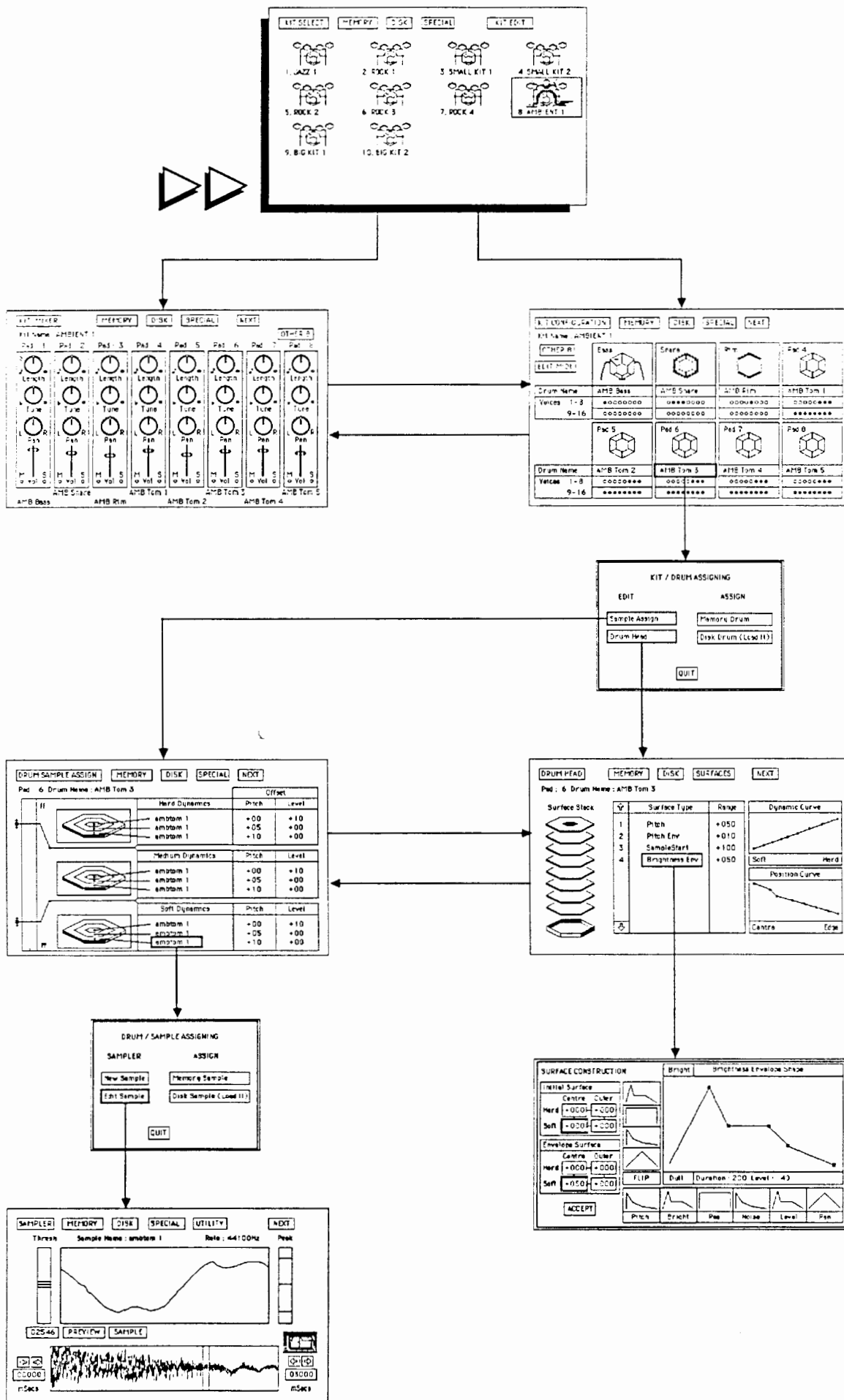

The Kit Select Screen allows any of the displayed Kits, which have been loaded from the Disk Drive, into Memory to be selected instantaneously. Kits can be selected using the Tracker Ball, Key Pads or the remote Footswitch.

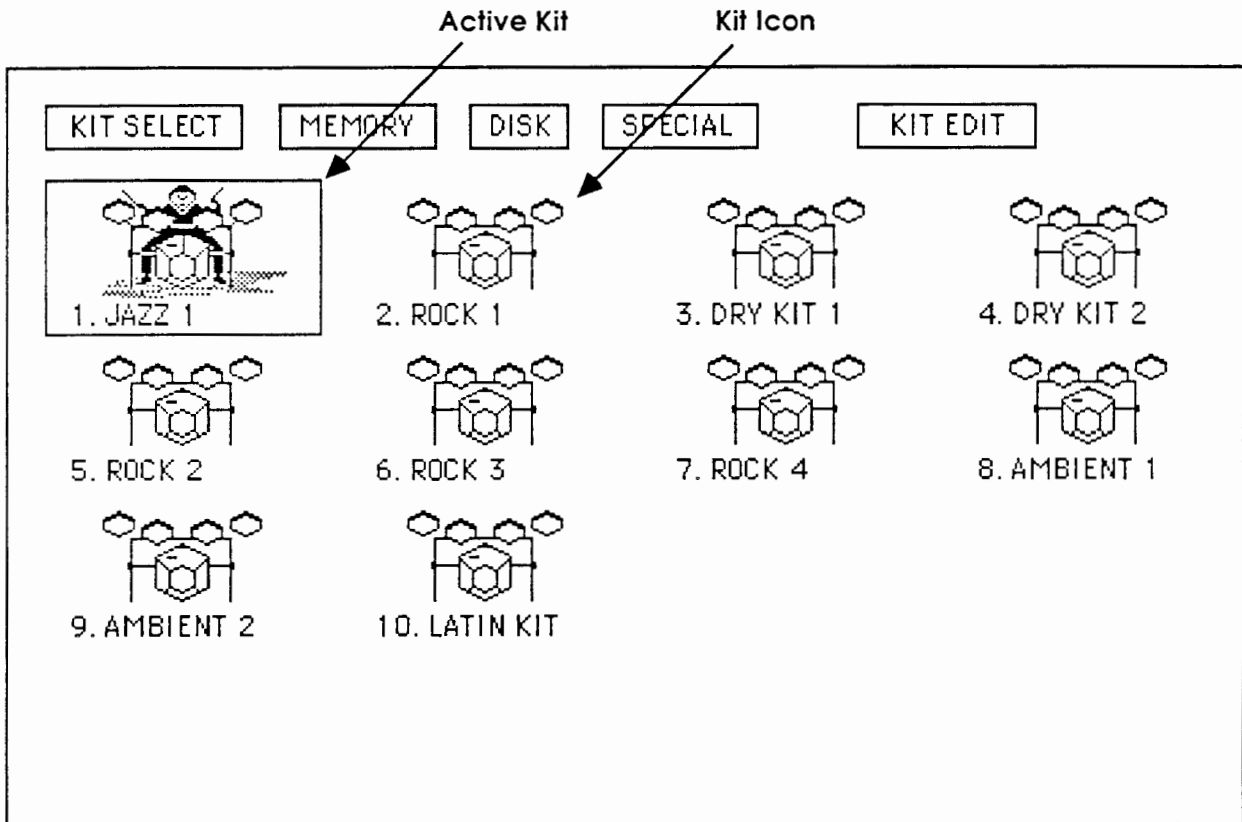

SCREEN PARAMETERS

Kit Icon

Kits loaded in Memory are displayed as **Kit Icons**. Up to sixteen can be displayed on the screen at any one time. The name and number of each Kit is shown beneath it's icon.

Active Kit

Clicking on any Kit will make that Kit **Active**. It can now be played on the Key or Kit Pads. To indicate it is active **Digit** appears behind the Kit, surrounded by a box.

KIT SELECT MENU



Info on SDX

Provides information about the SDX Console.

Info on Kit Select

Provides information about the Kit Select Screen.

Control Panel

Selects the **Control Panel Window** allowing access to the 16 Pad Dynamic Meters, AutoTrigger, Key Pad modes and MIDIWatch facility.

MEMORY MENU



Delete Kit

Deletes a Kit from Memory. The **Delete Catalog Window** will appear allowing the required Kit to be chosen from all Kits currently in Memory.

Clear Memory

Clears all Kits, Drums and Samples from Memory.

Info

Selects the **Memory Information Window** showing which Kits, Drums and Samples are currently loaded and how much Memory space is left.

DISK MENU

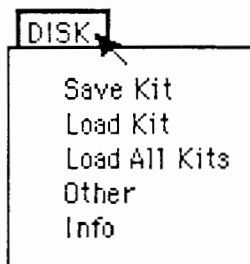

Save Kit

Saves the active Kit to Disk.

Note : The Disk must be Unprotected.

Load Kit

Loads a Kit from Disk into Memory. The **Load Catalog Window** will appear allowing the required Kit to be chosen from all the Kits currently on the Disk. Once loaded this Kit will be active.

Load All Kits

Loads all of the Kits in The Disk into Memory. A **Loading Kit... Please Wait** message will be displayed as each Kit is loaded.

Other

Provides a **Disk Operations Window**. This allows other Disk operations to be performed such as Loading any or all Kits, Drums, Samples or other data from Disk. Copy and Format options are also available.

Info

Selects the **Disk Information Window** showing the Kits, Drums and Samples currently on the Disk. The Disk Name, Serial No. and Type are also displayed along with the amount of free space remaining.

SPECIAL MENU



Easy Sampling

Transfers directly to the **Sampler Screen**, allowing New Samples to be made. Samples will not be assigned to a Dynamic or Position on any Pad but can be triggered using the right-hand Select Button. New Samples can be saved to Disk or assigned using the **Sample Assign Screen**.

KIT EDIT MENU



Kit Mixer

Transfers from Kit Select to the **Kit Mixer Screen**. This allows the overall Length and Tuning of individual Drums to be adjusted along with their Volume and Pan positions in the Stereo Mix Output.

Kit Configuration

Transfers from Kit Select to the **Kit Configuration Screen**. This allows the Kit configuration to be Defined. Each of the 16 Pads can be assigned a Pad Type, a Drum and Voice Outputs. MIDI Notes, Channels and Program Changes can also be selected.

Welcome

Returns to the SDX Welcome Screen.

Section 5.2

Reference : Kit Mixer Screen

CONTENTS

Screen Parameters	5 - 5
Kit Name	5 - 5
Other 8	5 - 5
Length Pot	5 - 5
Tune Pot	5 - 5
Pan Pot	5 - 6
Vol Slider	5 - 6
Mute Switch	5 - 6
Solo Switch	5 - 6
Kit Mixer Menu	5 - 6
Info on SDX	5 - 6
Info on Kits	5 - 6
Info on Kit Mixer	5 - 6
Control Panel	5 - 6
Memory Menu	5 - 6
Save Kit	5 - 6
Save Kit As	5 - 6
Load Kit	5 - 7
Delete Kit	5 - 7
Info	5 - 7
Disk Menu	5 - 7
Save Kit	5 - 7
Save Kit As	5 - 7
Load Kit	5 - 7
Delete Kit	5 - 7
Other	5 - 7
Info	5 - 7
Special Menu	5 - 8
Initialise Mixer	5 - 8
Set All Mutes/Solos Off	5 - 8
Pots & Slider Ranges	5 - 8
Next Menu	5 - 8
Kit Mixer	5 - 8
Kit Configuration	5 - 8
Quit	5 - 8

Creative Use of SDX

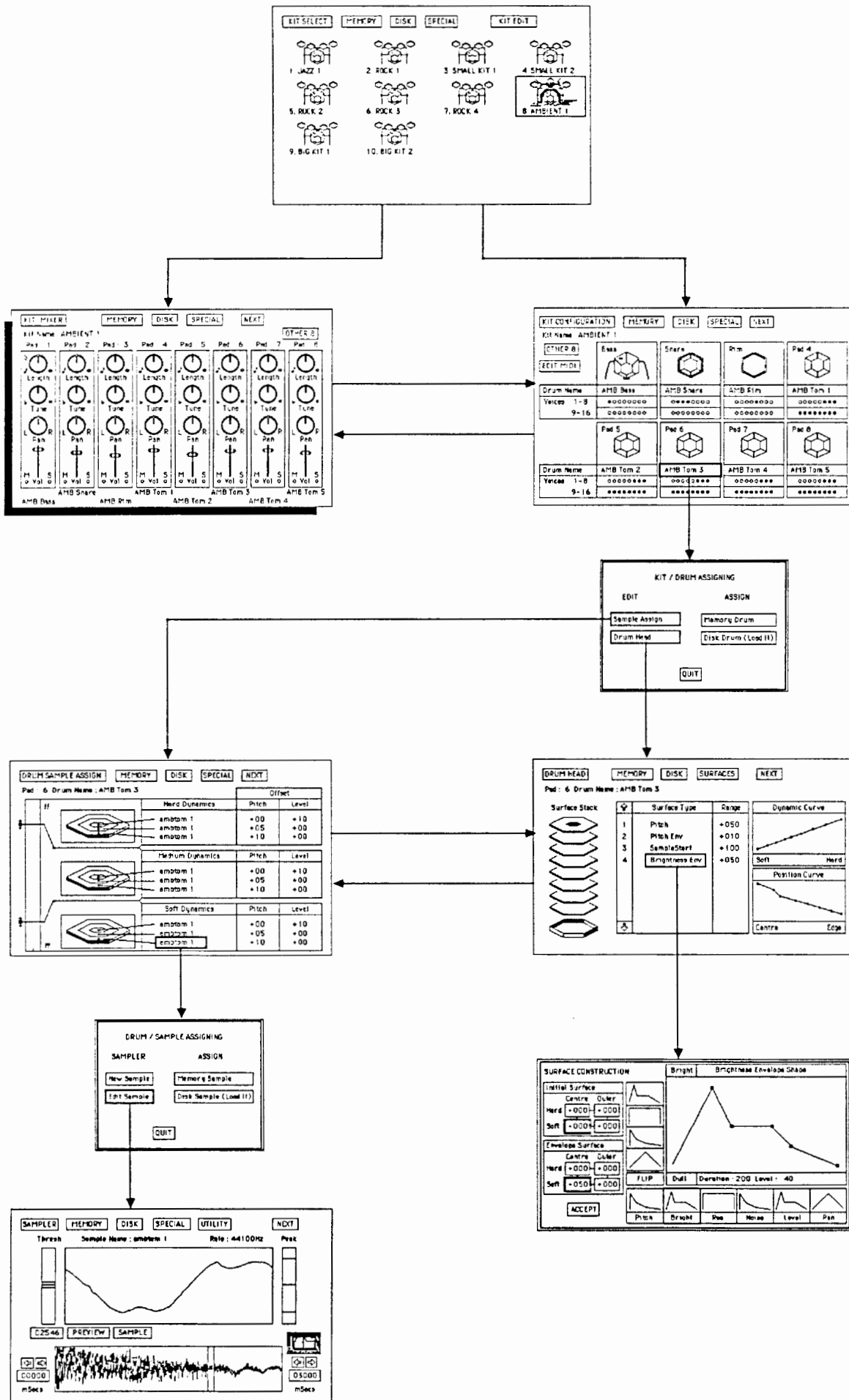

The Kit Mixer Screen allows graphic control of the 16 Drum outputs, displayed as Pads 1-8 and 9-16. Selecting and adjusting Pots or Sliders on the Screen with the Tracker Ball allows the Pitch and Length of each Drum to be adjusted, along with its Pan position and Volume in the Stereo Mix.

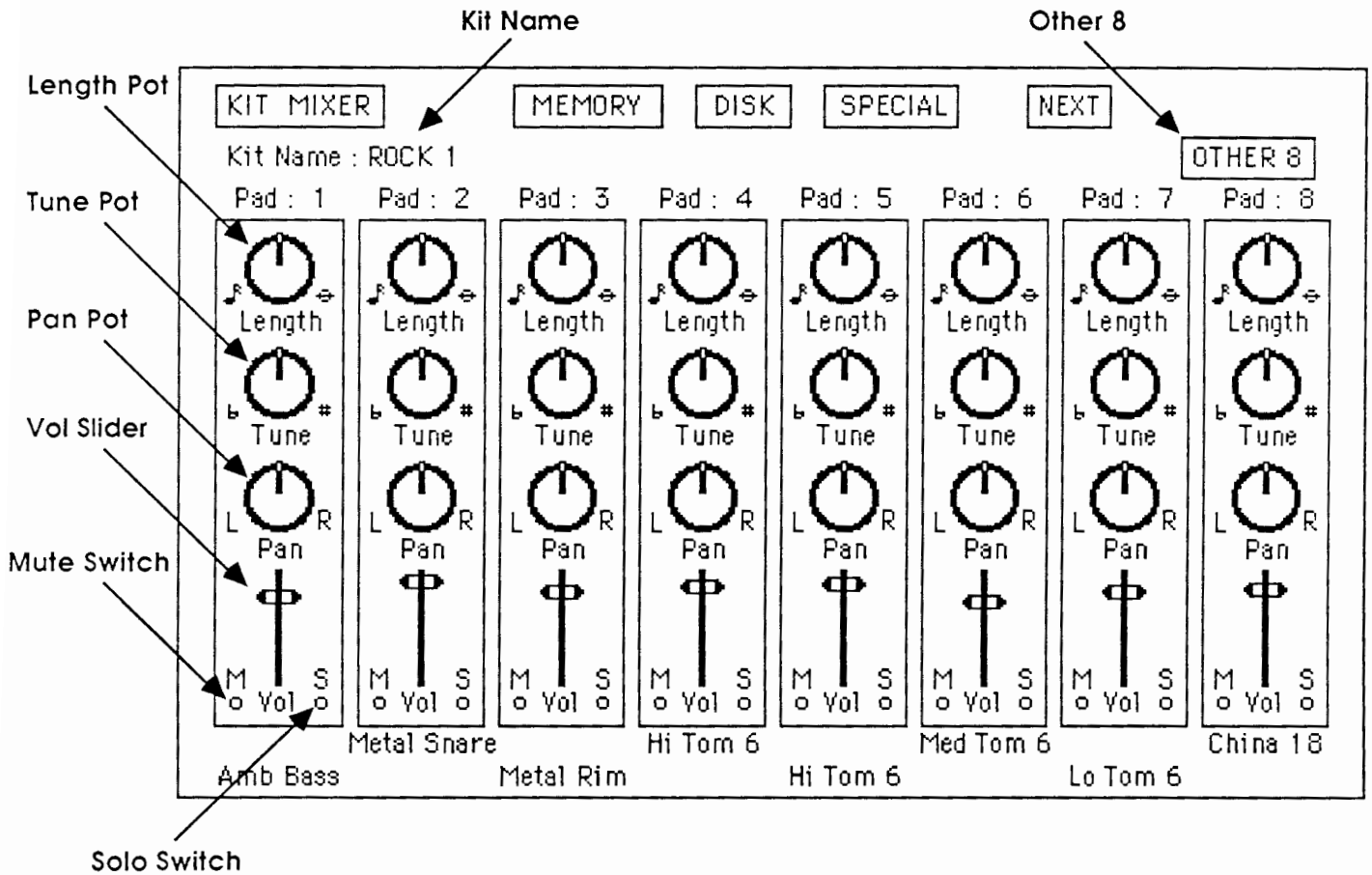

SCREEN PARAMETERS

Kit Name

Displays the name of the Active Kit.

Other 8

Click to select Pads 1-8 or 9-16.

Clicking the right-hand Select Button will perform the same function.

Length Pot

Adjusts the Length of the Drum Envelopes and Drum Samples. To increase their Length, select the Pot on the required Drum and roll the Tracker Ball right. To decrease, roll the Tracker Ball left. Double-Click to reset to maximum.

Tune Pot

Adjusts the Tuning of the Drum Sample plus or minus 12 semi-tones. To increase the Tuning, select the Pot on the required Drum and roll the Tracker Ball right. To decrease, roll the Tracker Ball left. Double Click to reset to 0.

Pan Pot

Adjusts the Pan Position of the Drum sound in the Stereo Out Mix from Left to Right. To move to the right, select the Pot on the required Drum and roll the Tracker Ball right. To move to the left, roll the Tracker Ball left. Double Click to reset to the centre.

Vol Slider

Adjusts the Volume of Drum Sound in the Stereo Out Mix. To increase the level, select the Slider on the required Drum and roll the Tracker Ball upwards. To decrease, roll the Tracker Ball downwards. Double Click to reset to maximum.

Mute Switch

Silences the Drum Sound. This would normally be used with a sequencer to drop Drums out of the Stereo Mix. Click on a switch to mute that Drum, indicated by a filled circle. Click again to switch off the Muting, indicated by an empty circle.

Solo Switch

Mutes all of the other Drums, leaving only the soloed drum in the Mix. Click on the switch to solo a Drum, indicated by a filled circle. Click again to switch off the Solo. Selecting another Solo will clear the old and Solo the new.

KIT DRUM MIXER MENU



Info on SDX

Provides information about the SDX Console.

Info on Kits

Provides information about Kits.

Info on Kit Mixer

Provides information about the Kit Mixer.

Control Panel

Selects the **Control Panel Window** allowing access to the 16 Pad Dynamic Meters, AutoTrigger, Key Pad modes and MIDIWatch facility.

MEMORY MENU

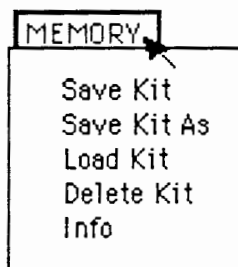

Save Kit

Saves to Memory any changes made to the current Kit.

Save Kit As

Save the current Kit to Memory with another name. The **Name Keyboard Window** appears allowing the new Kit to be named. If the name already exists the **Name Exists Window** appears allowing the Kit to be named again or the previous one to be overwritten. Once saved this Kit will be Active.

Load Kit

Loads a new Kit from Memory. The **Load Catalog Window** will appear allowing the required Kit to be chosen from those currently in Memory.

Delete Kit

Deletes a Kit from Memory. The **Delete Catalog Window** will appear allowing the required Kit to be chosen from all those currently in Memory.

Info

Selects the **Memory Information Window** showing which Kits, Drums and Samples are currently loaded and how much Memory space is left.

DISK MENU

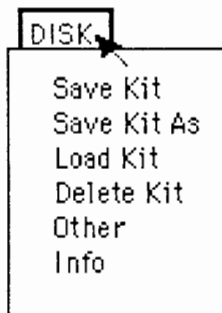

Save Kit

Saves to Disk any changes made to the current Kit.
Note : The Disk must be Unprotected.

Save Kit As

Save the current Kit to Disk with another name. The **Name Keyboard Window** appears allowing the new Kit to be named. If the name already exists the **Name Exists Window** appears allowing the Kit to be named again or the previous one to be overwritten. Once saved this Kit will be Active.
Note : The Disk must be Unprotected.

Load Kit

Loads a Kit from Disk into Memory. The **Load Catalog Window** will appear allowing the required Kit to be chosen from all the Kits currently on the Disk. Once loaded this Kit will be Active.

Delete Kit

Deletes a Kit from Disk. The **Delete Catalog Window** will appear allowing the required Kit to be chosen from all Kits currently on the Disk.
Note : The Disk in the Drive must be Unprotected.

Other

Provides a **Disk Operations Window**. This allows other Disk operations to be performed such as Loading any or all Kits, Drums, Samples or other data from Disk. Copy and Format options are also available.

Info

Selects the **Disk Information Window** showing the Kits, Drums and Samples currently on the Disk. The Disk Name, Serial No. and Type are also displayed along with the amount of free space remaining.

SPECIAL MENU

SPECIAL

Initialise Mixer
Set All Mutes/Solos Off
Pots & Slider Ranges

Initialise Mixer

Initialises all controls on the 16 Drums of the Kit Mixer. Lengths are set to maximum. Tuning offsets are set to zero. Pans are set to the centre and Volumes set to maximum.

Set All Mutes/Solos Off

Clears any Mutes or Solos on any of the 16 Drums.

Pots and Slider Ranges

Allows the sensitivity of the Pots and Sliders to be adjusted for the Kit Mixer Screen.

NEXT MENU

NEXT

Kit Mixer
Kit Configuration
Quit

Kit Mixer

Remains on Kit Mixer Screen.

Kit Configuration

Transfers from Kit Mixer to the **Kit Configuration Screen**. This allows the Kit configuration to be Defined. Each of the 16 Pads can be assigned a Pad Type, a Drum and Voice Outputs. MIDI Notes, Channels and Program Changes can also be selected.

Quit

Returns to the **Kit Select Screen**. If any changes have been made to the Kit a **Save Changes Window** will appear. This allows any changes to be saved, lost or the Quit cancelled.

Section 5.3

Reference : Kit Configuration Screen

CONTENTS

Screen Parameters	5 - 9	Special MIDI Menu	5 - 13
Kit Name	5 - 9	Pad Type as Default	5 - 13
Other 8	5 - 9	Pad Type All Pitched	5 - 14
Pad Type	5 - 9	MIDI Notes as Default	5 - 14
Drum Assign	5 - 9	MIDI Channels as Default	5 - 14
Voice Assign	5 - 10	MIDI Note Decimal	5 - 14
		MIDI Note Chromatic	5 - 14
Edit MIDI	5 - 10	Next Menu	5 - 14
Edit MIDI	5 - 10	Kit Mixer	5 - 14
MIDI Note	5 - 10	Kit Configuration	5 - 14
MIDI Channel	5 - 10	Quit	5 - 14
MIDI Program	5 - 11		
Kit Configuration Menu	5 - 11		
Info on SDX	5 - 11		
Info on Kits	5 - 11		
Info on Kit Configuration	5 - 11		
Info on Voice Assignment	5 - 11		
Control Panel	5 - 11		
Memory Menu	5 - 11		
Save Kit	5 - 11		
Save Kit As	5 - 11		
New Kit	5 - 11		
Load Kit	5 - 11		
Delete Kit	5 - 11		
Info	5 - 11		
Disk Menu	5 - 12		
Save Kit	5 - 12		
Save Kit As	5 - 12		
Load Kit	5 - 12		
Delete Kit	5 - 12		
Other	5 - 12		
Info	5 - 12		
Special Voice Menu	5 - 12		
Pad Type as Default	5 - 12		
Pad Type All Pitched	5 - 13		
Voice Assign as Default	5 - 13		
Voice Assign 1 to 1	5 - 13		
Voice Assign All to All	5 - 13		

Creative Use of SDX

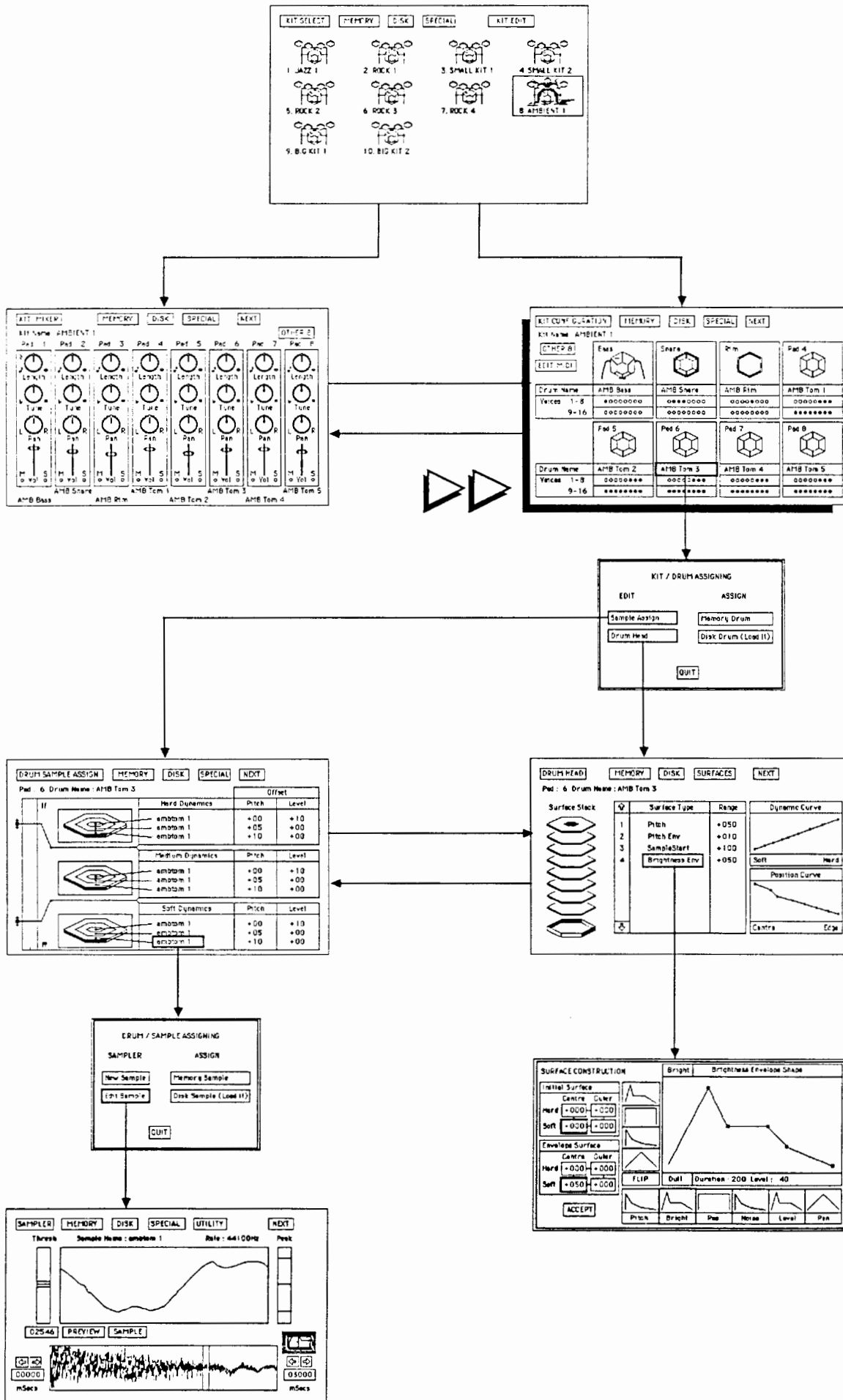

Kit Configuration

Using the Kit Configuration Screen it is possible to see exactly what combination of Drums, Symbals and Hi-Hat make up a Kit. Drums may be replaced by others from Disk, or from other Kits in Memory. Each Drum can be allocated a Voice or Voices and have MIDI Notes and Channel assigned.

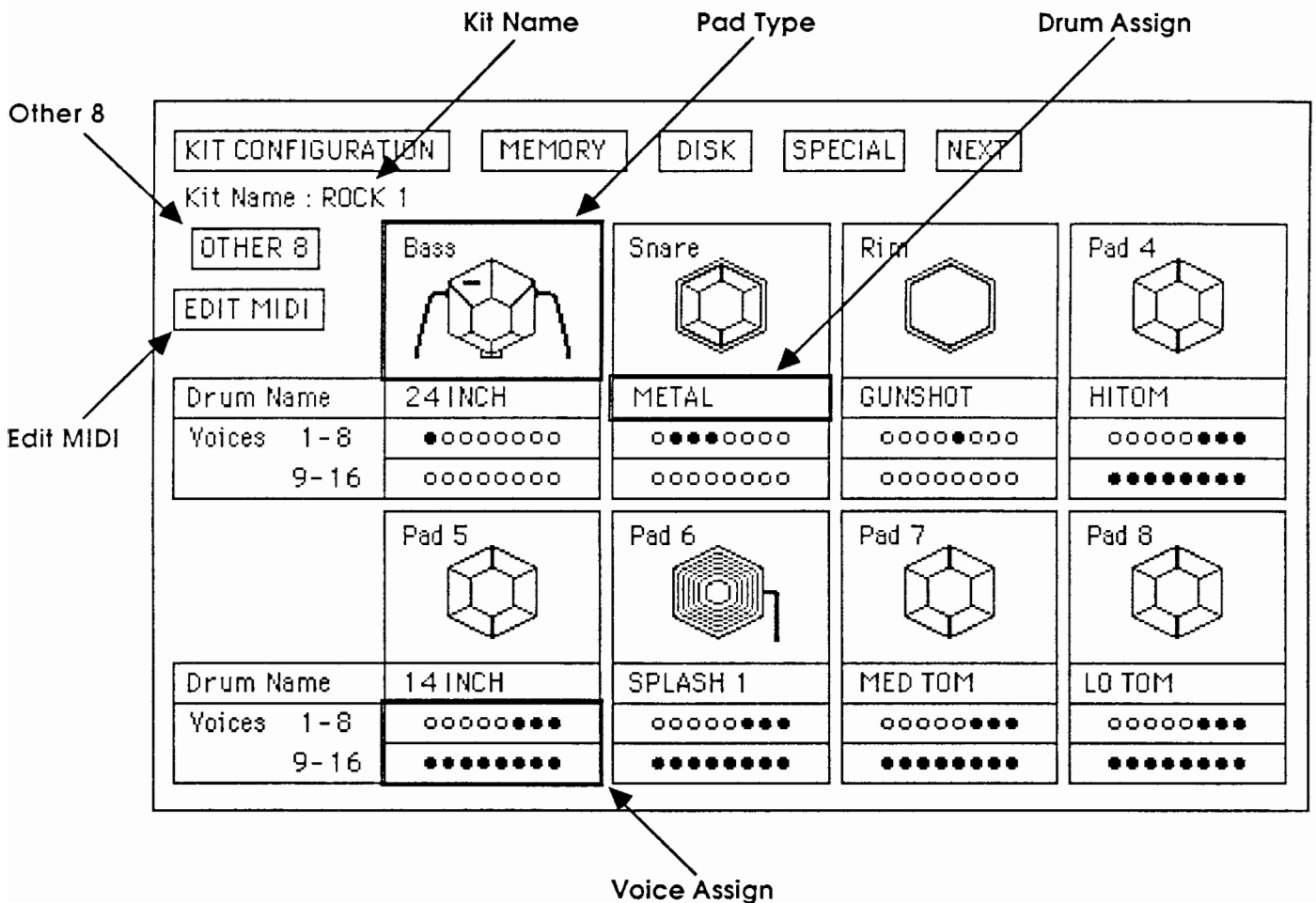

SCREEN PARAMETERS

Kit Name

Displays the name of the Active Kit.

Other 8

Click to select Pads 1-8 or 9-16.

Clicking the right-hand Select Button will perform the same function.

Pad Type

Clicking on any Pad icon produces the **Pad Select Window**. This allows a new Pad type to be selected, replacing the current one.

Drum Assign

Clicking on any Drum Name produces the **Drum Assigning Window**. This allows other Drums to be loaded from Memory or Disk. The **Drum Head Screen** and **Sample Assign Screens** are also accessed from this Window.

Creative Use of SDX

Voice Assign

Voices 1-8 and 9-16 are represented as rows of small circles. These are switches which when turned on, show the Voice is assigned. Clicking on any switch will turn it on. Click again to turn off.

EDIT MIDI

Edit MIDI

Clicking on this box selects the MIDI display, showing MIDI notes, Channels and Program Change. The Special Menu will now display a choice of MIDI Options. Clicking on the **Edit Voice** box returns to the Voice display.

Kit Name: ROCK 1

Pad	Drum Name	MIDI Note	Channel
1	Bass	40	1
2	Snare	41	2
3	Rim	42	3
4	Pad 4	43	4
5	Pad 5	44	5
6	Pad 6	45	6
7	Pad 7	46	7
8	Pad 8	47	8

MIDI Note

Pointing to any Pad's MIDI Note will produce a Numeric Box, which allows the MIDI Note to be adjusted from 0 to 127 using up and down movement of the Tracker Ball.

MIDI Channel

Pointing to any Pad's MIDI Channel will produce a Numeric Box, which allows the MIDI Channel to be adjusted from 1 to 16 using up and down movement of the Tracker Ball.

MIDI Program

Pointing to the MIDI Program number will produce a Numeric Box, which allows the Program number to be adjusted, from 1 to 128, using up and down movement of the Tracker Ball.

KIT CONFIGURATION MENU

KIT CONFIGURATION

Info on SDX
Info on Kits
Info on Kit Configuration
Info on Voice Assignment
Control Panel

Info on SDX

Provides information about the SDX Console.

Info on Kits

Provides information about Kits.

Info on Kit Configuration

Provides information about Configuring Kits.

Information on Voice Assignment

Provides information about assigning Voices.

Control Panel

Selects the **Control Panel Window** allowing access to the 16 Pad Dynamic Meters, AutoTrigger, Key Pad modes and MIDIWatch facility.

MEMORY MENU

MEMORY

Save Kit
Save Kit As
New Kit
Load Kit
Delete Kit
Info

Save Kit

Saves to Memory any changes made to the current Kit.

Save Kit As

Save the current Kit to Memory with another name. The **Name Keyboard Window** appears allowing the new Kit to be named. If the name already exists the **Name Exists Window** appears allowing the Kit to be named again or the previous one to be overwritten. Once saved this Kit will be Active.

New Kit

Not Implemented Yet.

Load Kit

Loads a new Kit from Memory. The **Load Catalog Window** will appear allowing the required Kit to be chosen from those currently in Memory.

Delete Kit

Deletes a Kit from Memory. The **Delete Catalog Window** will appear allowing the required Kit to be chosen from all those currently in Memory.

Info

Selects the **Memory Information Window** showing which Kits, Drums and Samples are currently loaded and how much Memory space is left.

DISK MENU

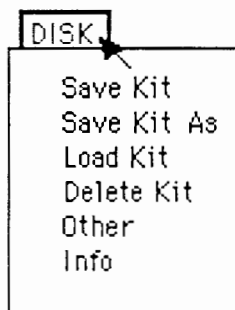

Save Kit

Saves to Disk any changes made to the current Kit.
 Note : The Disk must be Unprotected.

Save Kit As

Save the current Kit to Disk with another name. The **Name Keyboard Window** appears allowing the new Kit to be named. If the name already exists the **Name Exists Window** appears allowing the Kit to be named again or the previous one to be overwritten. Once saved this Kit will be Active.
 Note : The Disk must be Unprotected.

Load Kit

Loads a Kit from Disk into Memory. The **Load Catalog Window** will appear allowing the required Kit to be chosen from all the Kits currently on the Disk. Once loaded this Kit will be Active.

Delete Kit

Deletes a Kit from Disk. The **Delete Catalog Window** will appear allowing the required Kit to be chosen from all Kits currently on the Disk.
 Note : The Disk in the Drive must be Unprotected.

Other

Provides a **Disk Operations Window**. This allows other Disk operations to be performed such as Loading any or all Kits, Drums, Samples or other data from Disk. Copy and Format options are also available.

Info

Selects the **Disk Information Window** showing the Kits, Drums and Samples currently on the Disk. The Disk Name, Serial No. and Type are also displayed along with the amount of free space remaining.

SPECIAL VOICE MENU

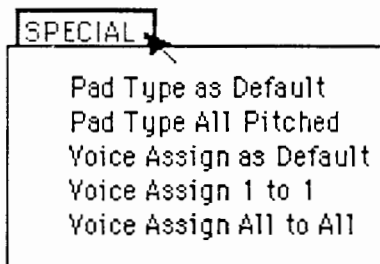

Pad Type as Default

Assigns the 16 Pads to their default setting :

Pad 1	Bass	Pad 9	Tom
Pad 2	Snare	Pad 10	Tom
Pad 3	Rim	Pad 11	Tom
Pad 4	Tom	Pad 12	Tom
Pad 5	Tom	Pad 13	Symbal
Pad 6	Tom	Pad 14	Symbal
Pad 7	Tom	Pad 15	Symbal
Pad 8	Tom	Pad 16	Hi-Hat

Pad Type All Pitched

Assigns the 16 Pads to be Pitched.

Voice Assign as Default

Assigns the 16 Voices to their default setting :

Pad 1	Voice 1	Pad 9	Voices 6-16
Pad 2	Voices 2,3,4	Pad 10	Voices 6-16
Pad 3	Voice 5	Pad 11	Voices 6-16
Pad 4	Voices 6-16 shared	Pad 12	Voices 6-16
Pad 5	Voices 6-16	Pad 13	Voices 6-16
Pad 6	Voices 6-16	Pad 14	Voices 6-16
Pad 7	Voices 6-16	Pad 15	Voices 6-16
Pad 8	Voices 6-16	Pad 16	Voices 6-16

Voice Assign 1 to 1

Assigns each Voices directly to it's corresponding Pad.

Pad 1	Voice 1	Pad 9	Voice 9
Pad 2	Voice 2	Pad 10	Voice 10
Pad 3	Voice 3	Pad 11	Voice 11
Pad 4	Voice 4	Pad 12	Voice 12
Pad 5	Voice 5	Pad 13	Voice 13
Pad 6	Voice 6	Pad 14	Voice 14
Pad 7	Voice 7	Pad 15	Voice 15
Pad 8	Voice 8	Pad 16	Voice 16

Voice Assign All to All

Assigns all 16 Voices to each Pad. Pads therefore share Voices and grab a new Voice on each hit.

Pad 1	Voices 1-16 shared	Pad 9	Voices 1-16
Pad 2	Voices 1-16	Pad 10	Voices 1-16
Pad 3	Voices 1-16	Pad 11	Voices 1-16
Pad 4	Voices 1-16	Pad 12	Voices 1-16
Pad 5	Voices 1-16	Pad 13	Voices 1-16
Pad 6	Voices 1-16	Pad 14	Voices 1-16
Pad 7	Voices 1-16	Pad 15	Voices 1-16
Pad 8	Voices 1-16	Pad 16	Voices 1-16

SPECIAL MIDI MENU

SPECIAL

Pad Type as Default
 Pad Type All Pitched
 MIDI Notes as Default
 MIDI Channels as Default
 MIDI Note Decimal
 MIDI Note Chromatic

Pad Type as Default

Assigns the 16 Pads to their default setting :

Pad 1	Bass	Pad 9	Tom
Pad 2	Snare	Pad 10	Tom
Pad 3	Rim	Pad 11	Tom
Pad 4	Tom	Pad 12	Tom
Pad 5	Tom	Pad 13	Symbal
Pad 6	Tom	Pad 14	Symbal
Pad 7	Tom	Pad 15	Symbal
Pad 8	Tom	Pad 16	Hi-Hat

Pad Type All Pitched

Assigns the 16 Pads to be Pitched.

MIDI Notes as Default

Assigns the MIDI Note of each Pad to the default setting :

Pad 1	60 / C5	Pad 9	68 / G#5
Pad 2	61 / C#5	Pad 10	69 / A5
Pad 3	62 / D5	Pad 11	70 / A#5
Pad 4	63 / D#5	Pad 12	71 / B5
Pad 5	64 / E5	Pad 13	72 / C6
Pad 6	65 / F5	Pad 14	73 / C#6
Pad 7	66 / F#5	Pad 15	74 / D6
Pad 8	67 / G5	Pad 16	75 / D#6

MIDI Channels as Default

Assigns the MIDI Note of each Pad to the default setting :

Pad 1	Channel 1	Pad 9	Channel 1
Pad 2	Channel 1	Pad 10	Channel 1
Pad 3	Channel 1	Pad 11	Channel 1
Pad 4	Channel 1	Pad 12	Channel 1
Pad 5	Channel 1	Pad 13	Channel 1
Pad 6	Channel 1	Pad 14	Channel 1
Pad 7	Channel 1	Pad 15	Channel 1
Pad 8	Channel 1	Pad 16	Channel 1

MIDI Note Decimal

Display the MIDI Note as a Decimal Value from 0 to 127.
Where Middle C = 60

MIDI Note Chromatic

Display the MIDI Note as a Chromatic Value from C0 to G:
Where ':' = Octave 10.

NEXT MENU

NEXT

Kit Mixer
Kit Configuration
Quit

Kit Mixer

Transfers from Kit Configuration to the **Kit Mixer Screen**. This allows the overall Length and Tuning of individual Drums to be adjusted along with their Volume and Pan positions in the Stereo Mix Output.

Kit Configuration

Remains on the **Kit Configuration Screen**.

Quit

Returns to the **Kit Select Screen**. If any changes have been made to the Kit a **Save Changes Window** will appear. This allows any changes to be saved, lost or the Quit cancelled.

Section 5.4

Reference : Drum Sample Assign Screen

CONTENTS

Screen Parameters	5 - 15	Special Menu	5 - 19
Drum Name	5 - 15	Set All as Soft/Outer	5 - 19
Sample Assign	5 - 15		
Pitch Offset	5 - 16	Next Menu	5 - 20
Level Offset	5 - 16	Drum Sample Assign	5 - 20
Dynamic Level Meter	5 - 16	Drum Head	5 - 20
Medium Threshold Handle	5 - 16	Quit	5 - 20
HardThreshold Handle	5 - 16		
Current Dynamic/Position	5 - 16		
Bass, Rim and Pitched Drums	5 - 16		
Hi-Hat Sample Assign	5 - 17		
Sample Assign	5 - 17		
Pitch Offset	5 - 17		
Level Offset	5 - 17		
Pedal Position Indicator	5 - 17		
Open Threshold Handle	5 - 18		
Sizzle Threshold Handle	5 - 18		
Pedal Trigger Threshold	5 - 18		
Drum Sample Assign Menu	5 - 18		
Info on SDX	5 - 18		
Info on Drums	5 - 18		
Info on Sample Assigning	5 - 18		
Control Panel	5 - 18		
Memory Menu	5 - 18		
Save Drum	5 - 18		
Save Drum As	5 - 18		
New Drum	5 - 18		
Load Drum	5 - 18		
Delete Drum	5 - 18		
Info	5 - 19		
Disk Menu	5 - 19		
Save Drum	5 - 19		
Save Drum As	5 - 19		
Load Drum	5 - 19		
Delete Drum	5 - 19		
Other	5 - 19		
Info	5 - 19		

Creative Use of SDX

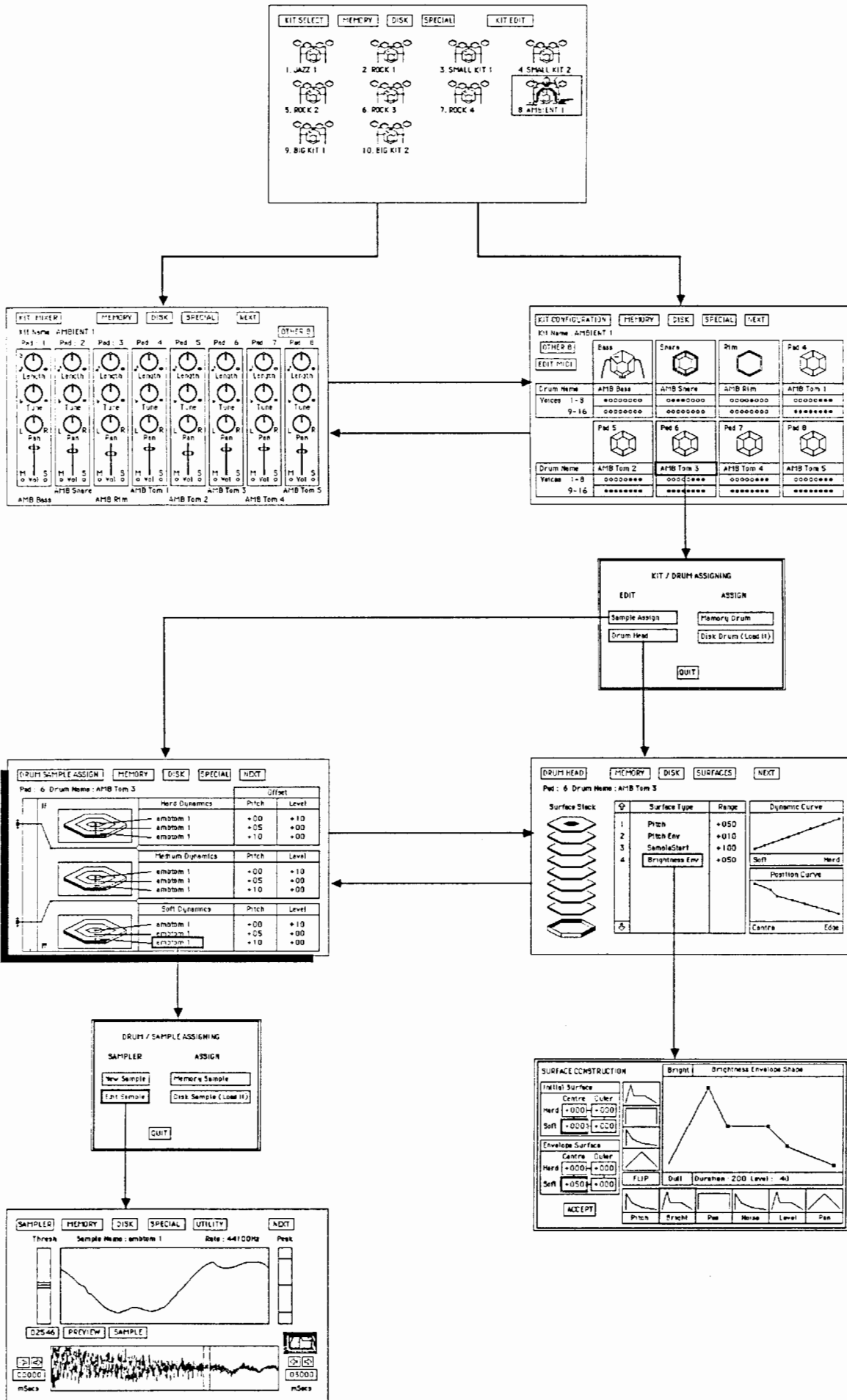

Drum Sample Assign

Each Snare, Tom, or Symbal pad can be assigned up to 9 different Samples. These Samples are selected by the position and weight of each stroke on the pad. The Sample Assign Screen allows Samples can be assigned by name to the individual dynamic and position points on the pad. Each Sample can also be given a Pitch and Level offset.

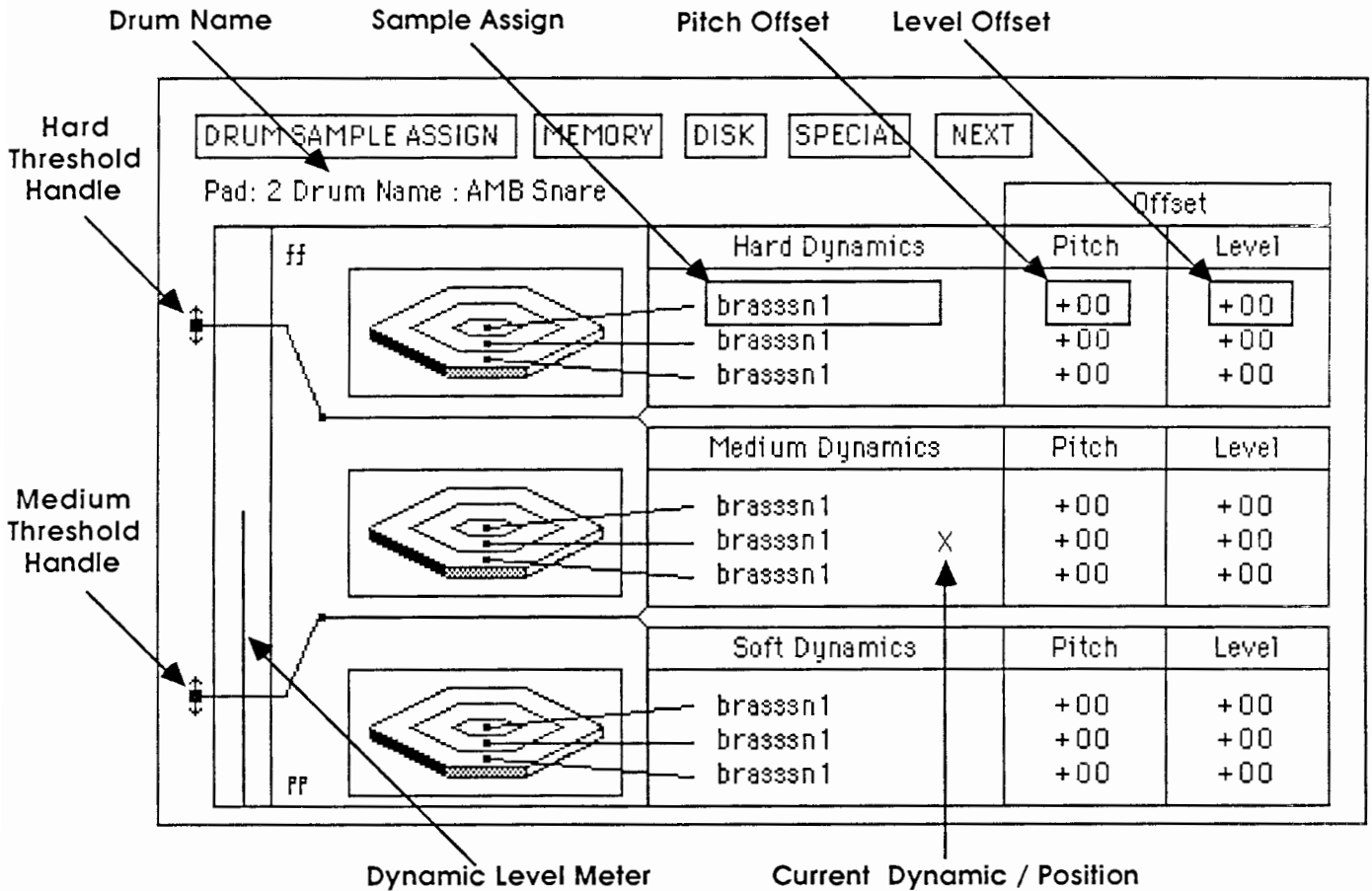

SCREEN PARAMETERS

Drum Name

Displays the name of the current Drum.

Sample Assign

Clicking on any Sample Name produces the **Sample Assigning Window**. This allows other Samples to be Loaded from Memory or Disk. The **Sampler** Screen is also accessed from this Window.

- Clicking on the Name of the **Soft Dynamics, Outside Sample**, when the Samples above are the same, allows the same Sample to be loaded into all 3 Positions in all 3 Dynamic Levels.
- Clicking on the Name of the **Medium Dynamics, Outside Sample**, when the Samples above are the same, allows the same Sample to be loaded into all 3 Positions in Medium and Hard Dynamic Levels.
- Clicking on the Name of the **Hard Dynamics, Outside Sample**, when the Samples above are the same, allows the same Sample to be loaded into all 3 Positions in Hard Dynamic Levels.

Pitch Offset

Pointing to any Pitch Offset will produce a Numeric Box which allows the Pitch of the corresponding Sample to be Fine-tuned by plus or minus 12 Semitones.

Level Offset

Pointing to any Level Offset will produce a Numeric Box which allows the Level of the corresponding Sample to be adjusted.

Dynamic Level Meter

When the Pad for this Drum is struck, a line within the Dynamic Meter indicates how hard it was hit.

Hard Threshold Handle

Grabbing this Handle with the Pointer allows the crossover point between the Medium and Hard Dynamic Samples to be adjusted.

Medium Threshold Handle

Grabbing this Handle with the Pointer allows the crossover point between the Soft and Medium Dynamic Samples to be adjusted.

Current Dynamic/Position

When the pad for this Drum is struck, a cross appears next to the Sample Name that was selected, indicating the strike Dynamic and Position.

BASS, RIM AND PITCHED DRUMS

The Sample Assign Screen for Bass, Rim and Pitched Drums is slightly different from the Screen shown. None of these Drums has Positional information and therefore only 3 different Samples can be assigned, one to each Dynamic level. The Screen Parameters, however, are the same as those shown.

HI-HAT SAMPLE ASSIGN

The chosen Hi-Hat Pad can also have Samples Assigned to it. However these are selected by the Pedal Position and strike Position. In addition, a seventh Sample can be assigned to the Pedal Trigger.

Sample Assign Pitch Offset Level Offset

The screenshot shows the 'DRUM SAMPLE ASSIGN' window for Pad 16, Hi Hat. On the left, a vertical 'Pedal Range' indicator shows the pedal's position between 'Open' and 'Closed' states, with 'Open Threshold Handle' and 'Sizzle Threshold Handle' markers. The main table lists samples for each state with their respective Pitch and Level offsets.

		Offset	
		Pitch	Level
Open	hihat open	+00	+00
	hihat open	+00	+00
Sizzle	hihat sizz	+00	+00
	hihat sizz	+00	+00
Closed	hihat clos	+00	+00
	hihat clos	+00	+00
Pedal Trigger	hihat ped	+00	+00

Pedal Position Indicator

Open Threshold Handle

Sizzle Threshold Handle

Pedal Trigger Threshold

Sample Assign

Clicking on any Sample Name produces the **Sample Assigning Window**. This allows other Samples to be loaded from Memory or Disk. The **Sampler** Screen is also accessed from this window.

Pitch Offset

Pointing to any Pitch offset will produce a Numeric Box which allows the Pitch of the corresponding Sample to be Fine-tuned by plus or minus 12 Semitones.

Level Offset

Pointing to any Level offset will produce a Numeric Box which allows the Level of the corresponding Sample to be adjusted.

Pedal Position Indicator

When the Hi-Hat Pedal is operated an indicator will move up or down showing the position between Open and Closed.

Open Threshold Handle

Grabbing this handle with the Pointer allows the cross over point between Open and Sizzle Samples to be adjusted.

Sizzle Threshold Handle

Grabbing this handle with the Pointer allows the cross over point between Sizzle and Closed Samples to be adjusted.

Pedal Trigger Threshold

Grabbing this Arrow with the Pointer allows the Pedal Trigger point to be adjusted.

DRUM SAMPLE ASSIGN MENU

DRUM SAMPLE ASSIGN

Info on SDX
Info on Drums
Info on Sample Assigning
Control Panel

Info on SDX

Provides information about the SDX Console.

Info on Drums

Provides information about Drums.

Info on Sample Assigning

Provides information about Assigning Drum Samples.

Control Panel

Selects the **Control Panel Window** allowing access to the 16 Pad Dynamic Meters, AutoTrigger, Key Pad modes and MIDWatch facility.

MEMORY MENU

MEMORY

Save Drum
Save Drum As
New Drum
Load Drum
Delete Drum
Info

Save Drum

Saves to Memory any changes made to the current Drum.

Save Drum As

Save the current Drum to Memory with another name. The **Name Keyboard Window** appears allowing the new Drum to be named. If the name already exists the **Name Exists Window** appears allowing the Drum to be named again or the previous one to be overwritten. Once saved this Drum will be Active.

New Drum

Not Implemented Yet.

Load Drum

Loads a new Drum from Memory. The **Load Catalog Window** will appear allowing the required Drum to be chosen from those currently in Memory.

Delete Drum

Deletes a Drum from Memory. The **Delete Catalog Window** will appear allowing the required Drum to be chosen from all those currently in Memory.

Info

Selects the **Memory Information Window** showing which Kits, Drums and Samples are currently loaded and how much Memory space is left.

DISK MENU

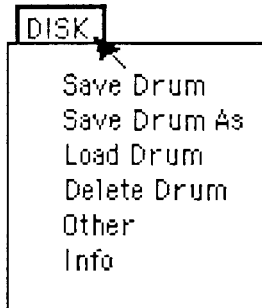

Save Drum

Saves to Disk any changes made to the current Drum.
Note : The Disk must be Unprotected.

Save Drum As

Save the current Drum to Disk with another name. The **Name Keyboard Window** appears allowing the new Drum to be named. If the name already exists the **Name Exists Window** appears allowing the Drum to be named again or the previous one to be overwritten. Once saved this Drum will be active.
Note : The Disk must be Unprotected.

Load Drum

Loads a Drum from Disk into Memory. The **Load Catalog Window** will appear allowing the required Drum to be chosen from all the Kits currently on the Disk. Once loaded this Drum will be Active.

Delete Drum

Deletes a Drum from Disk. The **Delete Catalog Window** will appear allowing the required Drum to be chosen from all Drums currently on the Disk.
Note : The Disk in the Drive must be Unprotected.

Other

Provides a **Disk Operations Window**. This allows other Disk operations to be performed such as Loading any or all Kits, Drums, Samples or other data from Disk. Copy and Format options are also available.

Info

Selects the **Disk Information Window** showing the Kits, Drums and Samples currently on the Disk. The Disk Name, Serial No. and Type are also displayed along with the amount of free space remaining.

SPECIAL MENU

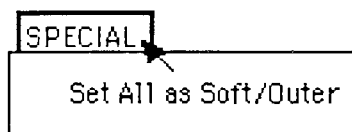

Set All as Soft/ Outer

All Samples will be replaced by the Sample loaded in the Soft/ Outer position.

NEXT MENU

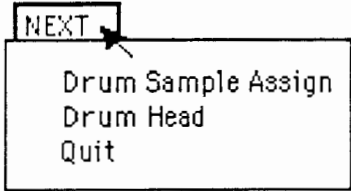

Drum Sample Assign

Remains on the **Sample Assign Screen**.

Drum Head

Transfers from Sample Assign to the **Drum Head Screen**.

Quit

Returns to the **Kit Configuration Screen**. If any changes have been made to the Drum a **Save Changes Window** will appear. This allows any changes to be saved, lost or the Quit cancelled.

Section 5.5

Reference : Drum Head Screen

CONTENTS

Screen Parameters	5 - 21
Drum Name	5 - 21
Surface Assign	5 - 21
Surface Range	5 - 21
Surface Number	5 - 21
Dynamic Curve	5 - 22
Position Curve	5 - 22
Drum Head Menu	5 - 22
Info on SDX	5 - 22
Info on Drums	5 - 22
Info on Drum Heads	5 - 22
Info on Drum Surfaces	5 - 22
Info on Drum Curves	5 - 22
Control Panel	5 - 22
Memory Menu	5 - 22
Save Drum	5 - 22
Save Drum As	5 - 22
New Drum	5 - 22
Load Drum	5 - 22
Delete Drum	5 - 23
Info	5 - 23
Disk Menu	5 - 23
Save Drum	5 - 23
Save Drum As	5 - 23
Load Drum	5 - 23
Delete Drum	5 - 23
Other	5 - 23
Info	5 - 23
Surface Menu	5 - 24
Pitch	5 - 24
Brightness	5 - 24
Resonance	5 - 24
Noise	5 - 24
Level	5 - 24
Pan	5 - 24
Length	5 - 24
SampleStart	5 - 24
Next Menu	5 - 24
Drum Sample Assign	5 - 24
Drum Head	5 - 24
Quit	5 - 24

Creative Use of SDX

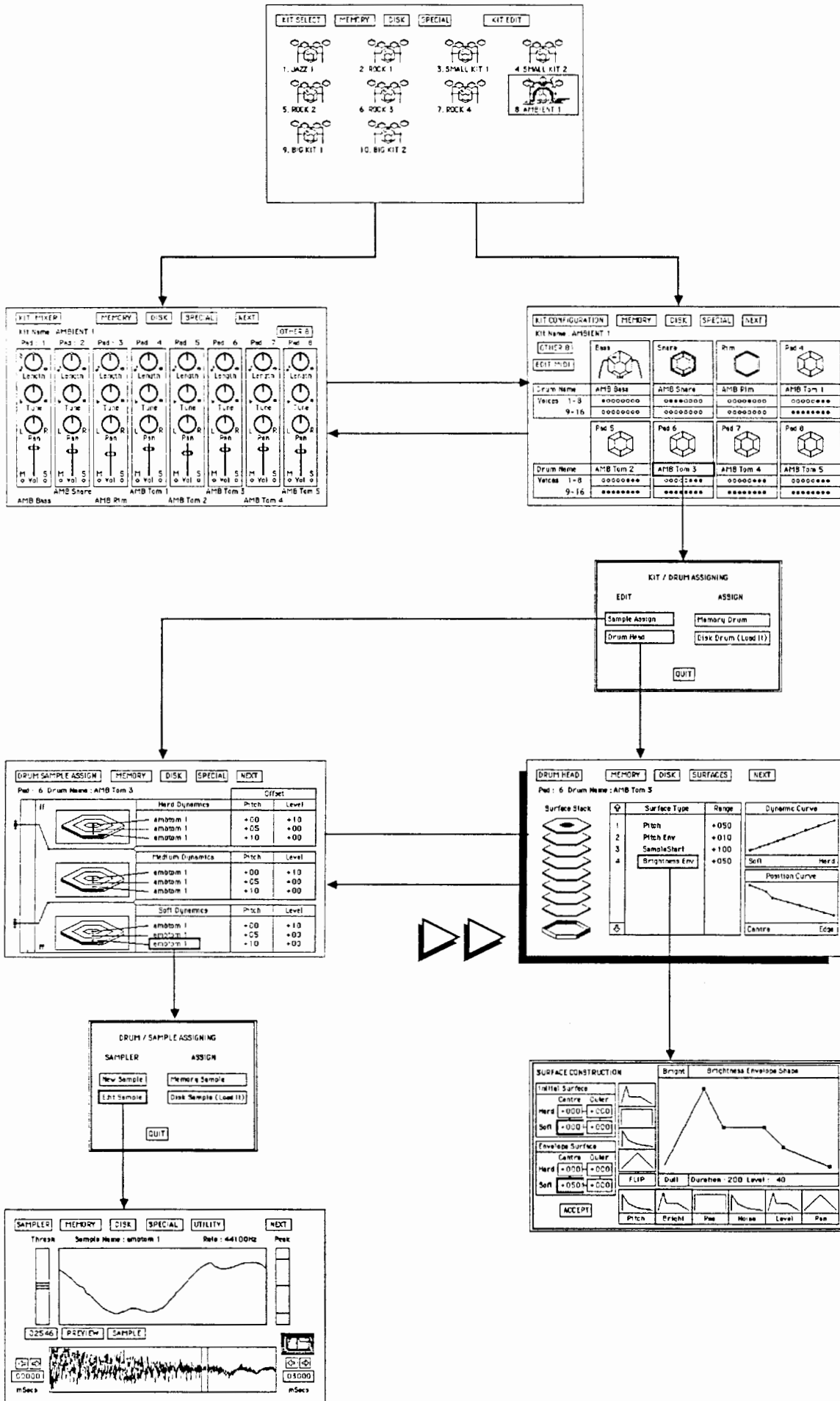

Drum Heads are constructed from a number of Surfaces. Each Surface controls a specific parameter within the Drum's Voice and determines how that parameter changes in real-time, relative to the weight and position of each stroke. Surfaces can be 'bonded together' to make a unique Head for each Drum.

Drum Name Surface Assign Surface Range Dynamic Curve

Surface Number	Surface Type	Range
1	Level Env	+499
2	Pitch	+150
3	Pitch Env	+010
4	Brightness	+020
5	Brightness Env	+099
6	Pan Env	+007
7	Noise Env	+005
8	SampleStart	+034

Surface Number Position Curve

SCREEN PARAMETERS

Drum Name

Displays the name of the current Drum.

Surface Assign

Clicking on any Surface name opens the **Surface Construction Window** for that Surface. This allows the Position and Dynamic parameters to be adjusted and the Envelope shape to be defined.

Surface Range

Selecting a Surface Range will produce a Numeric Box which allows the **Soft/Centre** value of the Surface to be adjusted by plus or minus 99. Double-Clicking resets the value to zero.

Surface Number

A Surface Number indicates how many Surfaces are bonded together to make the Drum Head. If there are more than 8 Surfaces displayed they can be viewed by clicking on the up or down arrows.

Dynamic Curve

Allows the relationship between, the strike Weight and the amount of Dynamic effect produced, to be defined by 9 points on a Curve. The Curve can be adjusted by selecting a Point and dragging it with the Tracker Ball.

Position Curve

Allows the relationship between, the strike Position and the amount of Positional effect produced, to be defined by 9 points on a Curve. The Curve can be adjusted by selecting a Point and dragging it with the Tracker Ball.

DRUM HEAD MENU

DRUM HEAD

Info on SDX
Info on Drums
Info on Drum Heads
Info on Drum Surfaces
Info on Drum Curves
Control Panel

Info on SDX

Provides information about the SDX Console.

Info on Drums

Provides information about Drums

Info on Drum Heads

Provides information about Drum Heads.

Info on Drum Surfaces

Provides information about Drum Surfaces.

Info on Drum Curves

Provides information about Drum Curves.

Control Panel

Selects the **Control Panel Window** allowing access to the 16 Pad Dynamic Meters, AutoTrigger, Key Pad modes and MIDIWatch facility.

MEMORY MENU

MEMORY

Save Drum
Save Drum As
New Drum
Load Drum
Delete Drum
Info

Save Drum

Saves to Memory any changes made to the current Drum.

Save Drum As

Save the current Drum to Memory with another name. The **Name Keyboard Window** appears allowing the new Drum to be named. If the name already exists the **Name Exists Window** appears allowing the Drum to be named again or the previous one to be overwritten. Once saved this Drum will be Active.

New Drum

Not Implemented Yet.

Load Drum

Loads a new Drum from Memory. The **Load Catalog Window** will appear allowing the required Drum to be chosen from those currently in Memory.

Delete Drum

Deletes a Drum from Memory. The **Delete Catalog Window** will appear allowing the required Drum to be chosen from all those currently in Memory.

Info

Selects the **Memory Information Window** showing which Kits, Drums and Samples are currently loaded and how much Memory space is left.

DISK MENU

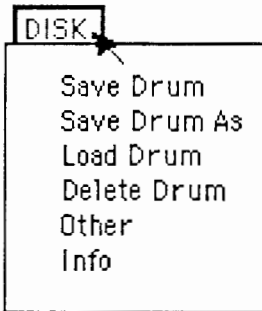

Save Drum

Saves to Disk any changes made to the current Drum.
Note : The Disk must be Unprotected.

Save Drum As

Save the current Drum to Disk with another name. The **Name Keyboard Window** appears allowing the new Drum to be named. If the name already exists the **Name Exists Window** appears allowing the Drum to be named again or the previous one to be overwritten. Once saved this Drum will be active.
Note : The Disk must be Unprotected.

Load Drum

Loads a Drum from Disk into Memory. The **Load Catalog Window** will appear allowing the required Drum to be chosen from all the Kits currently on the Disk. Once loaded this Drum will be Active.

Delete Drum

Deletes a Drum from Disk. The **Delete Catalog Window** will appear allowing the required Drum to be chosen from all Drums currently on the Disk.
Note : The Disk in the Drive must be Unprotected.

Other

Provides a **Disk Operations Window**. This allows other Disk operations to be performed such as Loading any or all Kits, Drums, Samples or other data from Disk. Copy and Format options are also available.

Info

Selects the **Disk Information Window** showing the Kits, Drums and Samples currently on the Disk. The Disk Name, Serial No. and Type are also displayed along with the amount of free space remaining.

SURFACE MENU

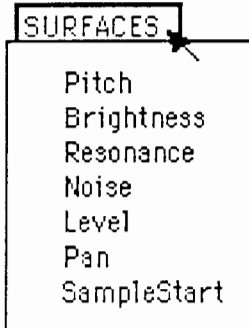

The Surface Menu allows new Surfaces to be added to the Surface list. If the parameters in the **Surface Constuction Window** are set to anything other than zero, the new Surface will be added to the list and become part of the Drum Head.

Pitch

Opens a **Surface Constuction Window** for the Pitch Surface.

Brightness

Opens a **Surface Constuction Window** for the Brightness Surface.

Resonance

Opens a **Surface Constuction Window** for the Resonance Surface.

Noise

Opens a **Surface Constuction Window** for the Noise Surface.

Level

Opens a **Surface Constuction Window** for the Level Surface.

Pan

Opens a **Surface Constuction Window** for the Pan Surface.

Length

Opens a **Surface Constuction Window** for the Length Surface.

SampleStart

Opens a **Surface Constuction Window** for the SampleStart Surface.

NEXT MENU

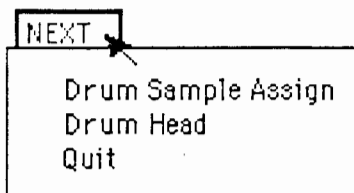

Drum Sample Assign

Transfers from Drum Head to the **Sample Assign Screen**.

Drum Head

Remains on the **Drum Head Screen**.

Quit

Returns to the **Kit Configuration Screen**. If any changes have been made to the Drum a **Save Changes Window** will appear. This allows any changes to be saved, lost or the Quit cancelled.

Section 5.6

Reference : Sampler Screen

CONTENTS

Screen Parameters	5 - 25	Special Menu	5 - 29
Sample Name	5 - 25	Loop Options	5 - 29
Rate	5 - 25	Clear Samples not in Window	5 - 29
Peak Meter	5 - 25	Reverse Samples in Window	5 - 29
Threshold Adjust	5 - 25	Maximise Sample Amplitude	5 - 29
Sample Window	5 - 26	Protection	5 - 29
View Bars	5 - 26	Utility Menu	5 - 29
Loop Pointers	5 - 26	Sine	5 - 29
Edit Pointers	5 - 26	Hi-Ramp	5 - 29
Zoom Window	5 - 26	Lo-Ramp	5 - 29
Preview	5 - 26	Next Menu	5 - 29
Sample	5 - 26	Quit	5 - 29
Start Point	5 - 26		
End Point	5 - 26		
Sample Protection	5 - 26		
Marker Select	5 - 27		
Sampler Menu	5 - 27		
Info on SDX	5 - 27		
Info on the Sampler	5 - 27		
Info on Looping	5 - 27		
Info on Truncating	5 - 27		
Control Panel	5 - 27		
Memory Menu	5 - 27		
Rename Sample	5 - 27		
Save Sample Truncated	5 - 27		
New Sample	5 - 27		
Edit Sample	5 - 27		
Delete Sample	5 - 27		
Info	5 - 27		
Disk Menu	5 - 28		
Save Sample	5 - 28		
Save Sample As	5 - 28		
Save Sample Truncated	5 - 28		
Edit Sample	5 - 28		
Delete Sample	5 - 28		
Other	5 - 28		
Info	5 - 28		

Creative Use of SDX

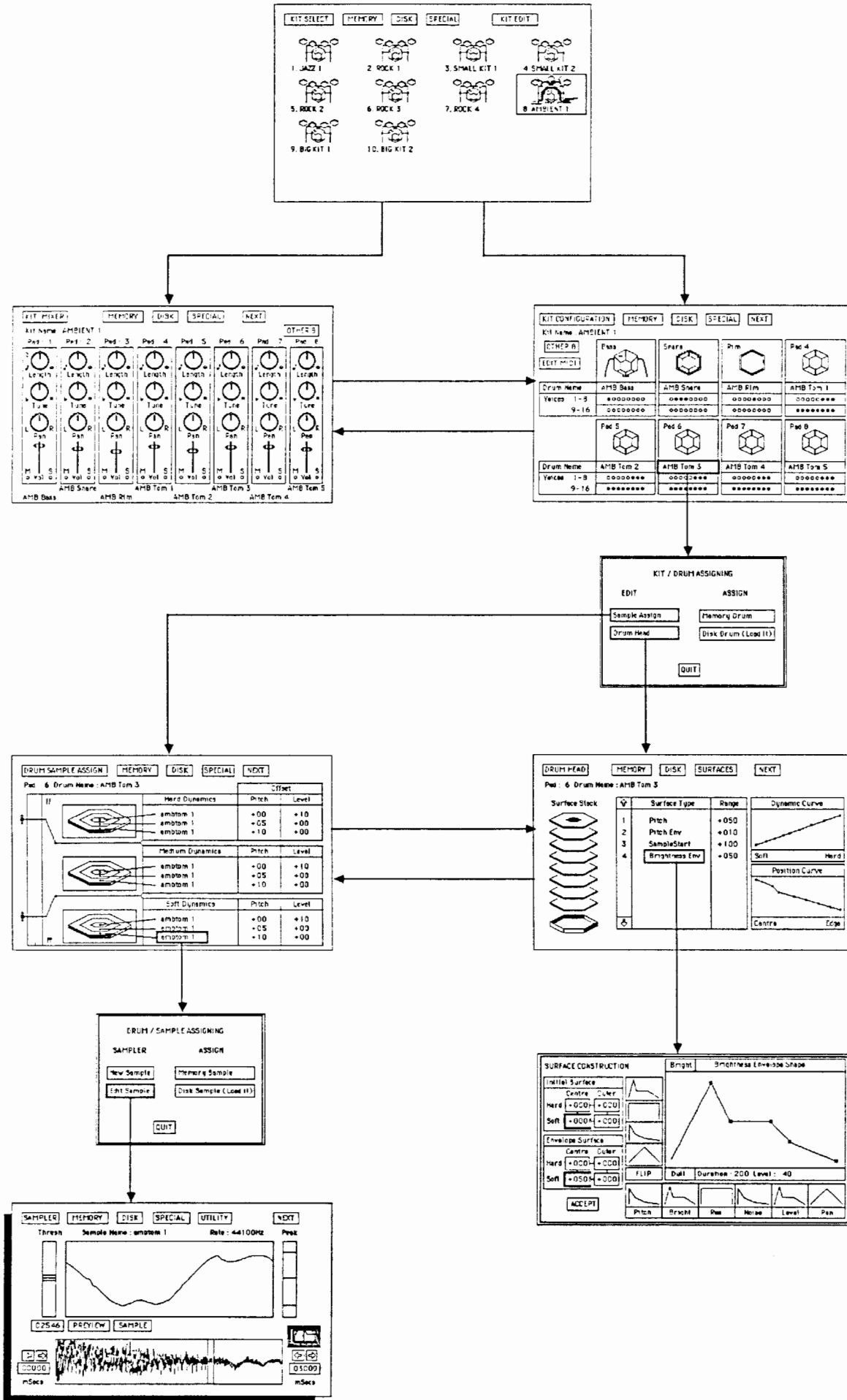

The Sampler Screen allows the Sample waveform to be displayed. New 16 bit, CD quality Samples can be made or previous Samples may be Edited. Looping points may also be positioned to allow Samples to be extended.

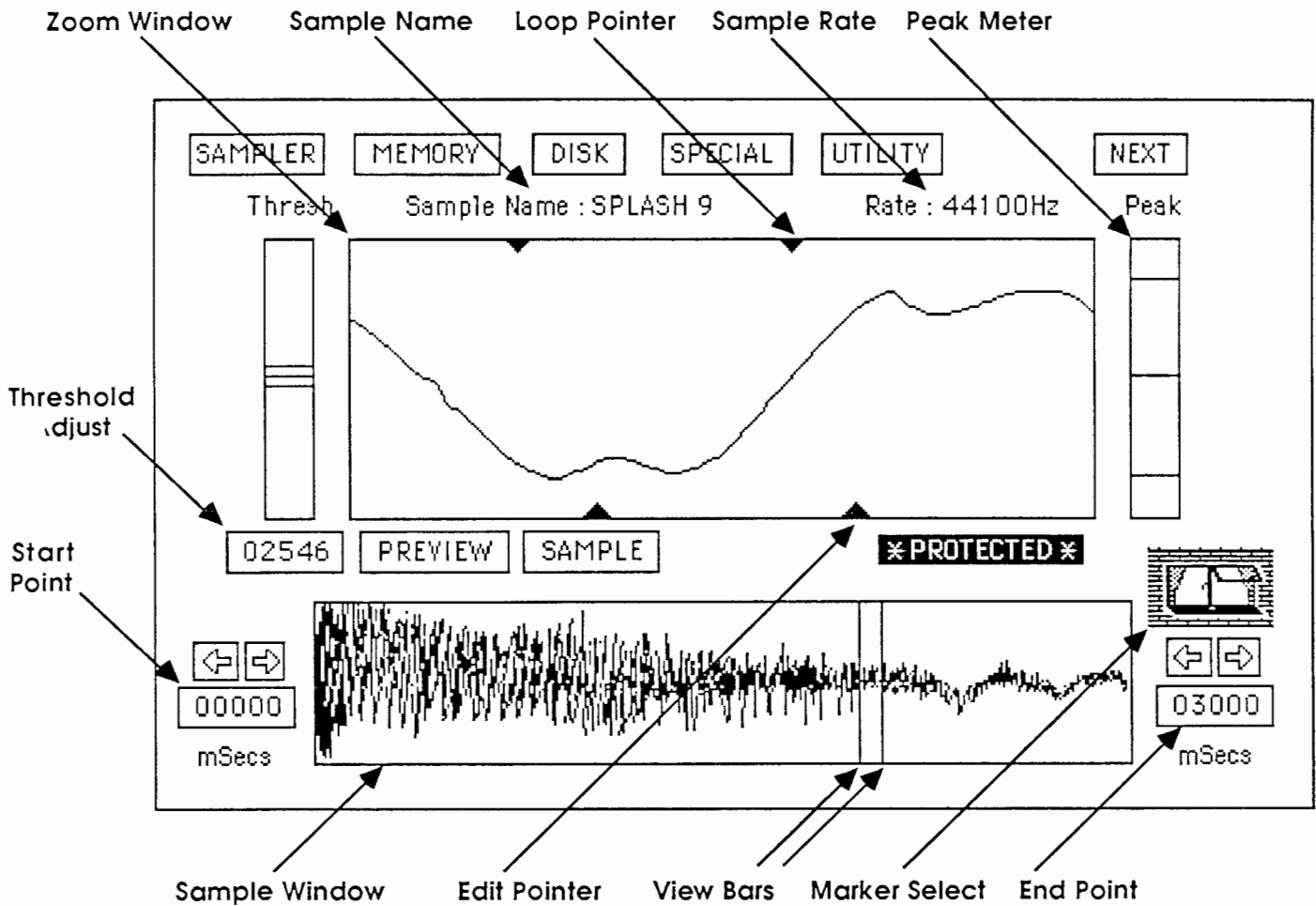

SCREEN PARAMETERS

Sample Name

Displays the name of the current Sample

Rate

Displays the selected Sample Rate.

Peak Meter

Displays the Peak value of the incoming signal, after Preview or Sample.

Threshold Adjust

Sets the amplitude at which the Sampler will be Triggered. The Threshold is adjusted by selecting the numeric box below the Threshold window and rolling the Tracker Ball upwards to increase, and downwards to decrease.

Sample Window

Displays the complete Sample.

View Bars

Allow a section of the Sample Window to be displayed in the Zoom Window.

Loop Pointers

Allow Start and End Points of a Loop to be defined.

Edit Pointers

Allow Start and End Points of an Edit to be defined.

Zoom Window

Displays a section of the Sample, defined by the View Bars in the Sample Window.

Preview

Clicking on Preview activates the Sampler continuously so that the incoming signal can be viewed on screen. Hold the select button to turn Preview off. The Sample will not be retained.

Sample

Clicking on Sample arms the Sampler. Once the incoming signal crosses the Threshold setting it will be activated. When the Sample Time has elapsed the new Sample will be displayed in the Sample Window.

Start Point

Selecting this numeric box allows the 3 Start Points, to be defined in milliseconds.

- When the the **Window** icon is selected the View Start Point, indicated by the left hand View Bar, can be defined.
- When the the **Loop** icon is selected the Loop Start Point, indicated by the upper left hand arrow, can be defined.
- When the **Edit** icon is displayed the Edit Start Point, indicated by the lower left hand arrow, can be defined.

End Point

Selecting this numeric box allows the 3 End Points, to be defined in milliseconds.

- When the the **Window** icon is selected the View End Point, indicated by the right hand View Bar, can be defined.
- When the the **Loop** icon is selected the Loop End Point, indicated by the upper right hand arrow, can be defined.
- When the **Edit** icon is displayed the Edit End Point, indicated by the lower right hand arrow, can be defined.

Sample Protection

When displayed, the current Sample is Protected and cannot be Edited. The protection can be turned off by clicking on **Protected** which opens the **Sample Protection Window** and Selecting **Protection Off**.

Marker Select

Clicking on the Marker Select icon allows access to the **View**, **Edit** and **Loop** Markers. A Window icon for View Markers, Scissor icon for Edit Markers and Loop icon for Loop Markers.

SAMPLER MENU

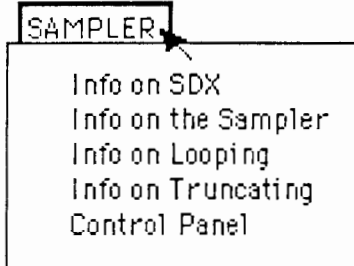

Info on SDX

Provides information about the SDX Console.

Info on the Sampler

Provides information about the Sampler Screen.

Info on Looping

Provides information about Looping Samples.

Info on Truncating

Provides information about Truncating Samples.

Control Panel

Selects the **Control Panel Window** allowing access to the 16 Pad Dynamic Meters, AutoTrigger, Key Pad modes and MIDIWatch facility.

MEMORY MENU

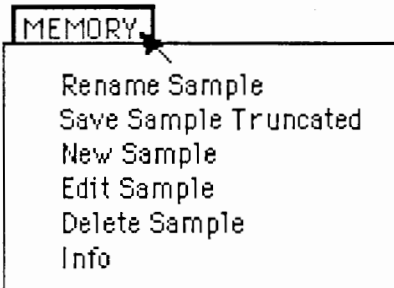

Rename Sample

Give the current Sample a new name. The **Keyboard Window** appears allowing the alternative name to be entered.

Save Sample Truncated

Save the Truncated Sample to Memory.

New Sample

Opens the **New Sample Window** allowing a new Sample Length or Sample Rate to be selected. The previous Sample will be cleared.

Edit Sample

Loads a Sample from Memory. The **Edit Catalog Window** will appear allowing the required Sample to be chosen from all the Samples currently in Memory. Once loaded this Sample will be Active, but will be protected.

Delete Sample

Deletes a Sample from Memory. The **Delete Catalog Window** will appear allowing the required Sample to be chosen from all the Samples currently in Memory.

Info

Selects the **Memory Information Window** showing which Kits, Drums and Samples are currently loaded and how much Memory space is left.

DISK MENU

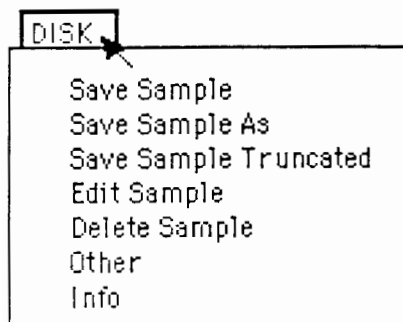

Save Sample

Saves to Disk any changes made to the current Sample.
Note : The Disk must be Unprotected.

Save Sample As

Save the current Sample to Disk with another name. The **Name Keyboard Window** appears allowing the new Sample to be named. If the name already exists the **Name Exists Window** appears allowing the Sample to be named again or the previous one to be overwritten. Once saved this Sample will be Active.
Note : The Disk must be Unprotected.

Save Sample Truncated

Save the Truncated Sample to Disk with another name. The **Name Keyboard Window** appears allowing the Truncated version to be named. If the name already exists the **Name Exists Window** appears allowing the Sample to be named again or the previous one to be overwritten. Once saved this Sample will be Active.

Note : The Disk must be Unprotected.

Edit Sample

Loads a Sample from Disk into Memory. The **Edit Catalog Window** will appear allowing the required Sample to be chosen from all the Kits currently on the Disk. Once loaded this Sample will be Active, but will be protected.

Delete Sample

Deletes a Sample from Disk. The **Delete Catalog Window** will appear allowing the required Sample to be chosen from all Samples currently on the Disk.

Note : The Disk in the Drive must be Unprotected.

Other

Provides a **Disk Operations Window**. This allows other Disk operations to be performed such as Loading any or all Kits, Drums, Samples or other data from Disk. Copy and Format options are also available.

Info

Selects the **Disk Information Window** showing the Kits, Drums and Samples currently on the Disk. The Disk Name, Serial No. and Type are also displayed along with the amount of free space remaining.

SPECIAL MENU

SPECIAL

- Loop Options
- Clear Samples Not In Window
- Reverse Samples In Window
- Maximise Sample Amplitude
- Protection

Loop Options

Opens a **Looping Options Window** which allows the best Loop Points to be found as well as the direction and number of loops chosen. Loop Gain Adjust and Cross Fade Looping can also be selected from this Window.

Clear Samples not in Window

Set the Sample outside the Zoom Window to zero. This selection will permanently effect the Sample in Memory.

Reverse Samples in Window

Reverse the Sample inside the Zoom Window. This will permanently effect the Sample in Memory.

Maximise Sample Amplitude

By Maximising the Sample, the gain is increased digitally giving the best Signal to Noise ratio through the system, without clipping. This will permanently effect the Sample in Memory.

Protection

Opens the **Sample Protection Window** allowing the Edit protection to be turned on or off.

UTILITY MENU

UTILITY

- Sine
- Hi Ramp
- Lo Ramp

Sine

Generates a Low-Frequency Sine Waveform Sample.

Hi-Ramp

Generates a High-Frequency Sawtooth Waveform Sample.

Lo-Ramp

Generates a Low-Frequency Sawtooth Waveform Sample.

NEXT MENU

NEXT

- Quit

Quit

Returns to the **Sample Assign Screen**. If any changes have been made to the Sample a **Save Changes Window** will appear. This allows any changes to be saved, lost or the Quit cancelled.

FUTURE UPGRADE

FUTURE UPGRADE

Creative Use of SDX

Interfaces

CONTENTS

MIDI	8 - 1
SCSI	8 - 3
SMPTE	8 - 5

TO BE RELEASED

TO BE RELEASED

TO BE RELEASED

Sound Disks

CONTENTS

Sound Disk #1	9 - 1
Sound Disk #2	9 - 3
Sound Disk #3	9 - 5
Sound Disk #4	9 - 7
Sound Disk #5	9 - 9
Sound Disk #6	9 - 11

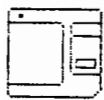





Sound Disk : Pre-Release
BRUFORD

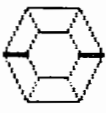

Kit Name : BRUFORDrto

MIDI Prog : No

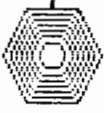
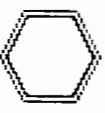
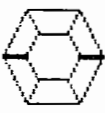
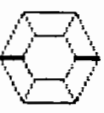
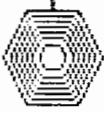
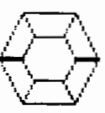
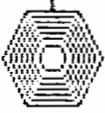
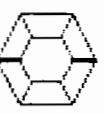
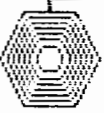
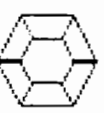
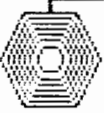
Number of Kits : 4
Drums : 17
Samples : 21

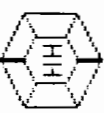
Pads 1 - 8	Drum Name	Sample Names	Comments	Pads 9 - 16	Drum Name	Sample Names	Comments
 Bass	BB bass 2	BrufBD		 Pad 9	logdrum	Bruflog dnm6	3 pitches of log drum. High in the centre of the pad.
 Snare	BB snare 2	BrufSnc BB snare 5	Bill's clamped snare - still rings a bit at the edge.	 Pad 10	metal	pitchCYM14	As 8, but tuned in the Mix.
 Rim	BB rtm	BrufSme		 Pad 11	templeblock	Temple Blck	
 Pad 4	BB roto hi	Brrotatm dc Brrotatm de	Bright Rototom, duller in the middle than the edge.	 Pad 12	Swell Gong	Bill CYM11cr	Long, slow attack gong.
 Pad 5	BB roto hi	Brrotatm dc Brrotatm de	As above, but tuned in the Mix.	 Pad 13	BBride 18"	Bill CYM2rdc Bill CYM2rde	Bell ride in centre of Symbal Pad. Light ride at edge.
 Pad 6	BB roto tom	Brrotatm dc Brrotatm de	As 4 & 5, but tuned lower and has slightly more bend.	 Pad 14	Phase Ride	Bill CYM2rdc Bill CYM2rde	As 13, but modulated in pitch to give a phasing effect.
 Pad 7	BB roto tom	Brrotatm dc Brrotatm de	As above, but tuned in the Mix.	 Pad 15	BB ride crsh	Bill CYM2rdc Bill CYM11cr	Ride in centre of Symbal Pad. Crash at edge.
 Pad 8	metal	pitchCYM4	Pitched cymbal, tuned low to sound metallic.	 Pad 16	BB hihat2	BB hhLsizz BB hh sizz BB hh c BB hh ped	Pedal open is more of a sizzle - sizzle shortens as pedal is closed.









Sound Disk : Pre-Release
BRUFORD

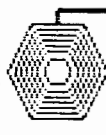
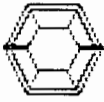
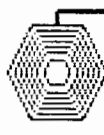

KIT Name : BRUFORD Logs

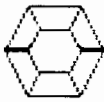
MIDI Prog : No

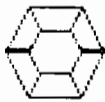
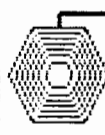
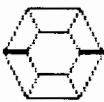
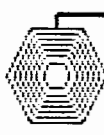
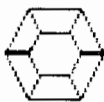
Number of Kits : 4
Drums : 17
Samples : 21

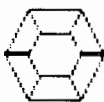
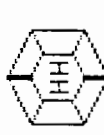
Pads 1 - 8	Drum Name	Sample Names	Comments	Pads 9 - 16	Drum Name	Sample Names	Comments
	BB bass 2		Tuned lower than Bruford roto		Finger Cym	Pitch CYM4	
	BB snare 3	BB ring C BB ring E	Undamped, Ringing Snare - TYPICAL!!		Finger Cym		
	BB rim 3	BB ring R	Ringing rim		Finger Cym		
	logdrum		3 Notes, tuned for scale with 5 below		Swell Gong		
	logdrum		3 Notes, tuned for scale with 4 above		Swell Gong		
	BB roto tom				Phase Ride		Higher tuned, ride cymbal
	BB roto tom				BB ride crash		Higher tuned, crash
	metal		tuned to match log drums		BB hi-hat 2		Higher tuned, hi-hat

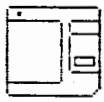



Sound Disk : Pre-Release
BRUFORD



KitName : BRUFORD kits

MIDI Prog : Mo

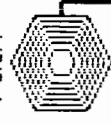
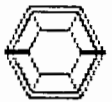
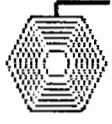
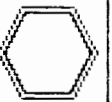
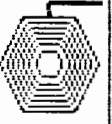
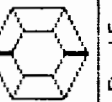
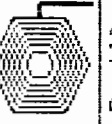
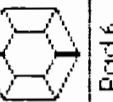
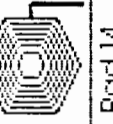
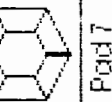
Number of Kits : 4
Drums : 17
Samples : 21

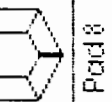
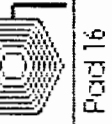
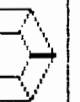
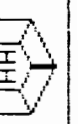
Pads 1 - 8	Drum Name	Sample Names	Comments	Pads 9 - 16	Drum Name	Sample Names	Comments
Bass 	BB Bass 2			Pad 9 	Logdrum		
Snare 	BB snare 3			Pad 10 	metal		
Rim 	BB rim 3			Pad 11 	Temple block		
Pad 4 	BB tom lo		un-damped low tom	Pad 12 	BB Ridecrash		
Pad 5 	BB tom lo		un-damped tuned lower	Pad 13 	BB Ridecrash		
Pad 6 	BB tom lo		un-damped tuned lower still	Pad 14 	BB Crash		
Pad 7 	BB tom lo		un-damped tuned even lower	Pad 15 	BB Ridecrash		
Pad 8 	metal			Pad 16 	BB Hi-Hat2		



Sound Disk : Pre-Release
BROAD





Kit Name : BROAD KIT 1A

MIDI Prog : 1

Number of Kits : 5

Drums :

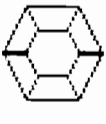
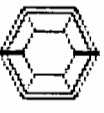
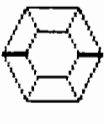
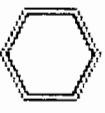
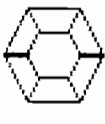
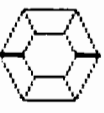
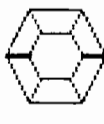
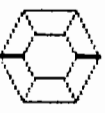
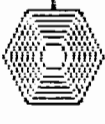
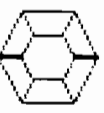
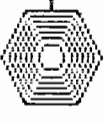
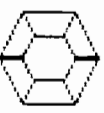
Samples :

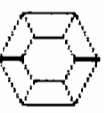
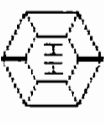
Pad 1 - 8	Drum Name	Sample Names	Comments	Pads 9 - 16	Drum Name	Sample Names	Comments
Bass 	GB bass 2		Power Bass with Heavy Filter	Pad 9 	block 1		Wood block sampled with Ambience. Sample switching across Pad.
Snare 	GB snare 6		Rock Snare	Pad 10 	block 2		As above, de-tuned
Rim 	GB rim 12		Text	Pad 11 	cow 1		Cowbell sampled with slight Ambience. Sample Switching.
Pad 4 	GB tom m		Heavy Tom with Snare Buzz	Pad 12 	cow 2		Cowbell sampled with slight Ambience. Sample Switching.
Pad 5 	GB tom n		Heavy Tom with Snare Buzz	Pad 13 	GB crash		
Pad 6 	GB tom l		Heavy Tom with Snare Buzz	Pad 14 	GB ride		
Pad 7 	GB tom l		Heavy Tom with Snare Buzz	Pad 15 	GB china boy		
Pad 8 	GB tom l		Heavy Tom with Snare Buzz	Pad 16 	GB HiHat 2		



SoundDisk : Pre-Release
BROAD

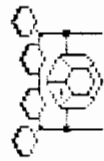







KitName : BROAD KIT 2a

MIDI Prog : 2

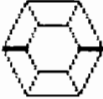
Number of Kits : 5

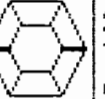
Drums :

Samples :

Drum Name	Sample Names	Comments	Pads 9 - 16	Drum Name	Sample Names	Comments
GB bass 12		Tight Rock Bass Drum	Pad 9 	bongo 1		High tuned ambient bongo
GB snare 4		Very playable Snare, light airy sound.	Pad 10 	bongo 1		low tuned ambient bongo
GB rim 10		Ringy rim with snares buzzing.	Pad 11 	cow 1		low-tuned cowbell
GB tom b		Very natural tom, lots of ring	Pad 12 	block 1		Ambient wood block
GB tom b		Very natural tom, lots of ring	Pad 13 	GB crash 1		
GB tom c		Very natural tom, lots of ring	Pad 14 	GB china 3		
GB tom d		Very natural tom, lots of ring	Pad 15 	GB ride 3		
GB tom e		Very natural tom, lots of ring	Pad 16 	GB HHat 2		

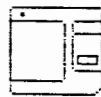









Sound Disk : Pre-Release
BROAD

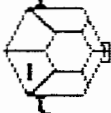
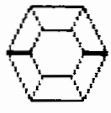

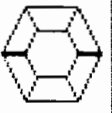
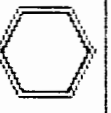
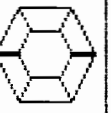
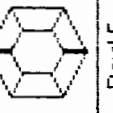
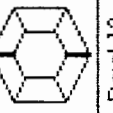
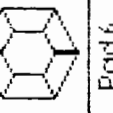
Kit Name : BROAD KIT 2j

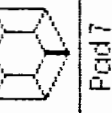
MIDI Prog : 3

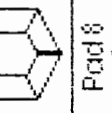
Number of Kits : 5
Drums :
Samples :

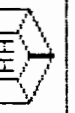
Pads 1 - 8	Drum Name	Sample Names	Comments	Pads 9 - 16	Drum Name	Sample Names	Comments
Bass 	Jazz bass 1		Tight Thumpy Bass	Pad 9 	bongo 1		High tuned ambient bongo
Snare 	GB snare 4		Very playable Snare, light oily sound.	Pad 10 	bongo 1		low tuned ambient bongo
Rim 	GB rim 10		Ringy rim with snares buzzing.	Pad 11 	cow 1		low-tuned cowbell
Pad 4 	GB tom b		Very natural tom, lots of ring	Pad 12 	block 1		Ambient wood block
Pad 5 	GB tom b		Very natural tom, lots of ring	Pad 13 	GB crash 1		
Pad 6 	GB tom c		Very natural tom, lots of ring	Pad 14 	GB china 3		
Pad 7 	GB tom d		Very natural tom, lots of ring	Pad 15 	GB ride 3		
Pad 8 	GB tom e		Very natural tom, lots of ring	Pad 16 	GB HiHat 2		













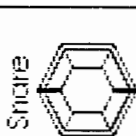

Sound Disk : Pre-Release
BROAD

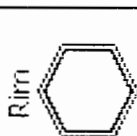
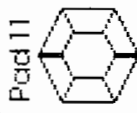
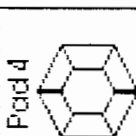

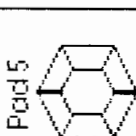
KitName : BROAD KIT 3a

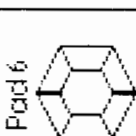
MIDI Prog : 4

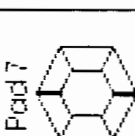
Number of Kits : 5
Drums :
Samples :

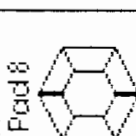
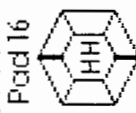
Pads 1 - 8	Drum Name	Sample Names	Comments	Pads 9 - 16	Drum Name	Sample Names	Comments
	GB bass 21		Thumpy bass with ambience and snare buzz	Pad 9 	cow 1		Cowbell
	GB snare 6		Rock Snare	Pad 10 	cow 1		Cowbell
	GB rim 12		Short Rimshot with Pitch bend	Pad 11 	cow 1		Cowbell
Pad 4 	bongo 1		Ambient bongo high	Pad 12 	cow 1		Cowbell
Pad 5 	bongo 1		Ambient bongo low	Pad 13 	gb gong 1		Slow rise-fine crash
Pad 6 	Hook tom 4a		Ambient tom	Pad 14 	GB chind 2		
Pad 7 	Hook tom 4a		Ambient tom	Pad 15 	GB ride		
Pad 8 	Hook tom 4a		Ambient tom	Pad 16 	GB HiHat		

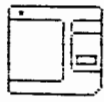

Sound Disk : Pre-Release
BROAD









KitName : BROAD KIT 4a

MIDIProg : 5

Number of Kits : 5

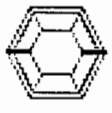
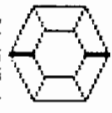
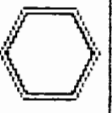
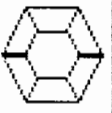
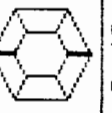
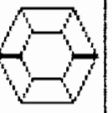
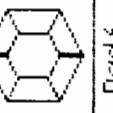
Drums :

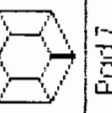
Samples :

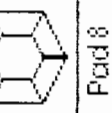
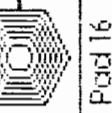
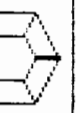
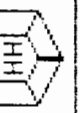
Pads 1 - 8	Drum Name	Sample Names	Comments	Pads 9 - 16	Drum Name	Sample Names	Comments
Bass 	GB bass 4			Pad 9 	bongo 1		Ambient bongo
Snare 	GB snare 5		Very snappy Snare	Pad 10 	bongo 1		Ambient bongo
Rim 	cow 1		Cowbell on rim	Pad 11 	cow 1		Cowbell
Pad 4 	Hook tom 4a		Ambient tom	Pad 12 	block 1		woodblock
Pad 5 	Hook tom 4a		Ambient tom	Pad 13 	gb crash 2		
Pad 6 	Hook tom 4a		Ambient tom	Pad 14 	GB crash 1		
Pad 7 	Hook tom 4a		Ambient tom	Pad 15 	block 1		woodblock with sample switching
Pad 8 	Hook tom 4a		Ambient tom	Pad 16 	GB HiHat 2		

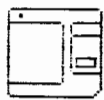

SoundDisk : Pre-Release
JAZZ

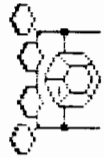









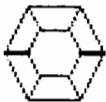

KitName : Jazz ring

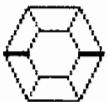
MIDIProg : 6

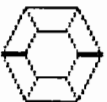
Number of Kits : 2

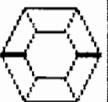
Drums :

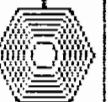
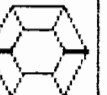
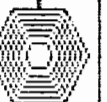
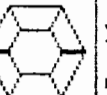
Samples :

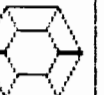
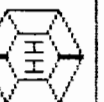
Pad 1 - 8	Drum Name	Sample Names	Comments	Pads 9 - 16	Drum Name	Sample Names	Comments
Bass 	Jazz bass 1		Tight bass no ring	Pad 9 	Anvil		
Snare 	Jazz snuff		No Snare lots of ring	Pad 10 	clave 1		
Rim 	Jazz rim		Ringly	Pad 11 	Maraca 1		
Pad 4 	Jazz tom 1			Pad 12 	Maraca 1		
Pad 5 	Jazz tom 1			Pad 13 	Hookride 2		
Pad 6 	Jazz tom 1			Pad 14 	Hookride 2		
Pad 7 	Jazz tom 1			Pad 15 	Hookride 2		
Pad 8 	Jazz tom 1			Pad 16 	Hook Hat 2		

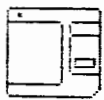

Sound Disk : Pre-Release
JAZZ



KitName : Jazzing 2

MIDI Prog : 7

Number of Kits : 2

Drums :

Samples :

Pad 1 - 8	Drum Name	Sample Names	Comments	Pad 9 - 16	Drum Name	Sample Names	Comments
Bass 	Jazz bass 1			Pad 9 	Anvil		
Snare 	Tin SNR 1		Lots of ring, very metallic	Pad 10 	Gong slap		
Rim 	Hook RIM 3			Pad 11 	Maraca 1		
Pad 4 	Jazz tom 1a			Pad 12 	Clave 1		
Pad 5 	Jazz tom 1a			Pad 13 	Hook ride 2		
Pad 6 	Jazz tom 1a			Pad 14 	Hook ride 2		
Pad 7 	Jazz tom 1a			Pad 15 	Hook ride 2		
Pad 8 	Jazz tom 1a			Pad 16 	Hook Hat 2		

Appendix

CONTENTS

MIDI Implementation Chart	10 - 1
Specification	10 - 3
Electrical	10 - 3
Inputs	10 - 3
Outputs	10 - 3
Processor Boards	10 - 4
Floppy Disk Drive	10 - 5
Hard Disk/SCSI Port	10 - 5
Tracker Ball	10 - 5
Credits	10 - 7

MIDI Implementation

MODEL: Simmons SDX

MIDI Implementation Chart

Date:
Version: 1.0

Function...		Transmitted	Recognized	Remarks
Basic Channel	Default Channel	Yes	Yes Programmable	Channels 1-16
Mode	Default Messages Altered	N/A	N/A	Omni on/off
Note Number	True Voice	Yes Programmable	Yes Programmable	Notes 0-127 for each drum pad
Velocity	Note ON Note OFF	Yes	Yes	Note off on internal Gate time or by damp with damp velocity
After Touch	Key's Ch's	No	No	
Pitch bender		Yes	Yes	
Control Change		Yes	Yes	See separate sheet
Prog Change	True #	Yes	Yes	Programmable per kit
System Exclusive		Yes	Yes	Sample dump standard
System	:Song Pos :Song Sel :Tune	-	-	For future update
System Real Time	:Clock :Commands	N/A	N/A	For future update
Aux Messages	:Local ON/OFF :All Notes Off :Active Sense :Reset	N/A	N/A	
Notes				

Creative Use of SDX _____

ELECTRICAL

Mains Voltage: 90 - 130v or 180 - 260v Externally selected.
Mains fuse: 2.5 Amps @ 240v, 5 Amps @ 120v Anti-Surge
Mains frequency: 50 - 60 Hz

INPUTS

Pad

Bass Pad: Mono 1/4" Jack
Snare Pad: Stereo 1/4" Jack
Rim: Mono 1/4" Jack
Pads 4 - 16: Stereo 1/4" Jack.

Lead for Snare Pad is 4 pin XLR to Stereo and Mono Jacks.

Pedal

Hi-Hat Pedal: Mono 1/4" Jack
Mod Pedal : Stereo 1/4" Jack
L/R Pedal: Stereo 1/4" Jack

Sampler

Balanced Input on Stereo 1/4" Jack

Chassis : GND
Ring : -ve
Tip : +ve

Level +4dBm for full scale conversion
11 pole 20KHz anti-aliasing filter on input.

MIDI

MIDI IN
5 pin DIN socket with Opto-Coupler

Pin 4: MIDI +
Pin 5: MIDI -

SMPTE

Mono 1/4" Jack
Impedance 10k Ω

OUTPUTS

Individual Voice Outputs

Mono 1/4" Jacks
Peak Level +4dBm

Snare Output

Mono 1/4" Jack

Peak Level +4dBm

Mix of Individual Voices 2,3 and 4

Stereo Output

Stereo 1/4" Jack

Peak level +4dBm

Mix of all 16 Voices

Headphones

Stereo 1/4" Jack

Impedance 600Ω

Adjustable level from -20dB to 0dB

MIDI

MIDI THRU, MIDI OUT

5 pin DIN socket

Pin 4 MIDI +

Pin 5 MIDI -

SMPTE

Mono 1/4" Jack

Impedance 2kΩ

Video

EIA - RS - 170 standard Composite Video

PROCESSOR BOARDS

System Board

68000 Processor

64 kB Program Memory

192 kB Program / Data Memory

2MB (min) to 8MB (max) Sample Memory

Custom 18 channel DMA controller

Video / MIDI / SMPTE Board

9995 Video Processor

8031 Processor

256kB Video Memory and Sequencer buffer

64kB Program Memory

Video configuration: 512 pixels by 256 lines

9" Green Phosphor Monitor

Voice Board (2 off)

9995 Voice Processor
32kB Data Memory
64kB Program Memory
8 channels, each of which contains:
16 bit Digital-Analogue sample conversion
Signal-Sample mixing
3 pole Reconstruction Filter
4 pole Music Filter with Resonance
Envelope , Channel Volume and Pan VCA's
5 point Envelope Generators for:
Pitch, Brightness, Resonance, Noise, Level and Pan

Pad Board

8031 Processor
8kB Data Memory
16kB Program Memory
14 ZI Pad input analogue channels
Bass, Rim, Hi-Hat & Pedal input channels.

FLOPPY DISK DRIVE

Sony 2MB 3.5" Drive
2MB/1MB disks automatically selected
512 Bytes/Sector

HARD DISK / SCSI PORT

Optional Rodime 20MB 3.5" Winchester. (SCSI)
Additional SCSI port on 50 way connector.

Current Software implementation allows up to 7 external Hard
Disks to be connected.

TRACKER BALL

Optical Mechanism with 13 Slot Rotors

CONCEPTUAL DESIGN

| David Simmons
Simon Davidmann

HARDWARE DESIGN

| David Simmons
Jim Lindop

SOFTWARE DESIGN

| Simon Davidmann
Julian Hall
Martin Weetman

MECHANICAL DESIGN

| David Simmons
Tony Beddoe

PRODUCTION ENGINEERING

| Kevin Anderson
Jim Pinnock

USER MANUAL

| Kenneth McAlpine

Creative Use of SDX - V1.2 Update Notes.

Since this User Manual was printed, a number of changes have been made to the System Software, released as V1.2. The updated features are listed below.

Section 3 - Getting Started

3-4 The current Software Version 1.2 is shown at the bottom of the Welcome Screen.

3-6 Kit Select Menu Choose Info
 Control Panel

3-7 The Help System has been changed into a Global System, that is you can access information on any subject from all the Screens, not just those related to the Screen you are on.

When you select **Choose Info** from the Kit Select Menu, you will open a Choose Info On ... Window, presenting you with all the topics available. Insert your Help Disk and Click on the topic you require information on.

A Help System Window will then be displayed. When you Quit from this Window, you will return to the Choose Info On ... Window, allowing you to select another topic.

Click Quit on this Window to return to the Kit Select Screen.

3-9 The Disk Menu now has a new option: **Clear Memory and Load All Kits**. This allows you to remove all the Kits, Drums and Samples currently in Memory and Load all of the Kits from the current Disk. Two Warning Windows will appear allowing you to cancel the option before the Memory is erased.

3-10 A **Special Menu** option - **Raw Sampling** allows you to transfer directly to the Sampler Screen without going through the normal route.

See Page 4-78 for a description of how to make new Samples. Also, see the notes 4-79 below, for a description of the new Sampler features.

The Sample you create can be played using Pad 1, the right-hand select button or the Note icon.

Quitting from a Sampler Screen invoked by Raw Sampling will return you directly to the Kit Select Screen.

4 - 12 MIDI Program Changes are transmitted on the Bass Pad's channel only.

4 - 15 The **Pad Type as Default** option now configures the Pads as follows :

Pad 1 - Bass	Pad 9 - Symbal
Pad 2 - Snare	Pad 10 - Symbal
Pad 3 - Rim	Pad 11 - Symbal
Pad 4 - Tom	Pad 12 - Symbal
Pad 5 - Tom	Pad 13 - Symbal
Pad 6 - Tom	Pad 14 - Symbal
Pad 7 - Tom	Pad 15 - Symbal
Pad 8 - Tom	Pad 16 - Hi-Hat

4 - 16 The **Kit/Drum Assigning** Window now has another option, **New Drum**, see 4 - 31.

4 - 19 The **Voice Assign as Default** option now configures the Voices as follows :

Pad 1 - Voice 1	Pad 9 - Voices 10 - 16
Pad 2 - Voices 2,3,4	Pad 10 - Voices 10 - 16
Pad 3 - Voice 5	Pad 11 - Voices 10 - 16
Pad 4 - Voices 6,7,8,9	Pad 12 - Voices 10 - 16
Pad 5 - Voices 6,7,8,9	Pad 13 - Voices 10 - 16
Pad 6 - Voices 6,7,8,9	Pad 14 - Voices 10 - 16
Pad 7 - Voices 6,7,8,9	Pad 15 - Voices 10 - 16
Pad 8 - Voices 6,7,8,9	Pad 16 - Voices 6,7

4 - 22 When the Pad type is **Pitched** and a **MIDI Note Range** is displayed, MIDI Notes received at MIDI In will pitch the Drum, provided they are within range. MIDI Notes transmitted from MIDI Out will not change with Position, as stated. Only the Lower Note of the Range will be transmitted.

4 - 24 When MIDI Notes are displayed, Middle C=60 or C5.

4 - 25 When you select **Save Kit** to save your Changes, a **Name Exists Window** will open. Click on **Replace** to overwrite the current Kit.

4 - 31 The **Kit/Drum Assigning** Window now has another Edit option, **New Drum**.

This provides you with an easy way to create a New Drum. When you click this option a **Select Drum Type** Window will appear, allowing you to select the type of Drum you want to create.

When you select a Drum Type, **Drum Head** parameters suitable to that type of Drum, will be loaded and the Sample Assign Screen will be displayed with a Blank Drum. This saves you from having to set up Drum Head parameters, each time you create a New Drum. You can of course edit the Drum Head later, once you have created the Sample Assignment you want.

The **New Drum** option can also be invoked from the Memory Menus of the Sample Assign and Drum Head Screens.

4 - 35 **Level Offsets** are not implemented in V1.2 and have no effect.

4 - 46 A **Minimum Dynamic** has been added to the Hi-Hat's Sample Assign Screen. This effects the level produced by the Pedal Trigger, ranging from 1 to 127. The default value is 95.

4 - 61 The Preset Envelope Shapes in the Surface Window are different from those shown in the Manual.

4 - 69 You cannot move **Pan Soft**/Centre co-ordinate. The Initial Pan Position is defined by the setting on the Mixer Screen.

4 - 79 Four new icons have been added to the **Sampler Screen**.

By clicking on the Note icon, to the right of the Peak Meter, the current Sample can be triggered. The right-hand Select Button will perform the same function.

The Arrow icon, under the Zoom Window, shows the current Loop Direction.

Clicking on the icon will alternate it between an arrow pointing to the right representing Forward looping, and a two headed arrow representing Backward/Forward looping.

The FLP box allows the Find Loop Points function to be activated. This performs the same function as clicking the Find Loop Points box in the Looping Options Window.

The numeric box next to FLP sets the number of Loops. Setting a number of Loops here performs the same function as setting it in the Looping Options Window.

4 - 95 The Maximise Sample Amplitude option from the Special Menu, now allows you to adjust the amount of Gain, where 0dB is full Range:

You can set the amount of Gain from -99 to +99 dB

4 - 101 The **Disk Operations Window** now has an INFO box. Click on this box to transfer to the **Disk Info Window**. The Disk Operations Window will be displayed again when you click Quit on the Disk Info Window. This feature allows you to check the Disk contents before carrying out any of the Other Disk Operations.

4 - 102 If the current Device is the Internal Drive it will be displayed as /floppy, not Int Floppy. An Internal Hard Disk it will be displayed as scsi1, not Hard Disk.

4 - 111 The Rename option now includes **Disk** as an Item Type, allowing you to rename a floppy Disk or Disk Slot.

4 - 114 When the current Disk is a Floppy, the Format option will not have a Quantity or Item Type. For a Hard Disk there will be a Quantity. **One** to Format a Disk Slot and **All** to Format the Disk.

4 - 125 Only Program Changes are displayed in MDIWatch.

5 - 2 The Kit Select Screen has the following Menus changed :

Kit Select Menu	Choose Info Control Panel
Memory Menu	Clear Memory Delete Kit Info
Disk Menu	Clear Memory and Load All Kits
Special Menu	Raw Sampling

5 - 6 The Kit Mixer Screen has the following Menus changed :

Kit Mixer Menu	Choose Info Control Panel
----------------	------------------------------

5 - 11 The Kit Configuration Screen has the following Menus changed :

Kit Configuration Menu	Choose Info Control Panel
Memory	New Kit has been Removed

5 - 18 The Sample Assign Screen has the following Menus changed :

Drum Sample Assign	Choose Info Control Panel
--------------------	------------------------------

5 - 18 Memory Menu - **New Drum** is implemented.

5 - 22 The Drum Head Screen has the following Menus changed :

Drum Head Menu	Choose Info Control Panel
----------------	------------------------------

5 - 22 Memory Menu - **New Drum** is implemented

5 - 27 The Sampler Screen has the following Menus changed :

Sampler Menu	Choose Info Control panel
--------------	------------------------------

5 - 27 **Save Sample Truncated to 2nd Loop Point** has been added to the Memory Menu. See Page 4 - 88.

Save Sample Truncated to 2nd Loop Point has been added to the Disk Menu. See Page 4 - 88.